

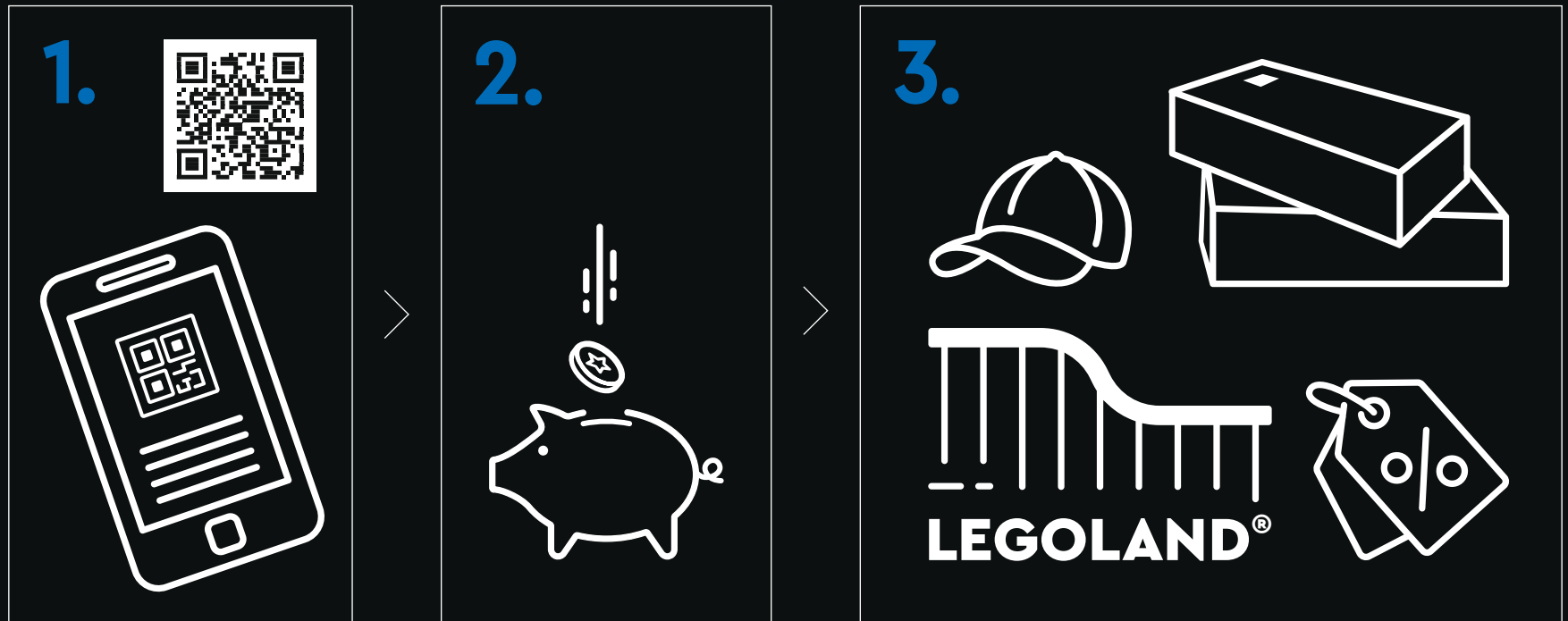



[LEGO.com/sustainable-packaging](https://www.lego.com/sustainable-packaging)

LEGO® VIP



1. Sign up **2.** Earn points for purchases **3.** Redeem points for rewards, experiences, discounts & more | **1.** Melde dich an **2.** Sammle Punkte bei jedem Kauf **3.** Löse die Punkte für Belohnungen, Erlebnisse, Rabatte und Ähnliches ein | **1.** Inscrivez-vous **2.** Gagnez des points lors de vos achats **3.** Échangez vos points contre des récompenses, des expériences, des remises et bien plus encore | **1.** Iscriviti **2.** Guadagna punti con i tuoi acquisti **3.** Riscatta punti per premi, esperienze, sconti e altro ancora | **1.** Regístrate **2.** Gana puntos por tus compras **3.** Canjea puntos por recompensas, experiencias, descuentos y mucho más | **1.** Registe-se **2.** Ganhe pontos em compras **3.** Troque os pontos para prémios, experiências, descontos e muito mais | **1.** 注册 **2.** 购物赚积分 **3.** 用积分兑换奖励、体验、折扣等 | **1.** Zarejestruj się **2.** Zdobywaj punkty za zakupy **3.** Wymieniaj punkty na rabaty, przygody i inne nagrody | **1.** Zaregistrujte se **2.** Sbírejte body za nákupy **3.** Vyměňujte body za odměny, zážitky, slevy a spoustu dalšího | **1.** Zaregistrujte se **2.** Získavajte body za nákupy **3.** Uplatnite si body a získajte odmeny, rôzne zážitky, zľavy a ešte viac | **1.** Regisztrálj **2.** Szerezz pontokat minden vásárlással **3.** Váltsd be pontjaidat jutalmakra, élményekre, kedvezményekre és egyebekre | **1.** Înscric-te **2.** Câștigă puncte pentru achiziții **3.** Valorifică puncte pentru recompense, experiențe, reduceri și multe altele | **1.** Регистрируйте се **2.** Получайте точки за покупки **3.** Используйте точки за награды, услуги, отстъпки и т.н. | **1.** Reģistrējies **2.** Pelni punktus par pirkumiem **3.** Izmanto punktus, lai saņemtu balvas, izklaides iespējas, atlaides un daudz ko citu | **1.** Registreeru **2.** Teeni ostude eest punkte **3.** Lunasta punktide eest preemiad, elamused, allahindlused ja muu | **1.** Užsiregistruokite **2.** Pelnykite taškų už pirkinius **3.** Panaudokite taškus atlygiui, funkcijoms, nuolaidoms ir ne tik



W.



粉丝设计师访谈录

E

法国导演兼编剧 Thomas Lajon (乐高®创意 LEGO® Ideas 用户名 LEt.sGO) 在四岁时就得到了他的第一款乐高套装, 并且现在仍喜欢拼搭。今天, 他将与粉丝们分享他的乐高激情 (和积木)。

“我一直是火车的忠实粉丝, 如果能回到过去 (并且买得起票), 我会乘坐东方快车! 它仿佛来自另一个世界, 这就是我喜欢它的原因。在近一个世纪的时间里, 这列豪华列车用奢华的车厢载着乘客横贯欧洲, 并且一直是许多故事和神话的主题。对于我这个从事编剧和电影工作的人来说, 东方快车可以激发冒险故事灵感, 点燃旅行热情。东方快车是梦之列车, 其富丽堂皇的车厢由出色的工匠和设计师创造。它有一种难以接近的气息, 能够满足我们的幻想。它属于精彩绝伦的故事、文学、歌曲和电影。”

“这款模型是我的第一个乐高创意 LEGO Ideas 项目, 花费了数小时、数个日夜的准备、设计和耐心! 我通过查看太平洋 231 K 8 号火车头的图片, 以及数百张车厢内外部图片来拼搭我的模型。最终的套装非常漂亮, 乐高设计师团队非常出色地实现了这个梦想。我最喜欢的细节是凸面镜, 它能够反射出卧铺车厢的内部细节。对我来说, 这是锦上添花。我想向 10000 名乐高创意 LEGO Ideas 支持者中的每一位表达我的想法, 并感谢他们让这一幸福时刻成为现实!”



Thomas 提交的原创作品

S

为新世界铺平道路



在工业革命期间，火车和铁路成为技术进步和政治权力的象征。不同地区之间涌现出长达数千英里的新轨道和路线，它们穿越边界，带来了新的生活。它们促进了货物的高效运输、经济增长和异国旅行，带来了新的就业机会，为全球数百万人提供了便利。当时国际旅行仍处于起步阶段，

跨国界协调较少或效率较低。随着政治紧张局势蔓延到整个欧洲，比利时的中立地位将在为全球进步铺平道路方面发挥重要作用，因为该国铺设了通往欧洲大陆大部分地区和殖民地的具有重要战略意义的铁路。

外交突破

- 1876年，富有远见的比利时工程师和企业家 Georges Nagelmackers 创立了国际卧铺车公司 (International Sleeping-Car Company, CIWL)。他看到了豪华旅行的潜力，该项目非常符合上层阶级的口味。受到美国越来越受欢迎的餐饮和卧铺车厢的启发，他率先打造了第一列豪华列车，而该想法最终风靡全球。通过错综复杂的外交谈判以及无与伦比的毅力和乐观精神，Nagelmackers 赢得了邻国的必要许可和合同，使他的火车能够畅通无阻地穿越欧洲，从巴黎一直到君士坦丁堡。这列火车的设计、施工和维护是品质、完美和创新的绝对巅峰，由世界各地的才俊监督。最重要的是，新列车拉近了有趣而浪漫的新视野，将新的梦想变为现实，并打开了通往新世界的大门。



E

冒险之门

- 奥斯曼帝国的首都通往神秘而充满魅力的远东的门户，已成为欧洲艺术家和作家新的热门目的地和灵感来源。作为第一列横贯欧洲大陆的列车，东方快车没有辜负其冒险旅行的承诺。火车本身就是 Nagelmackers 新公司的旅行广告，各种广告活动包括彩色海报、明信片 and 具有收藏价值的纪念品。所有这些物品都带有奥斯曼地标和象征的图像，沙色和构图，或者身穿埃及或阿拉伯风格服装的模特。该公司的官方 Wagons-Lits 杂志不但推广娱乐路线和用品，而且刊登了名人享受火车上奢侈服务的照片，从豪华的餐饮和卧铺车厢到衣着一尘不染的行李搬运工和列车员，令东方快车的魅力、神话和独特性永存。



如果这些火车车厢会说话.....



在 1883 年 10 月东方快车成功完成处女之旅后，国际卧铺车公司在接下来的几十年中不断增加新路线，一直延续到 20 世纪。正如 Nagelmackers 所预见的那样，人们被冒险体验的品质、奢华和承诺所吸引。但东方快车的
关键转折点出现在 1934 年。阿加莎·克里斯蒂的

畅销小说《东方快车谋杀案》的发行使这列火车成为公众焦点，充满魅力、激动和神秘感，并将其作为 20 世纪的一种文化现象推向世界舞台。一个现代传奇诞生了。即使在四十年之后，第一部改编电影仍能令新观众沉浸于其中。

N

变革时代的东方快车

1867 年

在美国旅行期间，Georges Nagelmackers 发现了现代餐车和卧铺车，并看到了它们重新定义旅行的潜力。

1883 年

10 月 4 日，东方快车开启了它的处女之旅——从巴黎到君士坦丁堡的往返旅行，于 10 月 16 日返回。二十几名乘客被邀请参加了这次前往黑海沿岸的“新闻之旅”，此次旅程的最后部分由汽船完成。

1889 年

东方快车 现在通过布达佩斯、贝尔格莱德和索非亚连接巴黎和君士坦丁堡，耗时 67 小时 46 分钟。

1918 年

传说 1918 年的停战协议是在东方快车上签署的。事实上，停战协议是在该公司另一列火车的车厢中签署的：位于贡比涅森林 (forest of Compiègne) Rethondes 空地上的 2419 号餐车。

1919 年

从伦敦和巴黎经意大利到君士坦丁堡的辛普伦-东方快车开行仪式。这条路线是盟国之间的合作倡议，反映了第一次世界大战后欧洲新的地缘政治形势。





穿越时空，重温东方快车历史上的标志性时刻。

1922 年

在第一次世界大战期间许多被摧毁或没收的车厢需要维修或更换。柚木适时取代了钢，车厢采用了标志性的深蓝色涂装。

1929 年

一场暴风雪将东方快车困在土耳其小镇 Cherkeskoy 多日。该事件为阿加莎·克里斯蒂的经典作品《东方快车谋杀案》（1934 年发行）带来了灵感。

1934 年

阿加莎·克里斯蒂的畅销小说《东方快车谋杀案》发行，小说以虚构的比利时侦探赫尔克里·波洛 (Hercule Poirot) 为主角。该小说将此列车的知名度推上了新高度，并使其成为文化象征。

1946 年

在第二次世界大战期间整个欧洲的服务中断后，到伊斯坦布尔的路线终于恢复。

1974 年

第一部根据阿加莎·克里斯蒂的《东方快车谋杀案》改编的电影在全球首映，并将继续成为现代经典。

1977 年

面对现代豪华航空旅行的激烈竞争，东方快车于 5 月 20 日最后一次开往伊斯坦布尔。



- “Thomas 的原创作品在准确性和细节方面更上一层楼——确实展现出了他对蒸汽时代的热情。我们全力以赴，旨在最终的乐高®模型中展现出世界级豪华旅行的原始体验。我们设计了餐车和卧铺车，并且经过广泛的研究和与专家咨询后，我们能够以乐高方式重现系列细节，如原始服务中看到的木饰面镶板和雕花玻璃镜。我希望我们的乐高火车粉丝能找到很多专为此套装制作的令人念想的组件。为火车头连接杆制作的全新梁组件、用于汽笛的笔，以及用于烟囱的桶，只是我最喜欢的几个。这款模型比传统的乐高火车要大，这意味着内部有额外的空间来展示细节，当然还有玩乐！”

—Ollie Gregory,
乐高®创意 LEGO® Ideas 高级模型设计师

乐高®设计师访谈录



“Thomas 的模型是一款真正怀旧的套装，非常出色！我非常喜欢木制面板、玻璃、凸面镜、带鸟的镜子，以及所有受原创启发的细节。我们希望这些装饰能够真正令内饰惟妙惟肖，并增添一些乐高®风格。所有的鸟儿、花和树叶都由乐高组件拼搭而成，但要找到合适的色彩和细节组合仍然是一个难题，为了解决它，我们测试了许多设计、印花、徽标和字体。另一个总是很有趣而又具有挑战性的部分是

新小人仔的设计。东方快车在流行文化中极具标志性，因此我们准备了一个有趣的角色阵容，可供你来创造属于自己的故事，这些角色包括新服务员、记者，以及列车员、消防员、礼宾员、行李搬运工、尊贵的公爵夫人、科学家等。我希望这款套装能够激发你的想象力！”

—Kjeld Walther Sørensen,
乐高®创意 LEGO® Ideas 美术设计师

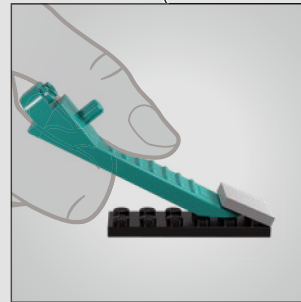
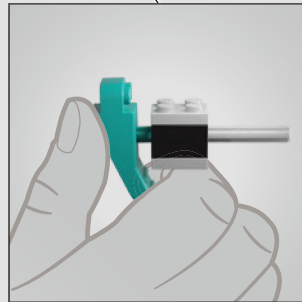
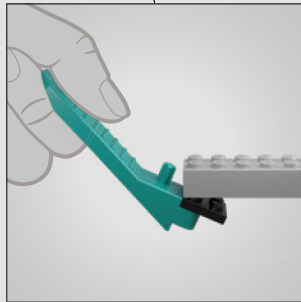
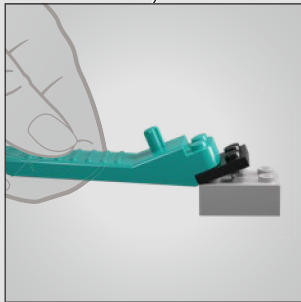
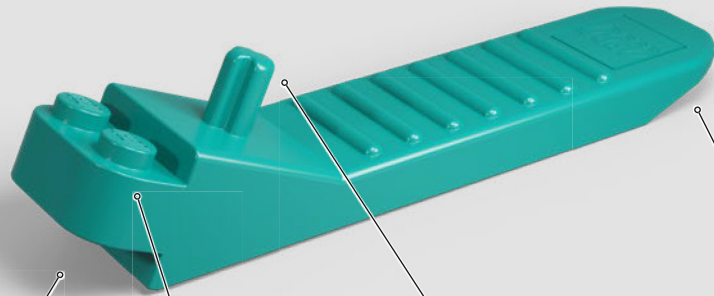

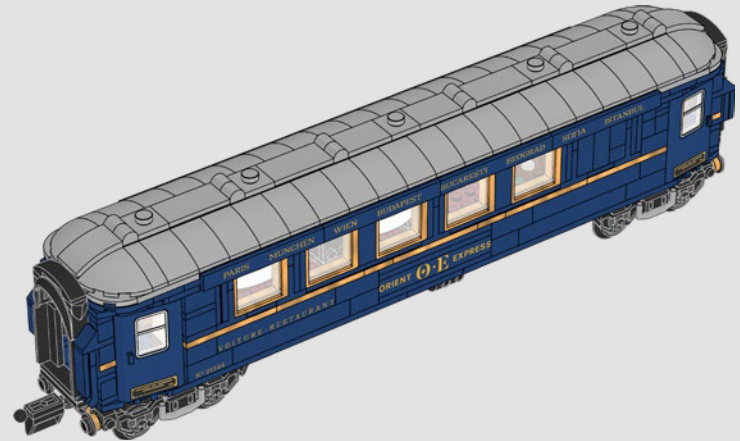
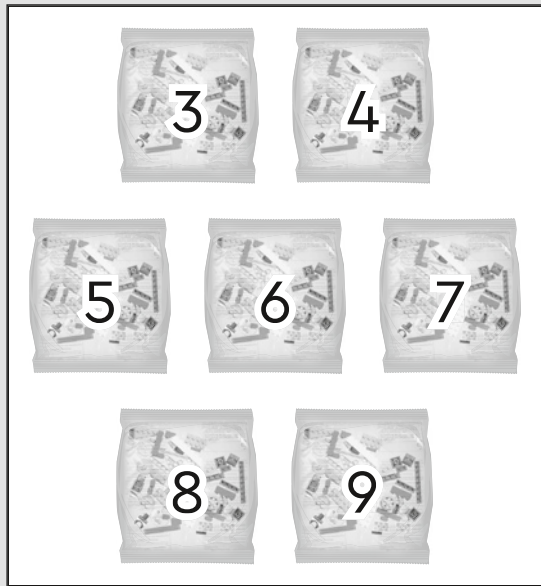
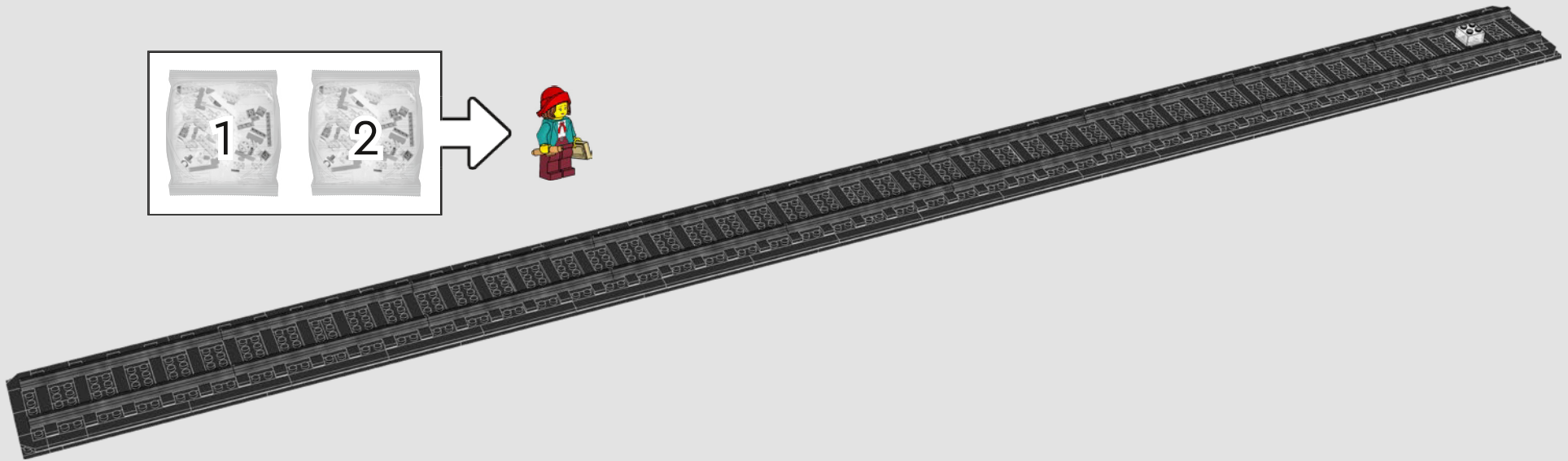
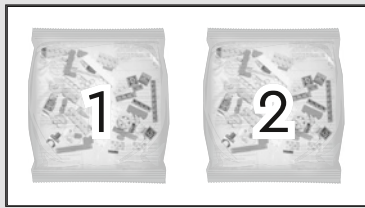

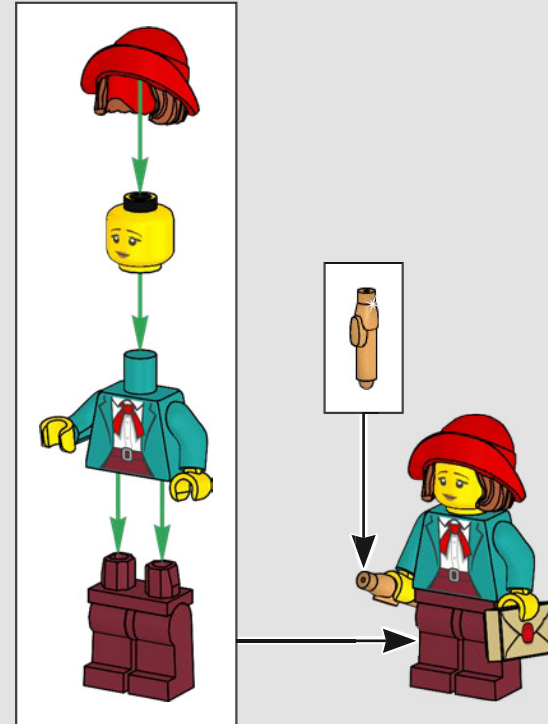
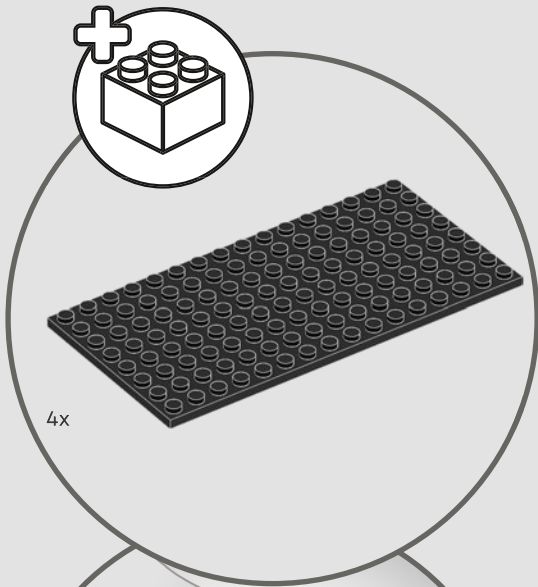

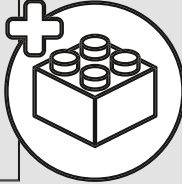
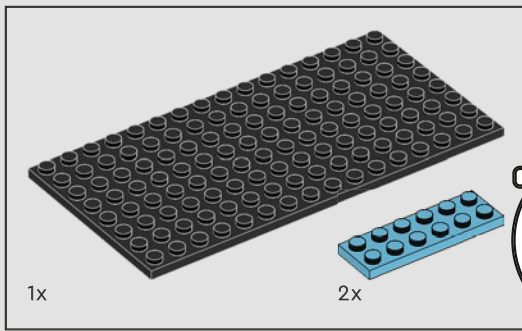

1

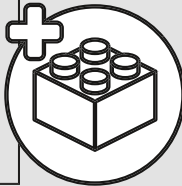
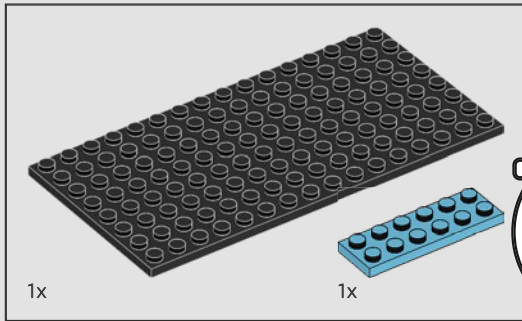
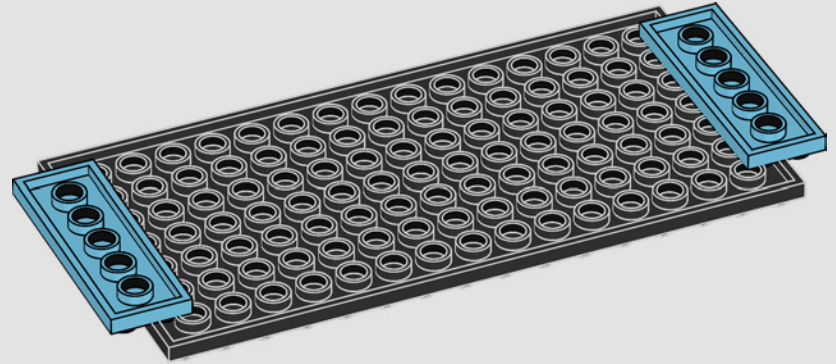

2

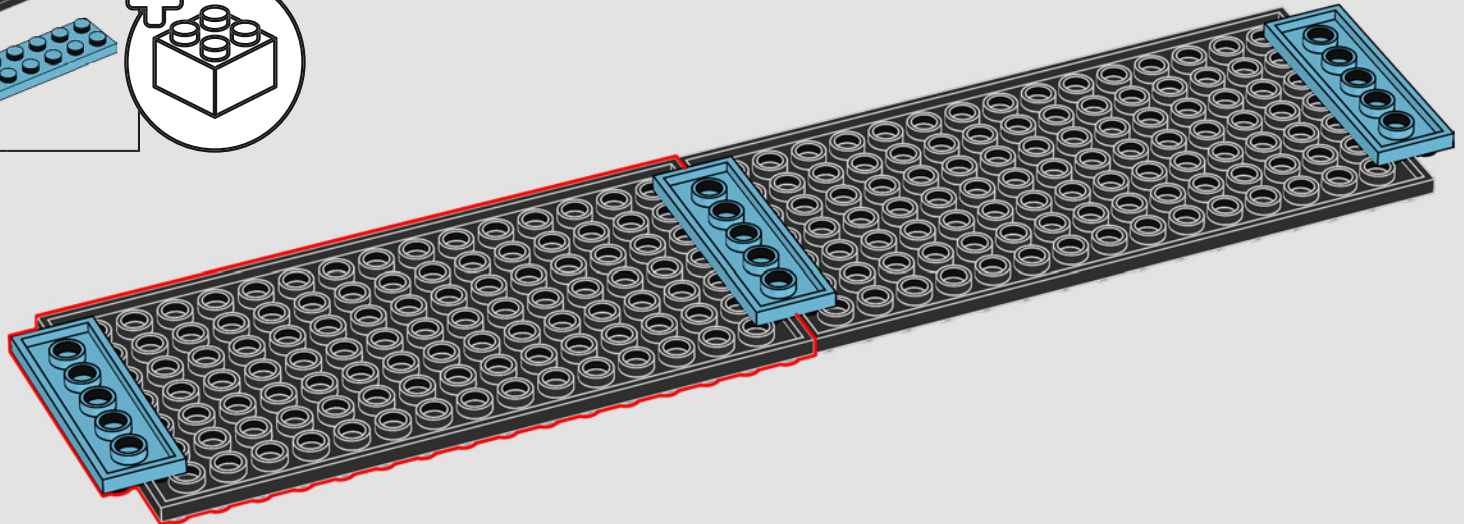

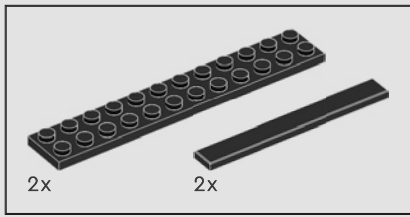

3

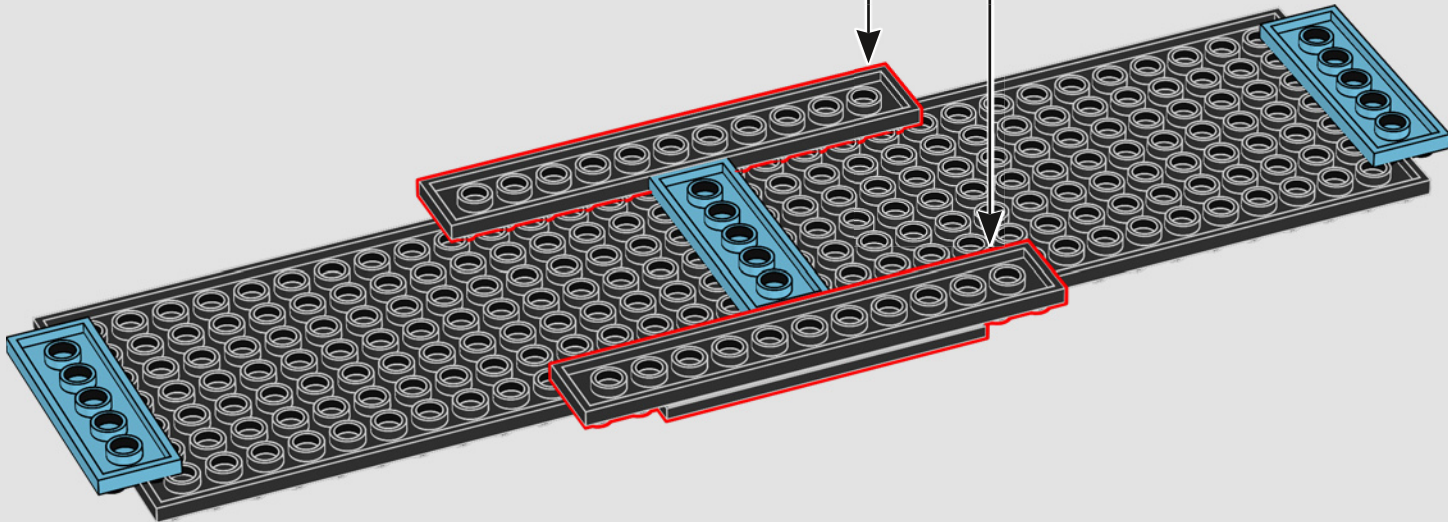
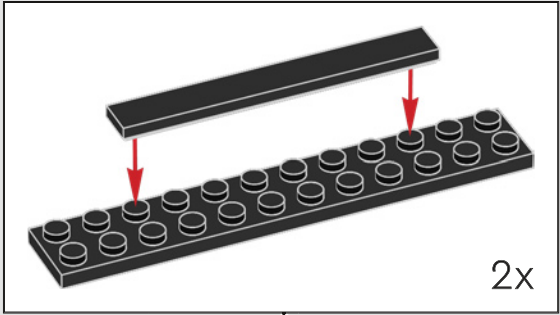

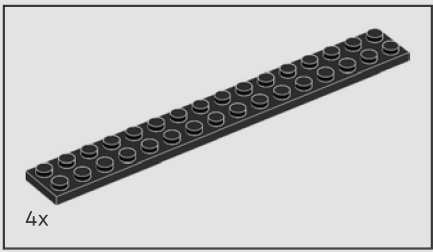

4

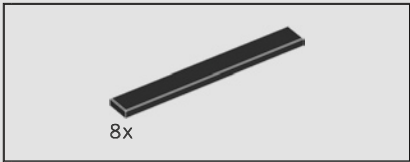
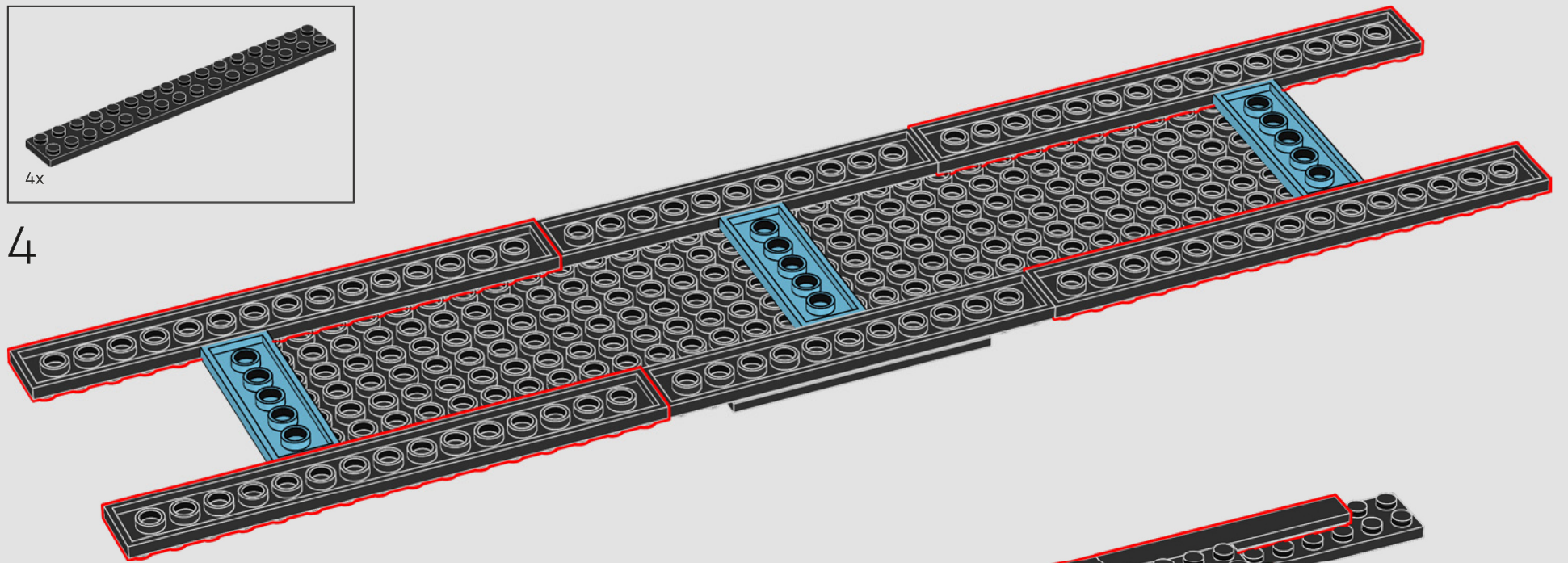

5

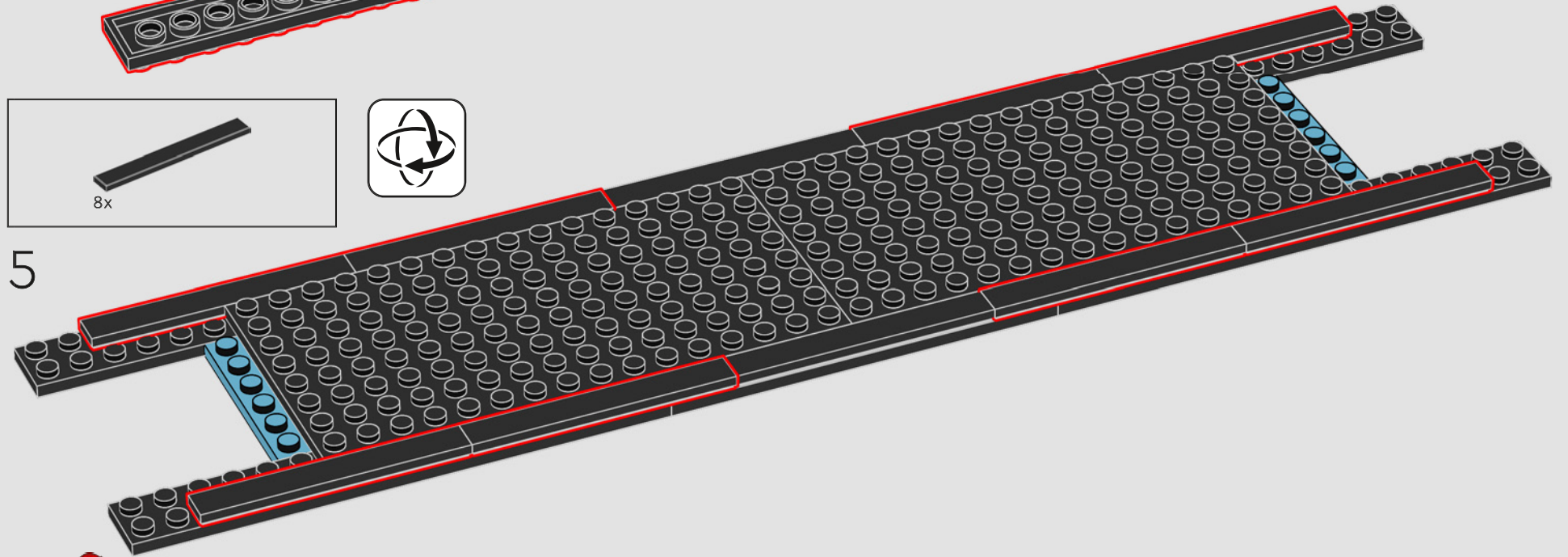

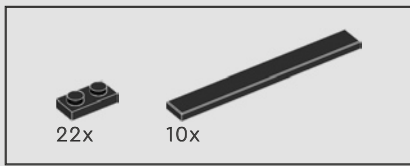

6

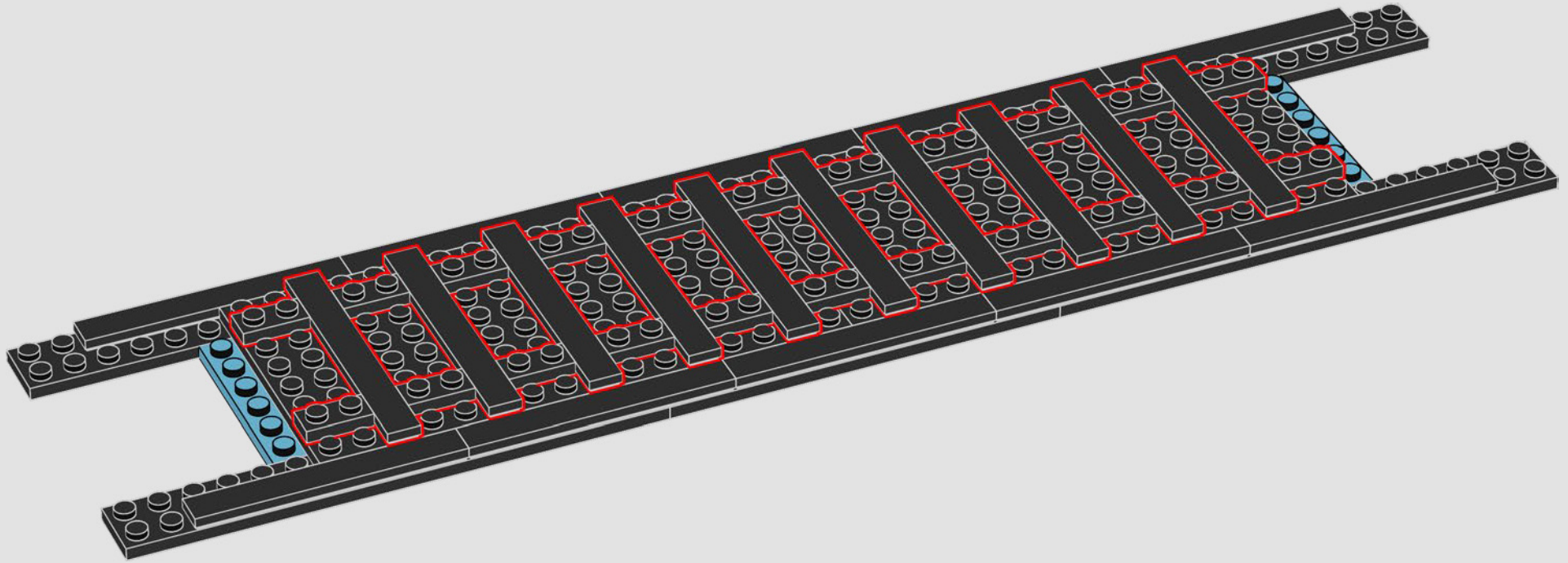

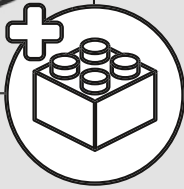
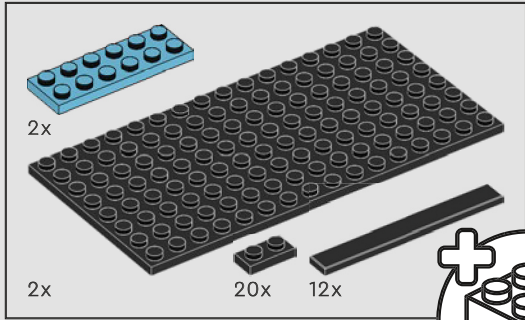
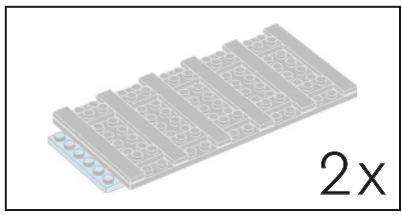

7

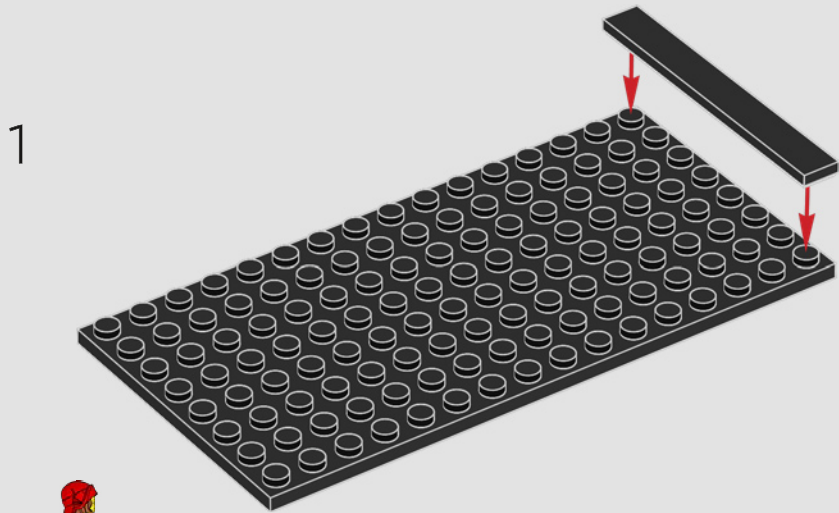

2

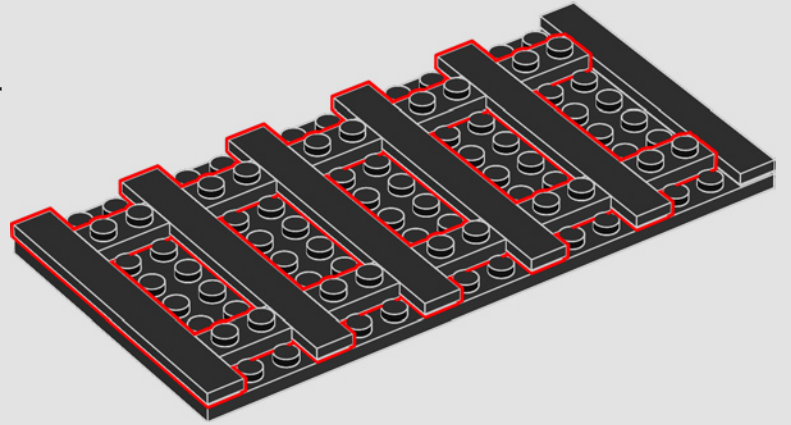

3

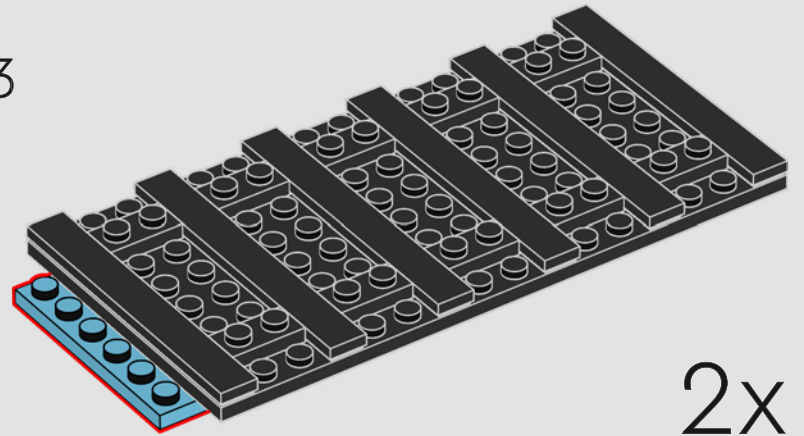

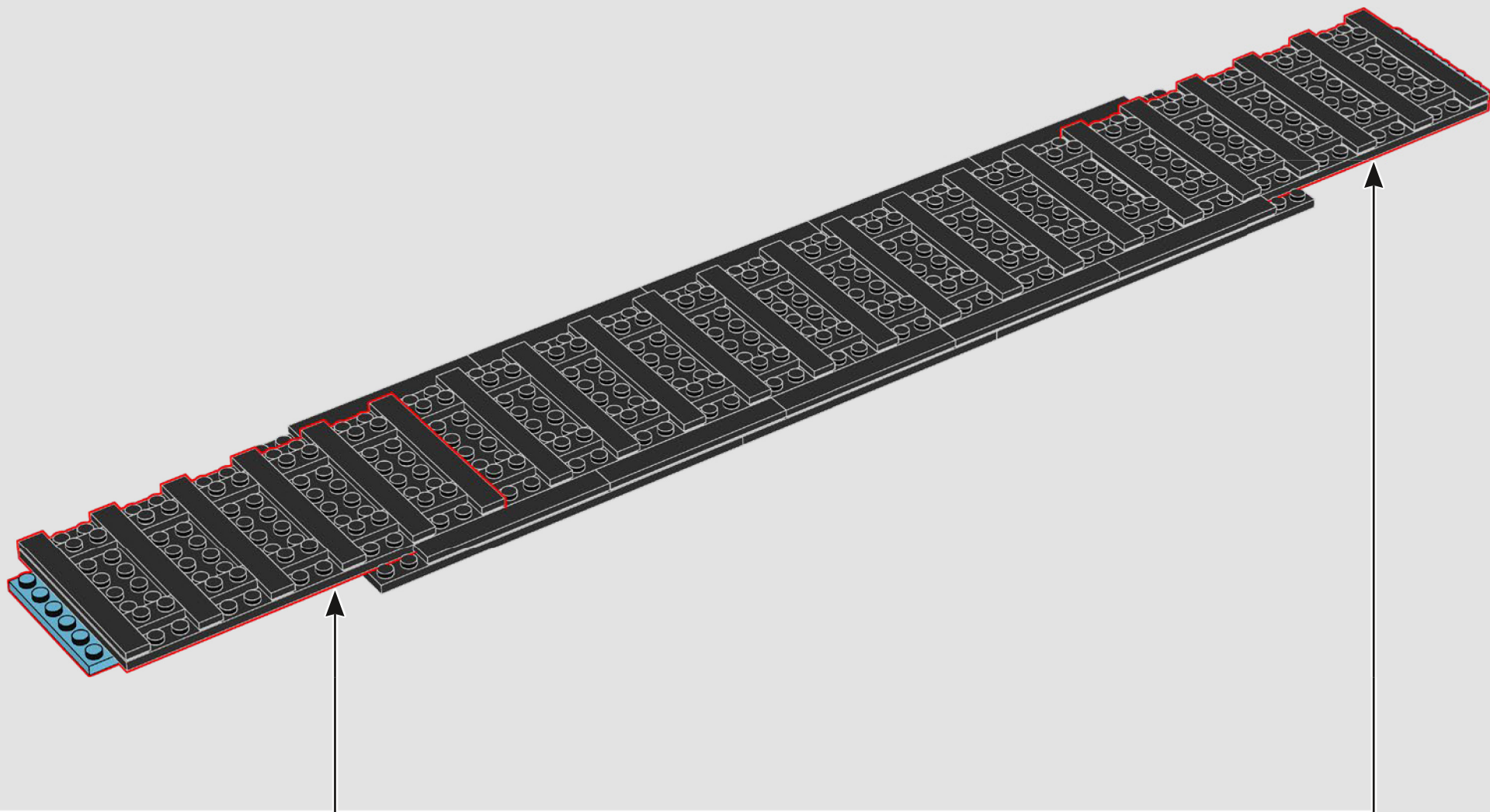

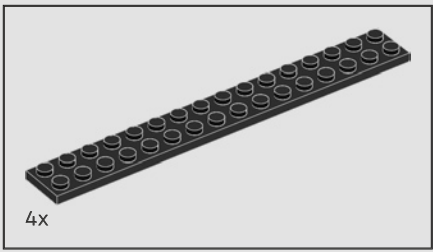

8

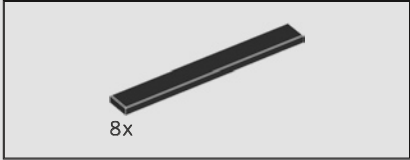
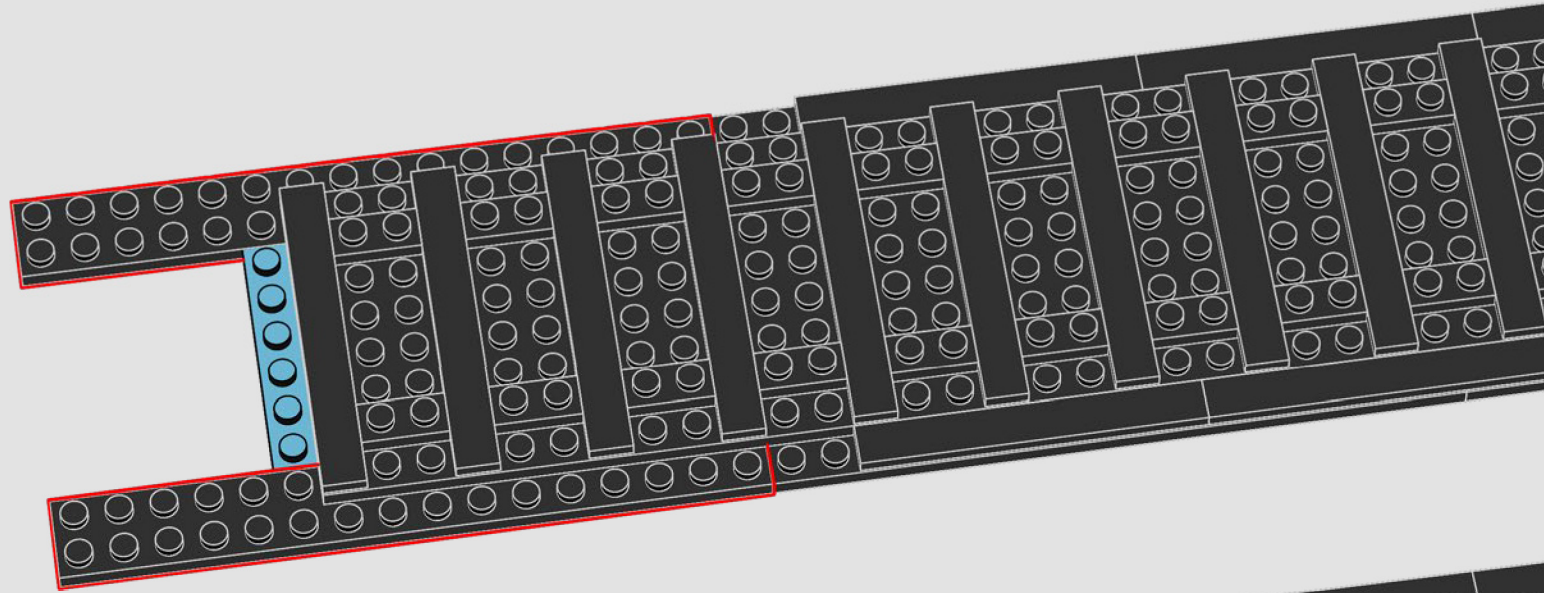

9

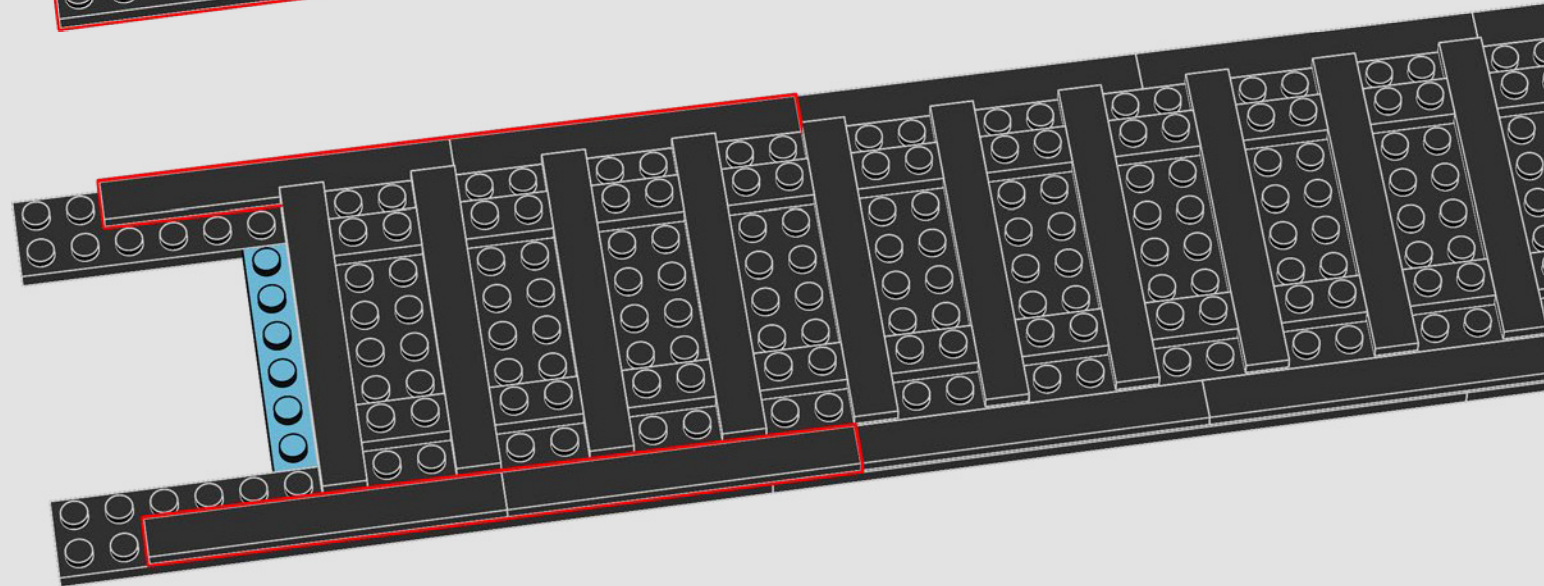

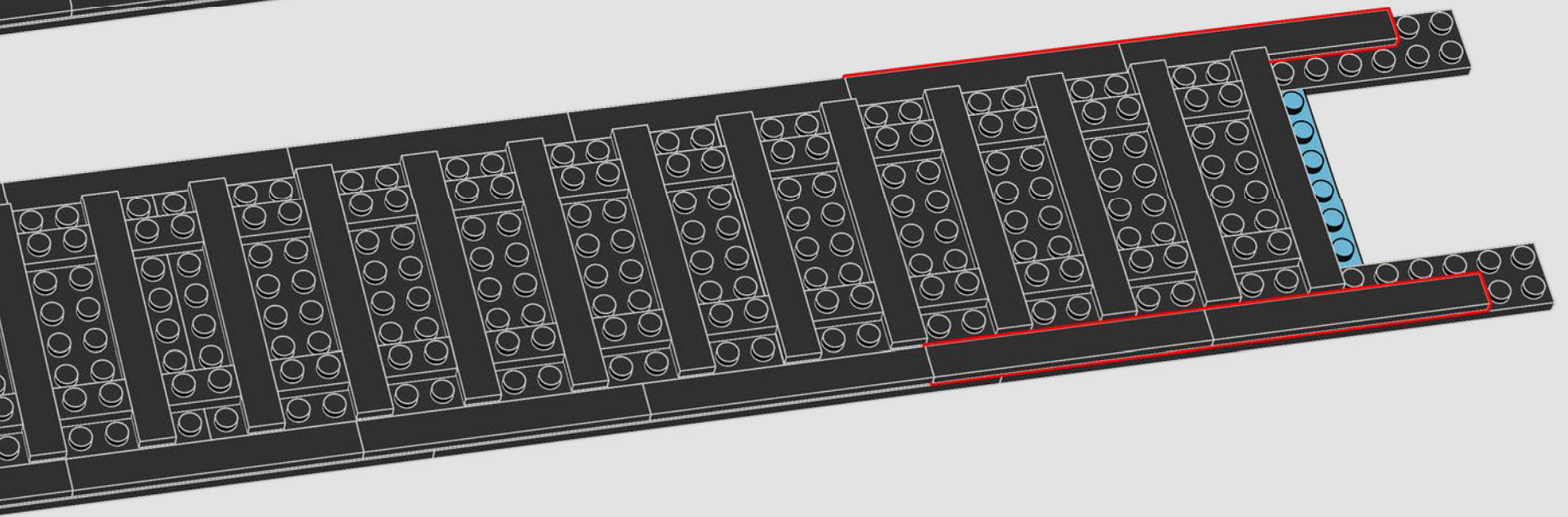
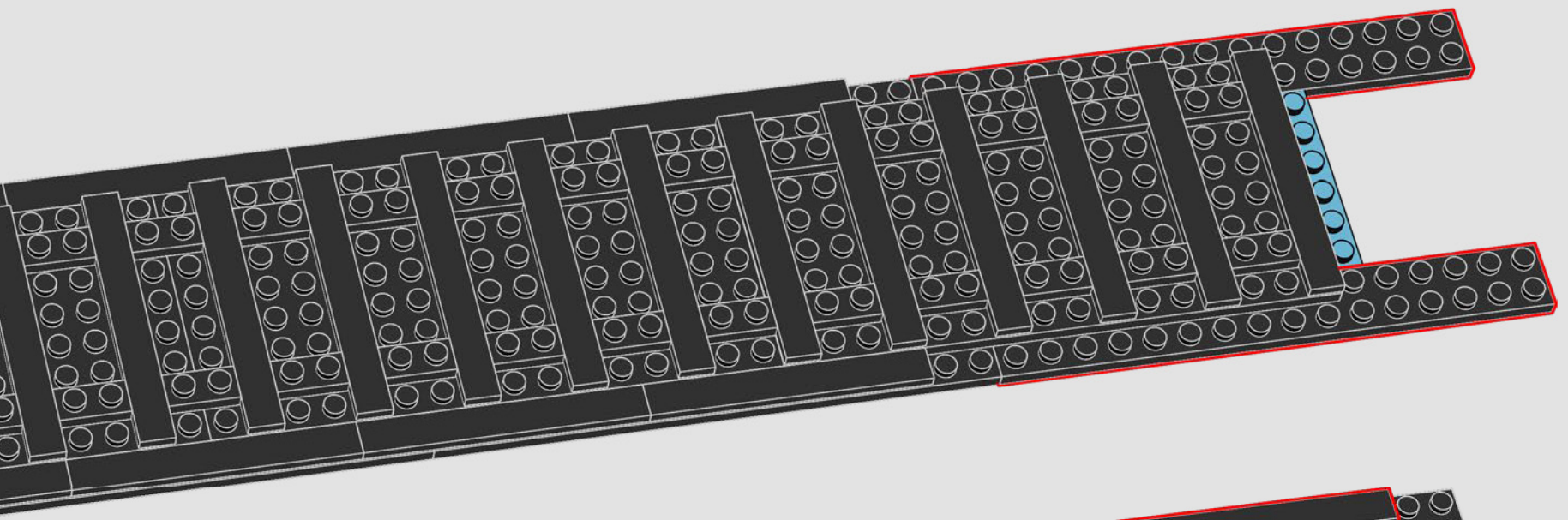

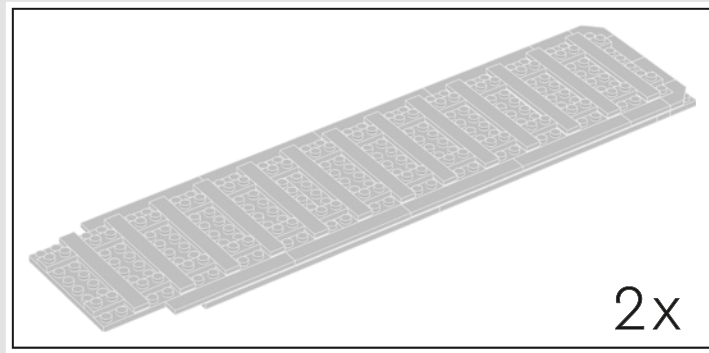
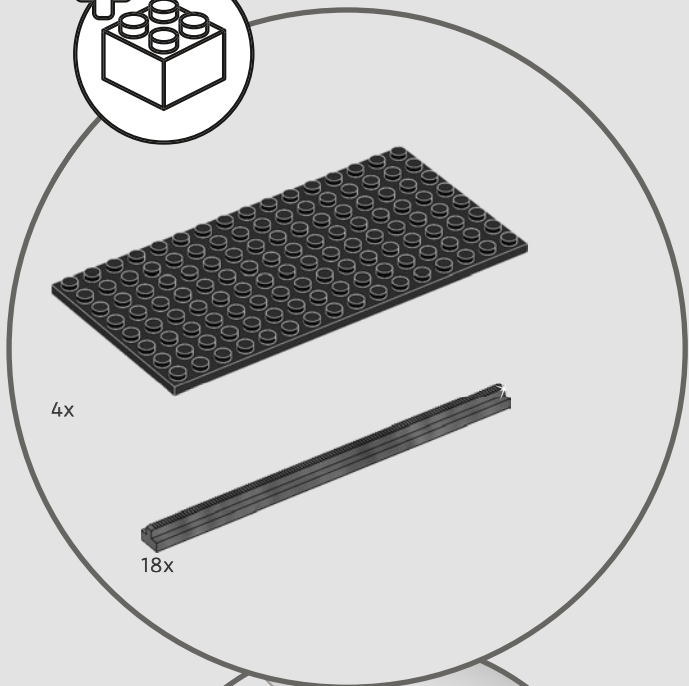
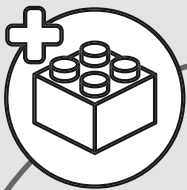

10

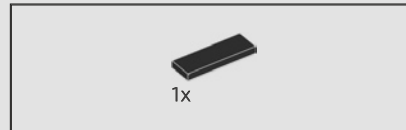
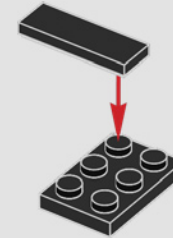

11

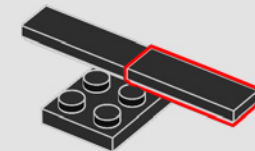

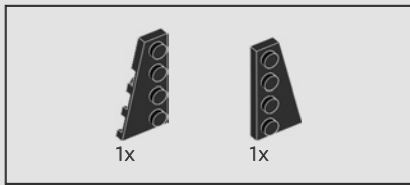

12

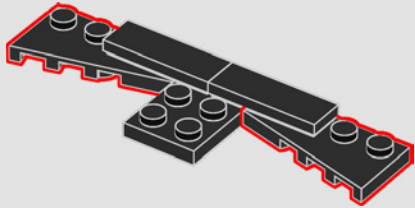

13

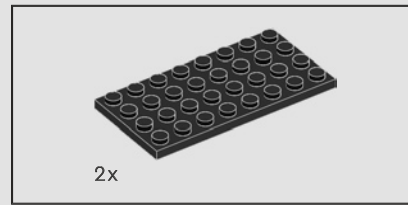
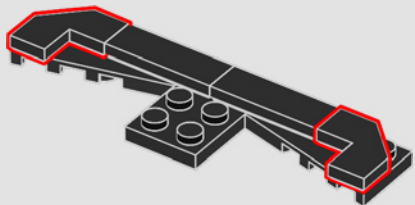

14

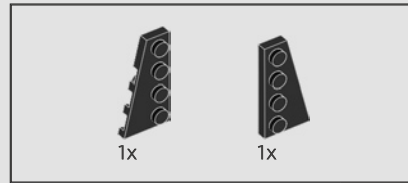
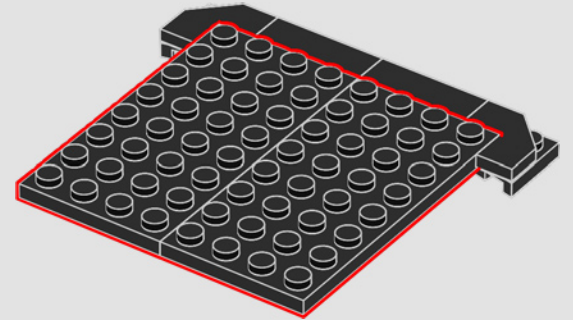

15

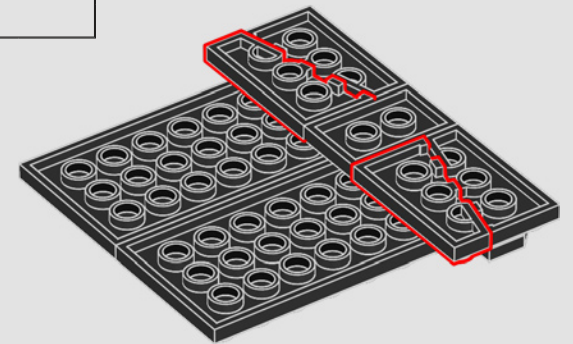

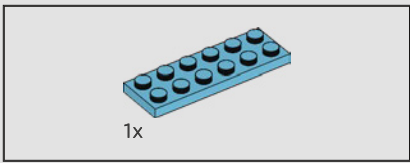

16

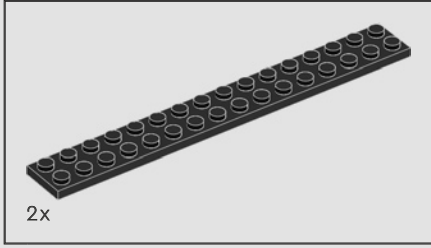
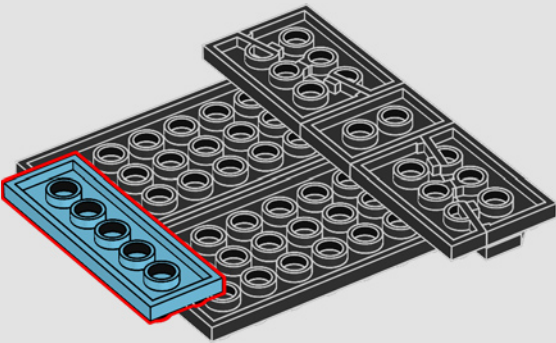

17

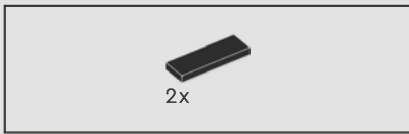
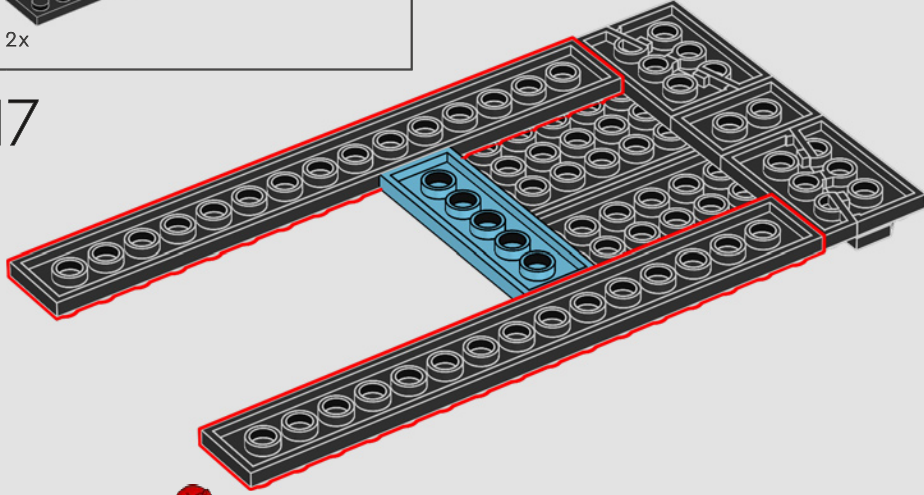

18

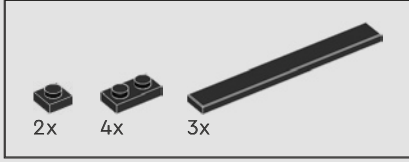
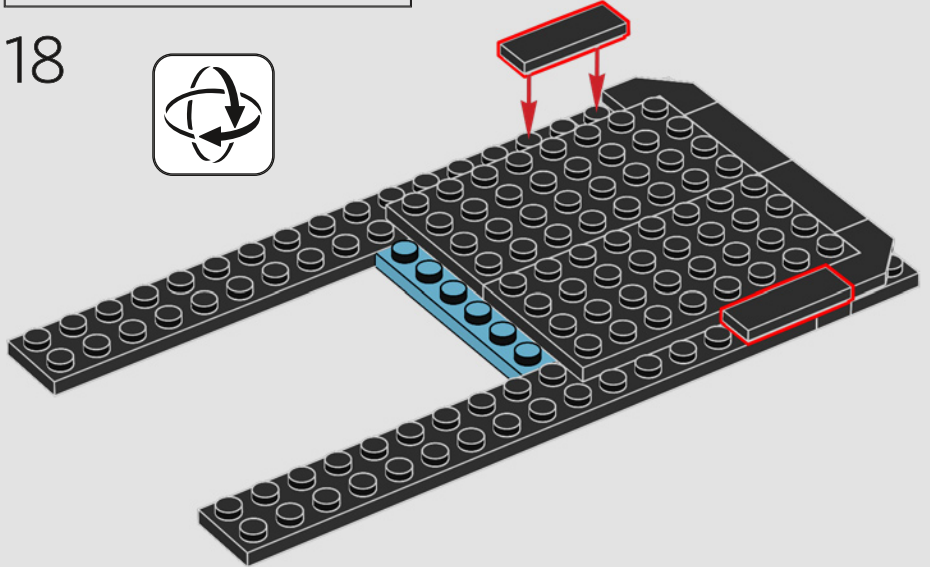

19

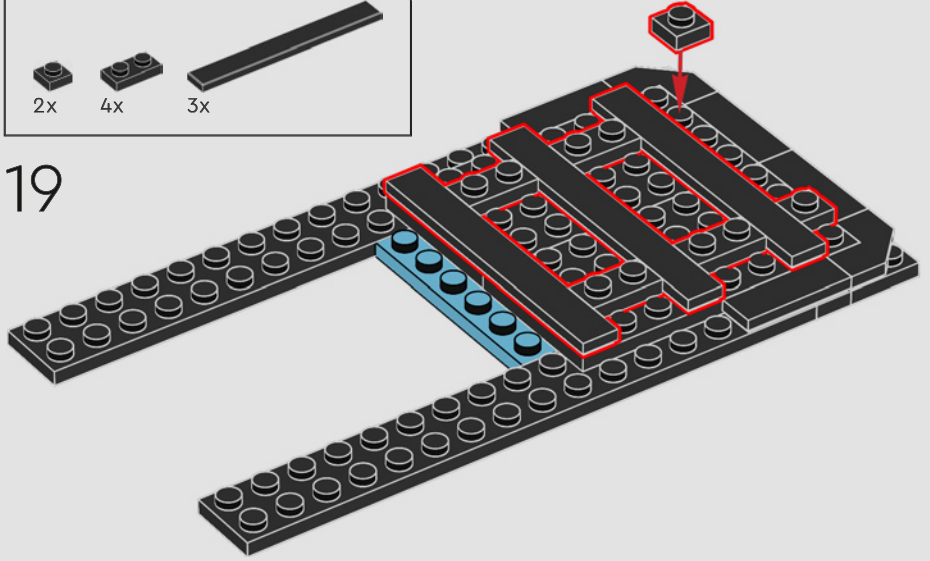

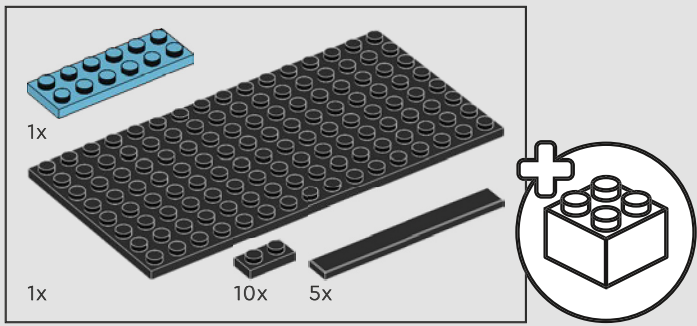

20

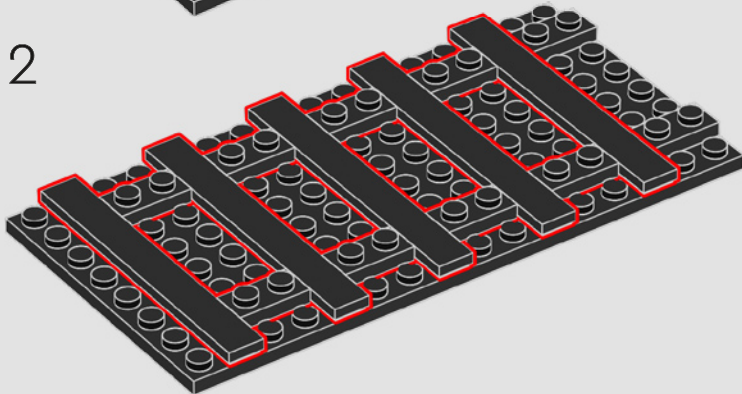
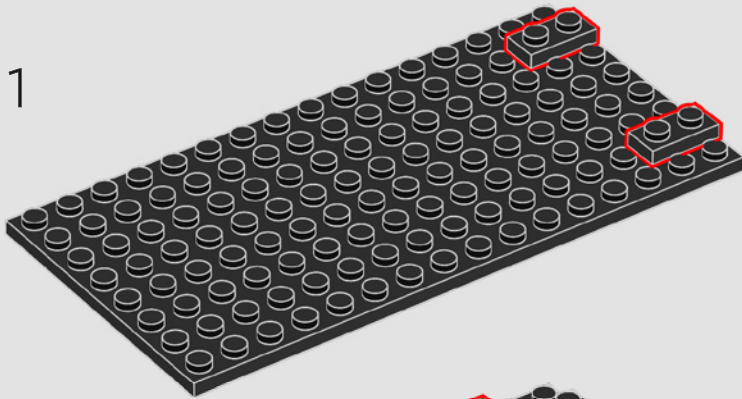

3

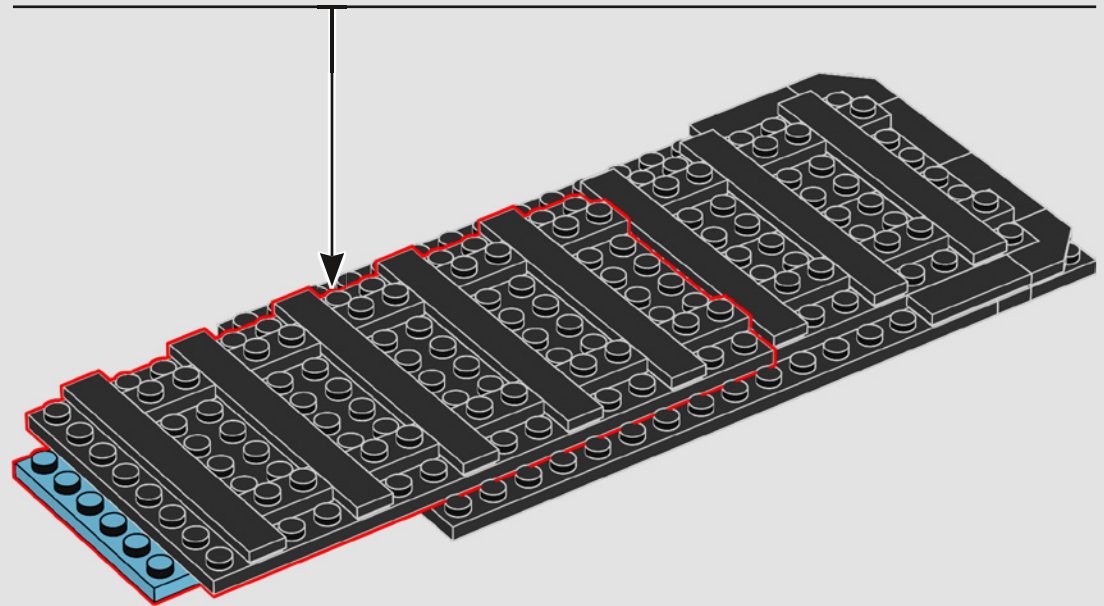
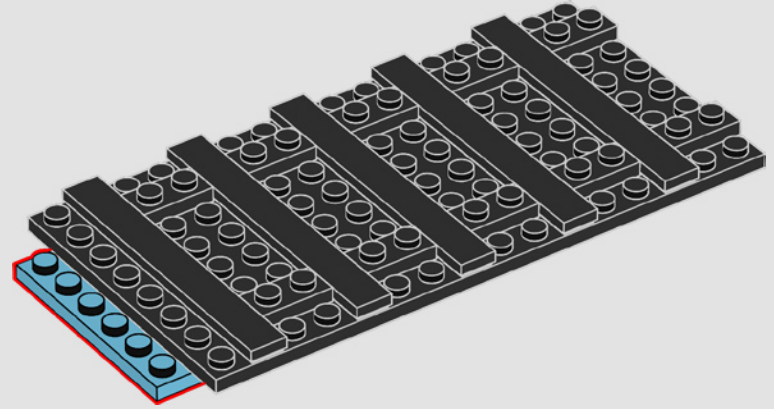

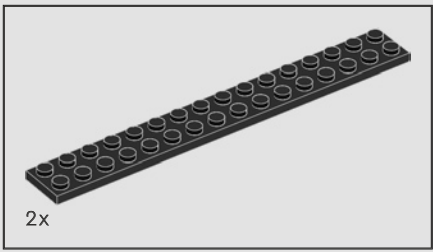

21

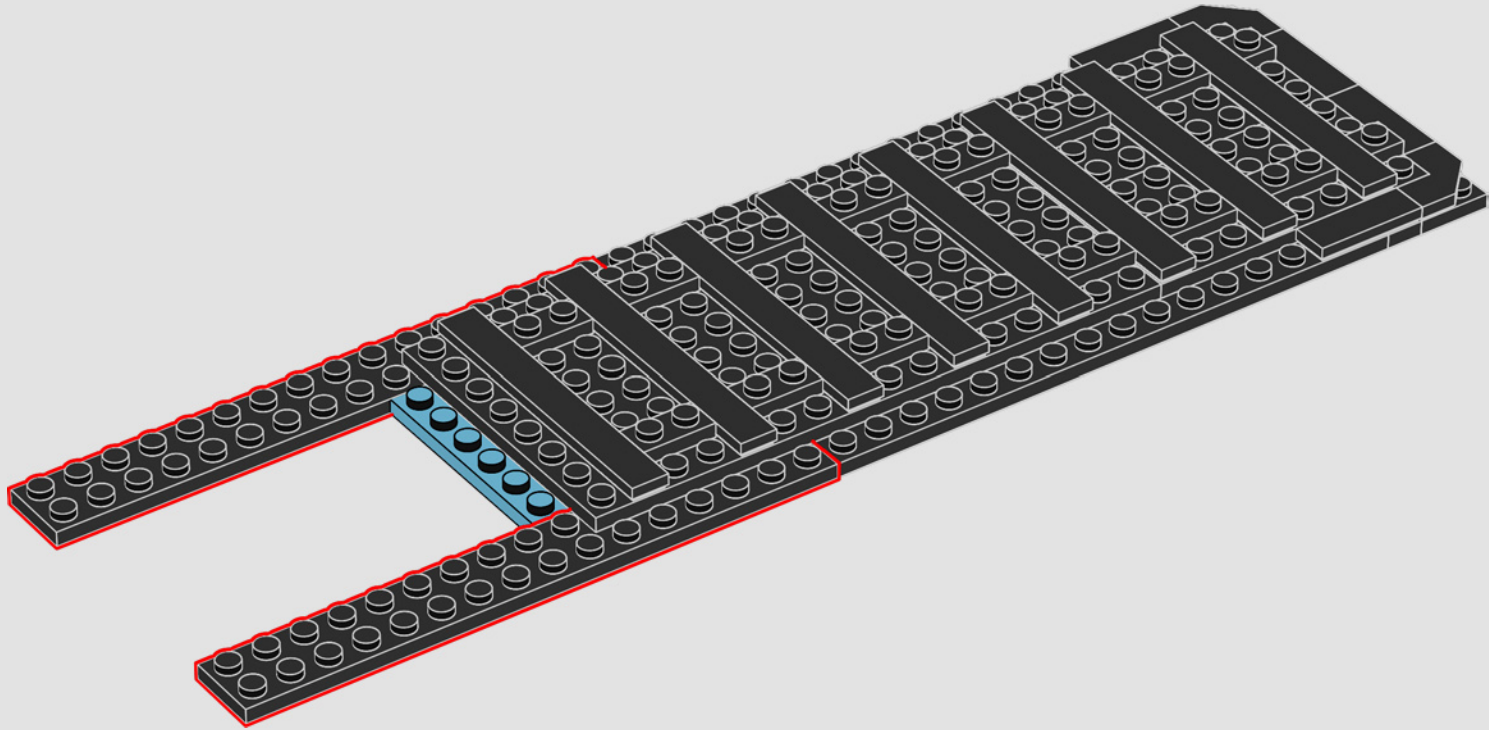

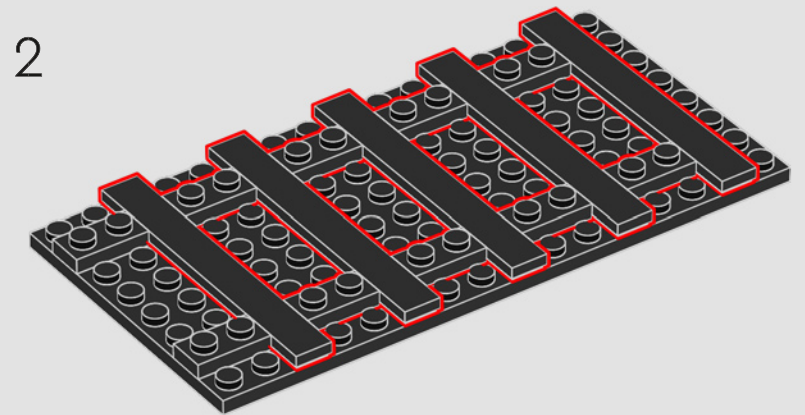
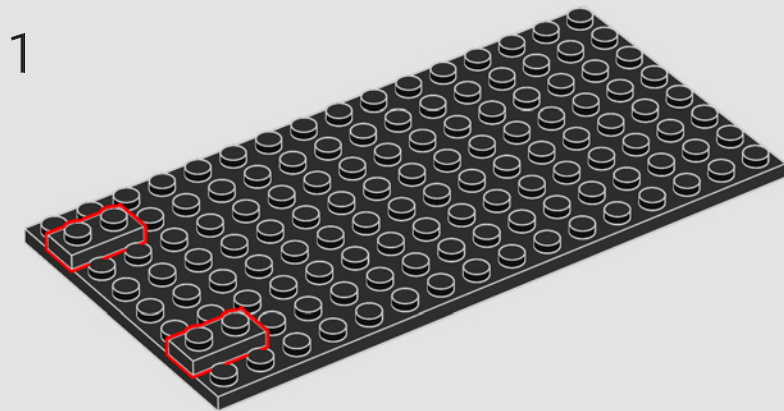
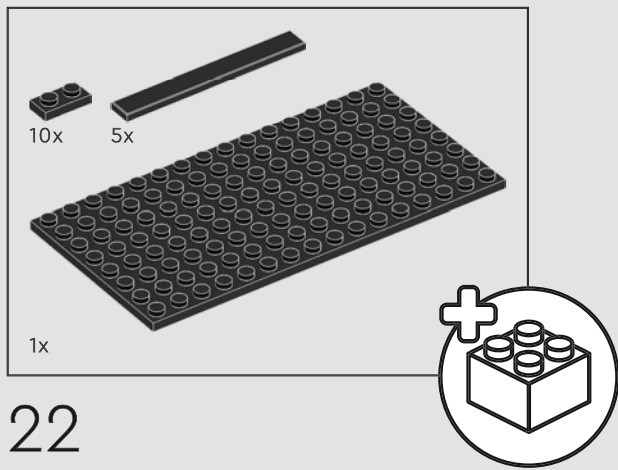

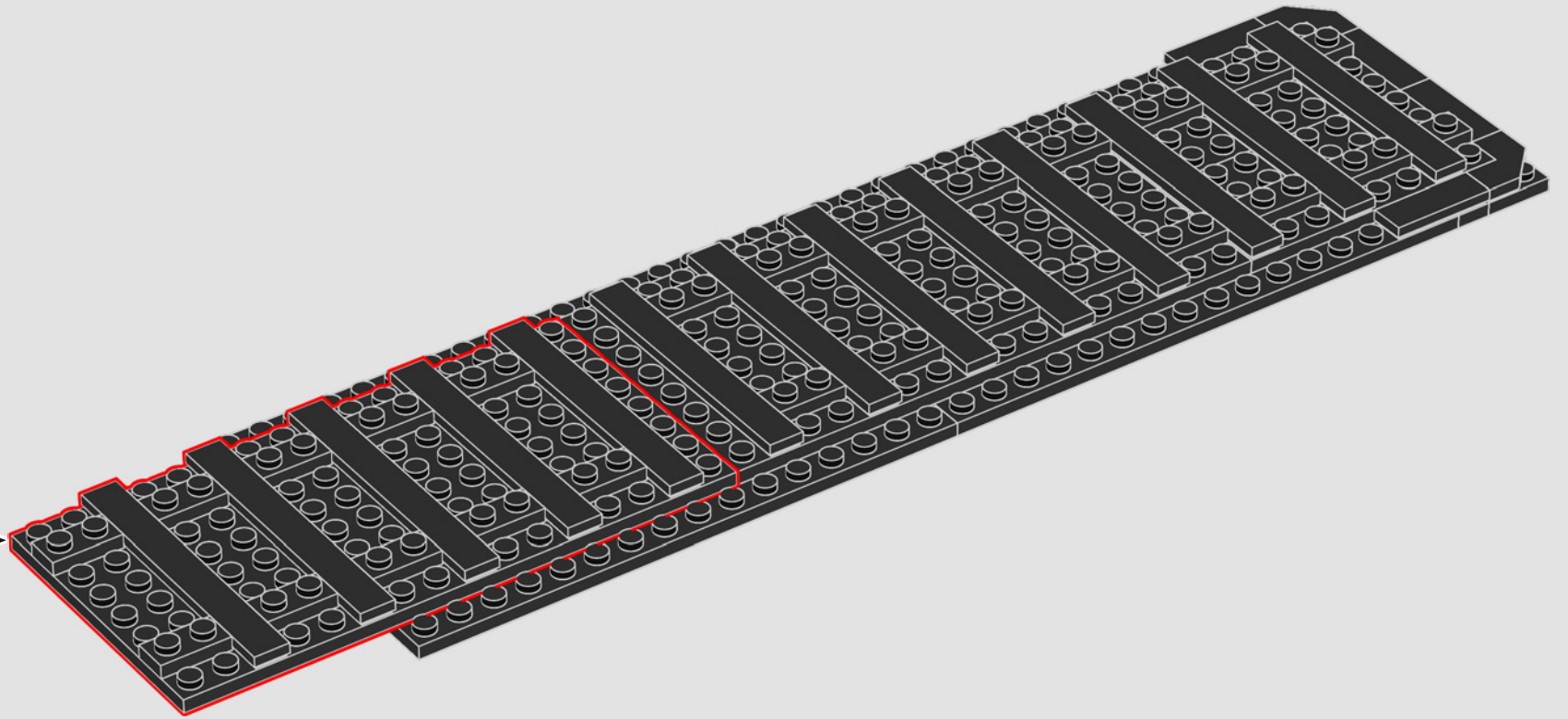

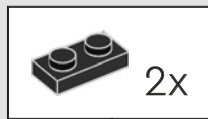

23

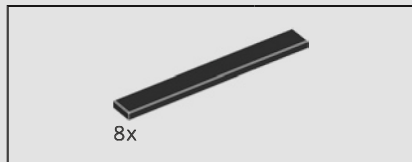
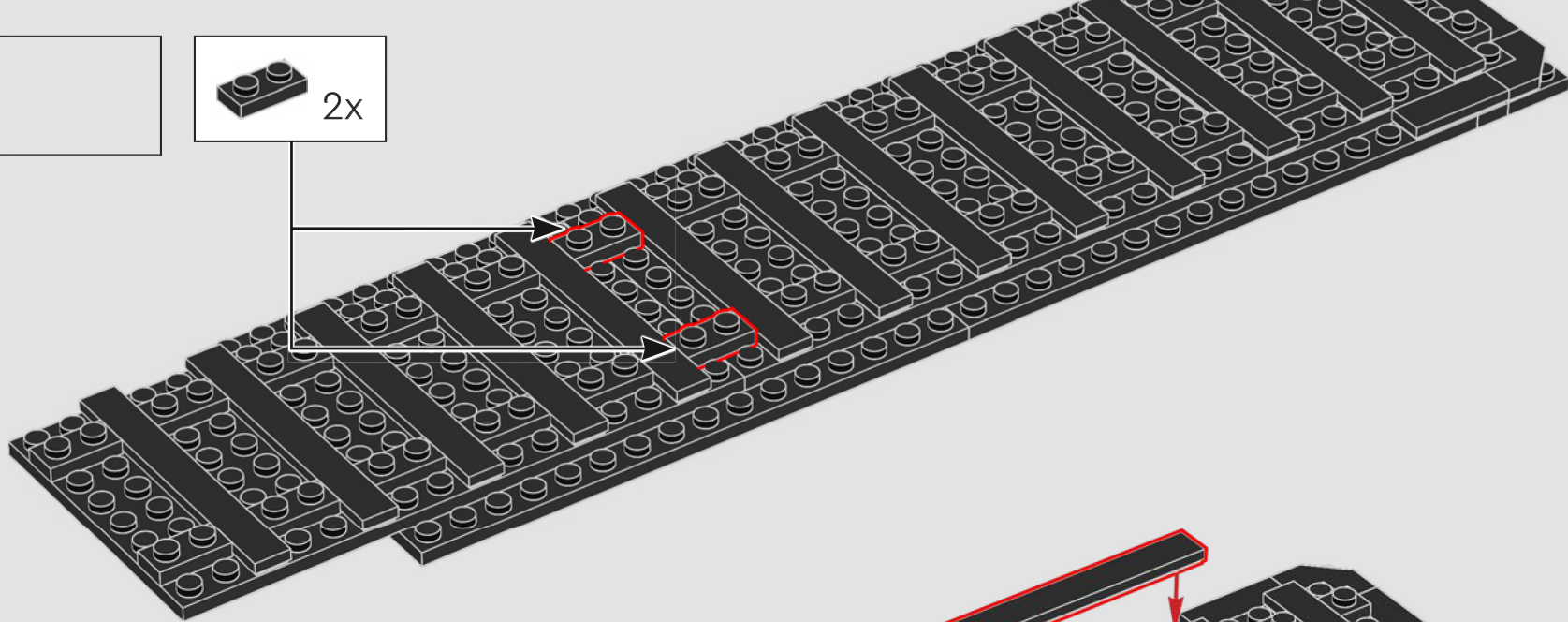

24

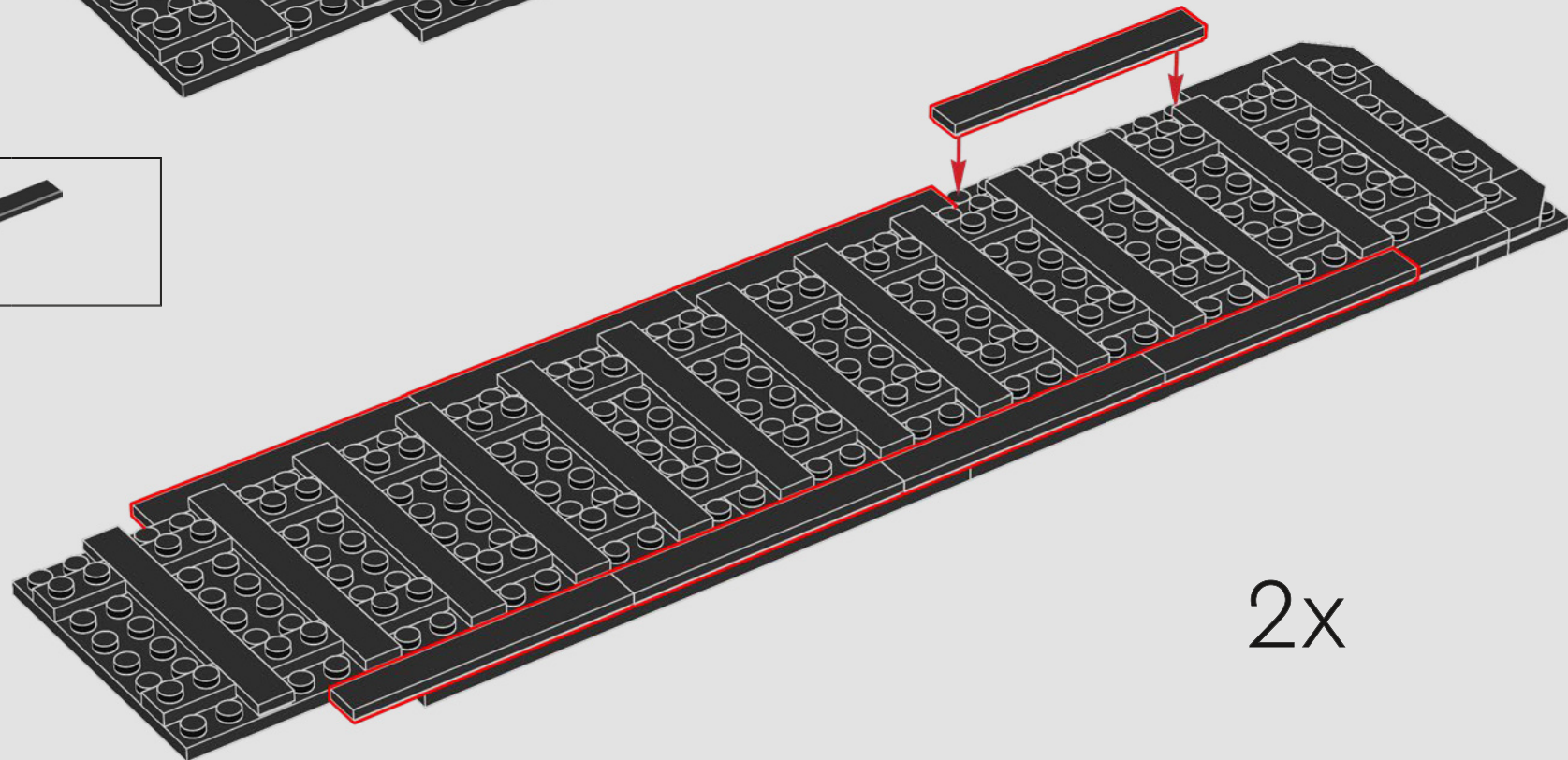

2x



2x

25

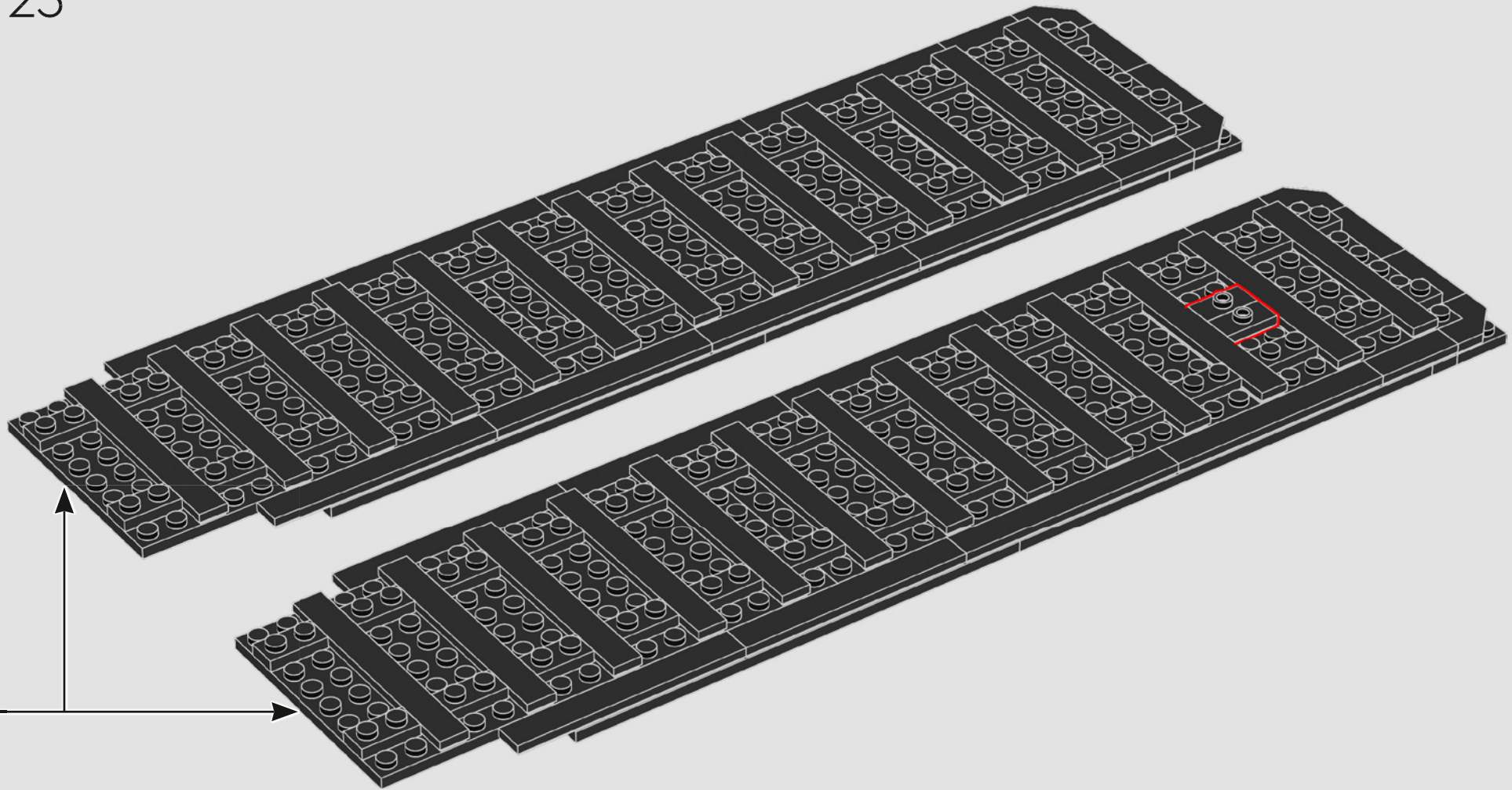

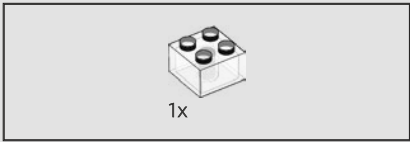

26

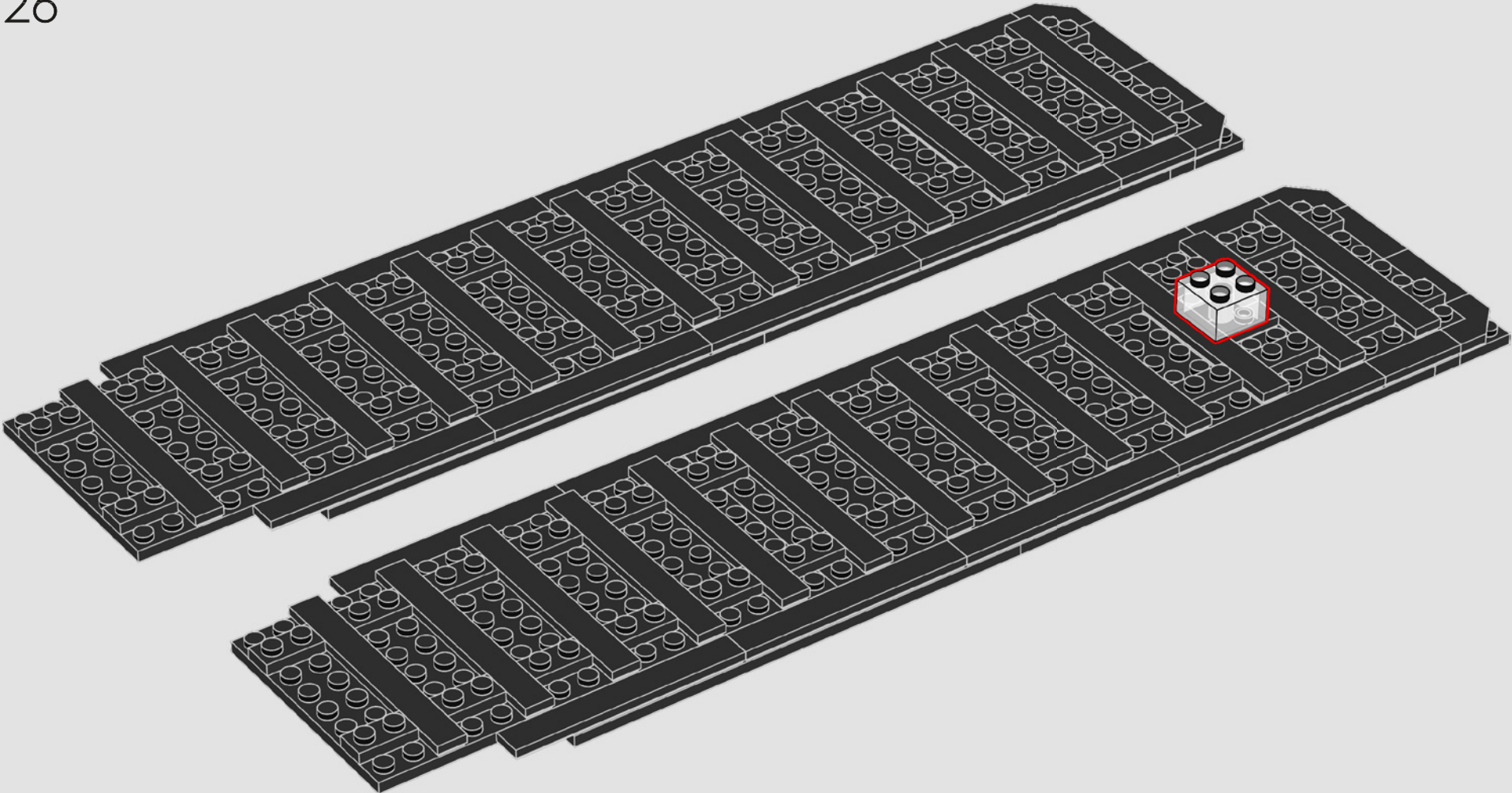

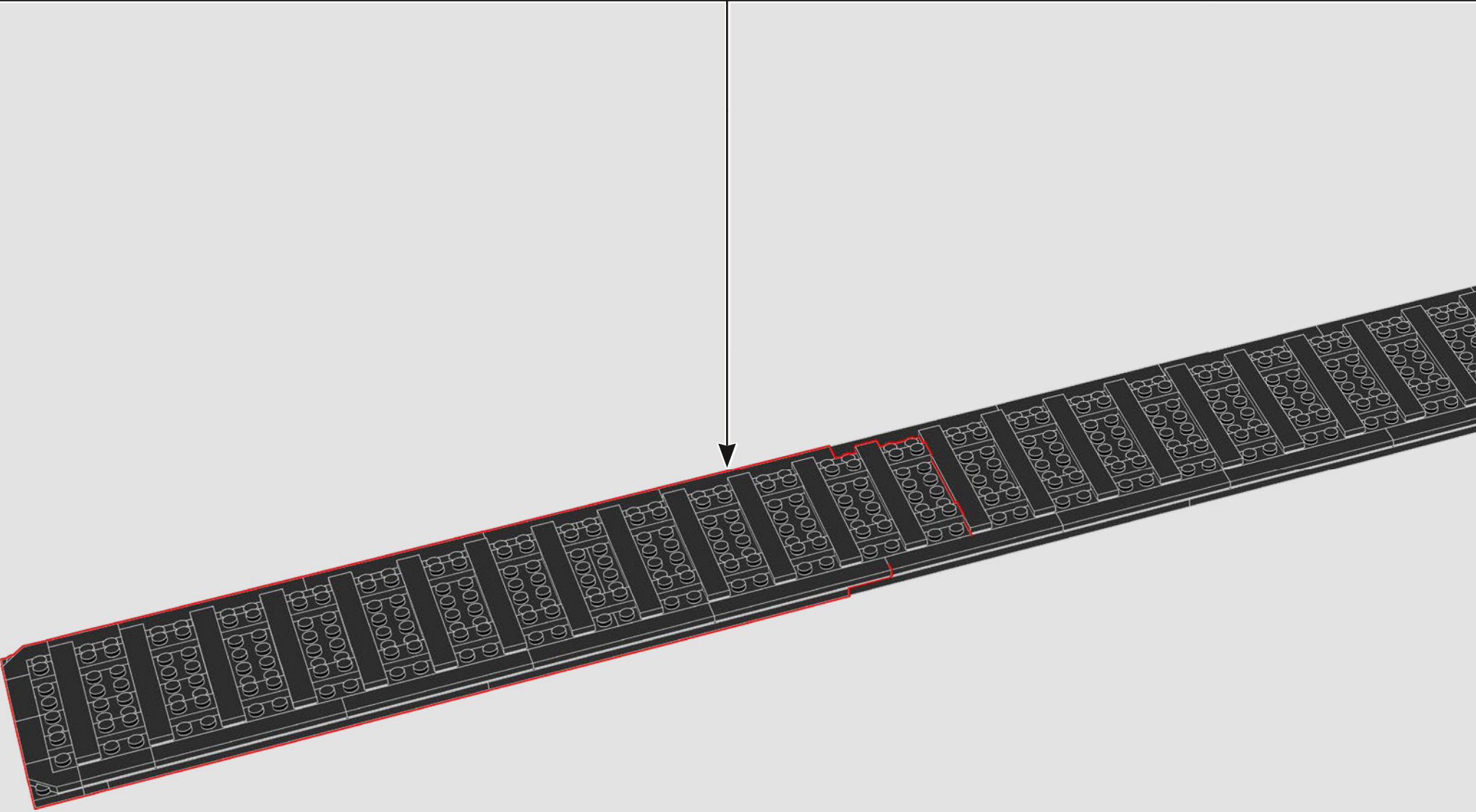

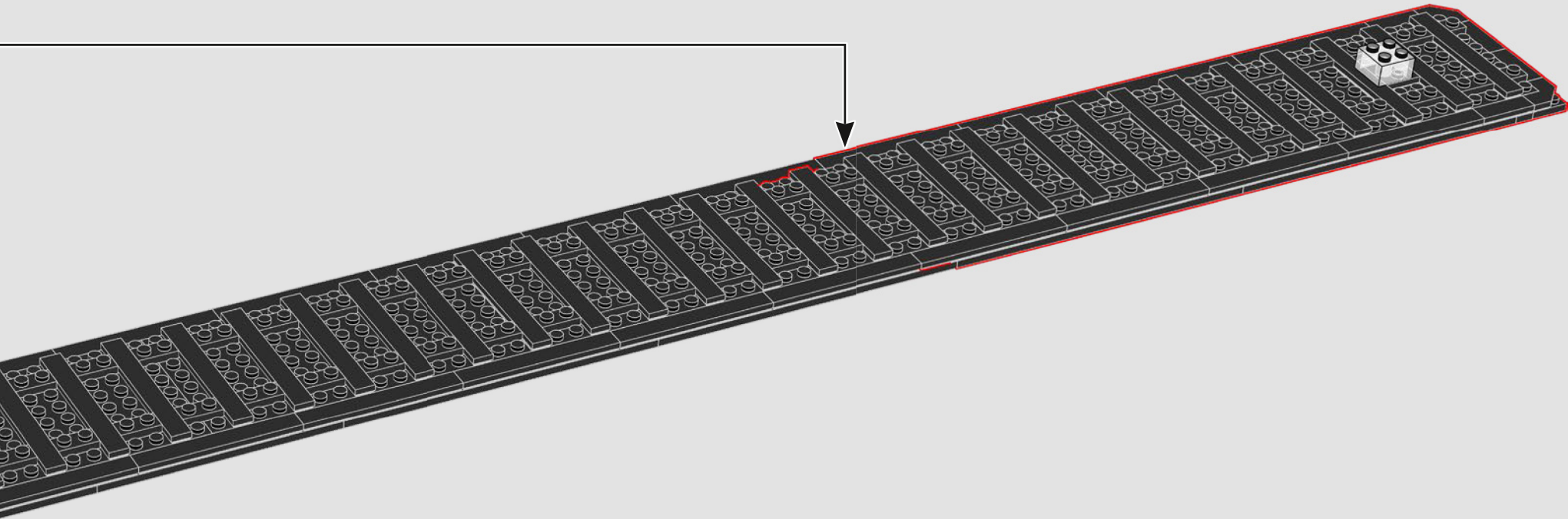

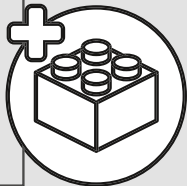
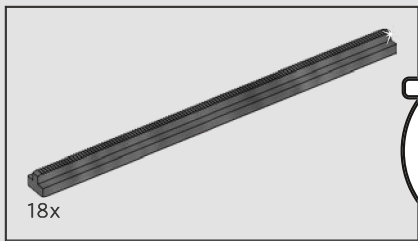

28

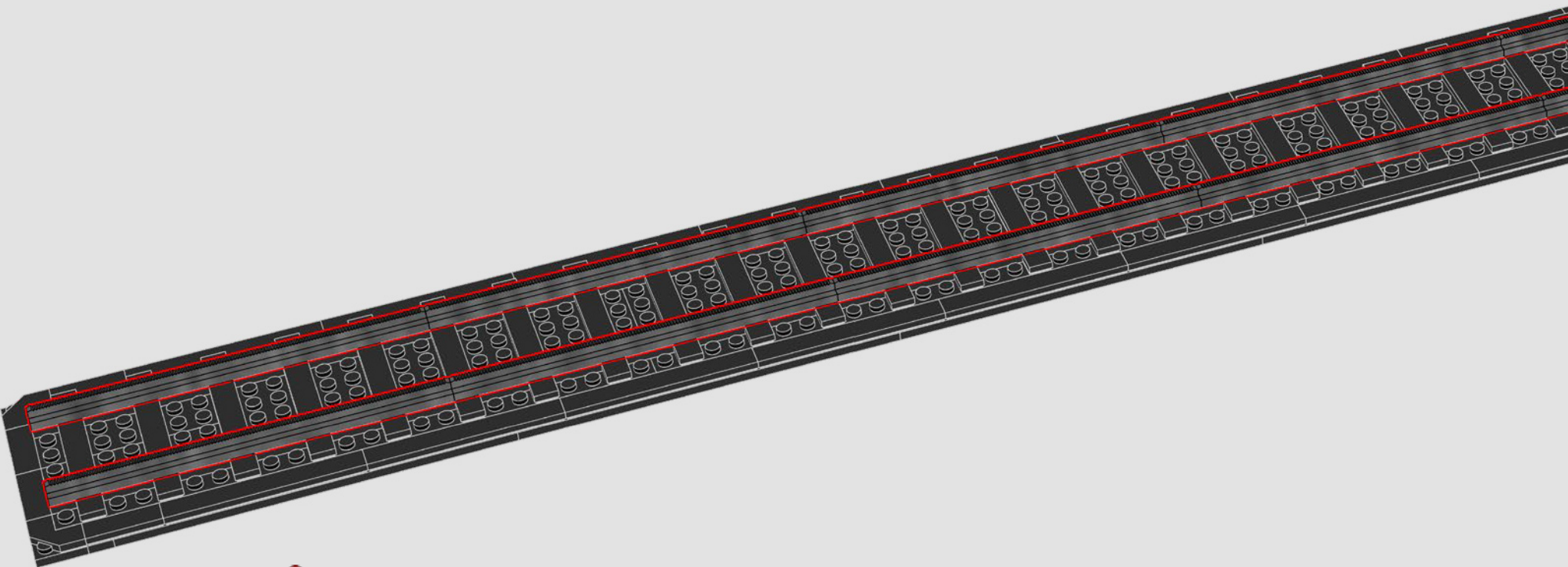

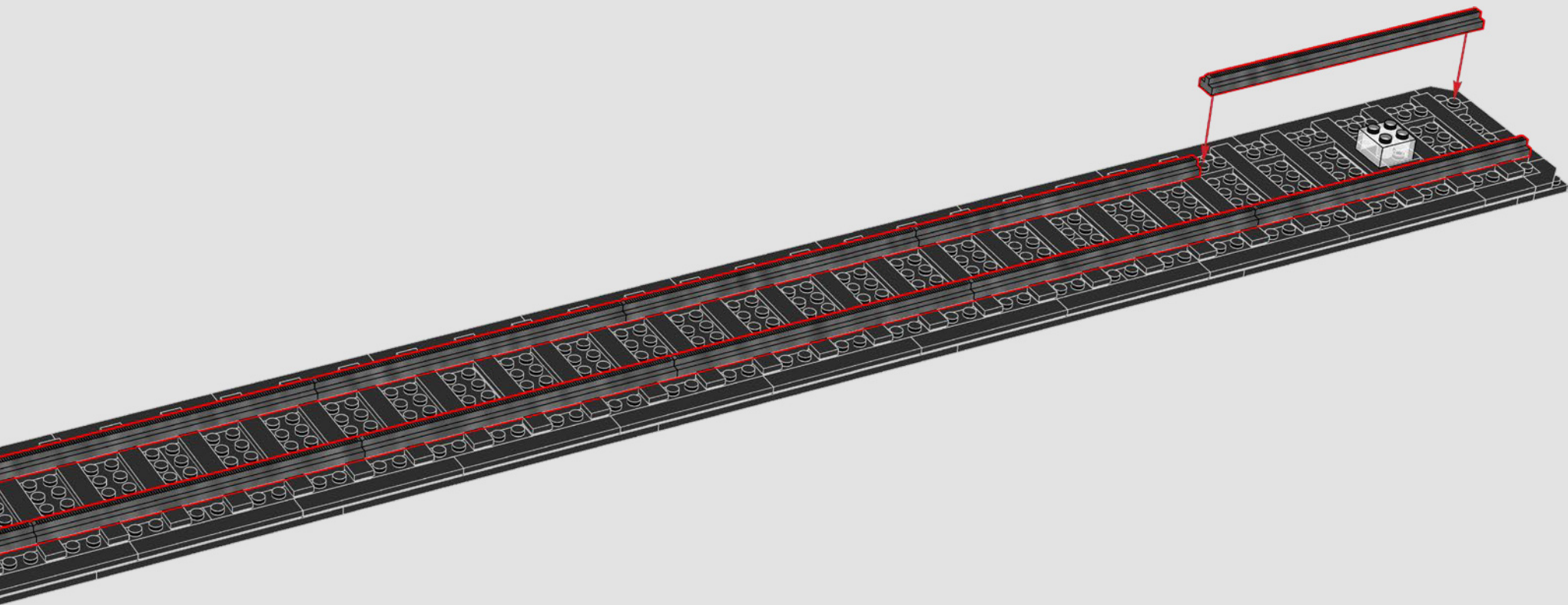

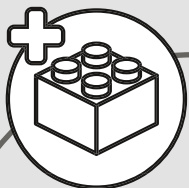

启程：巴黎
“我们的旅程从巴黎东站 (Gare de l'Est Station) 开始，乘客们急切地等待着火车的到来。”

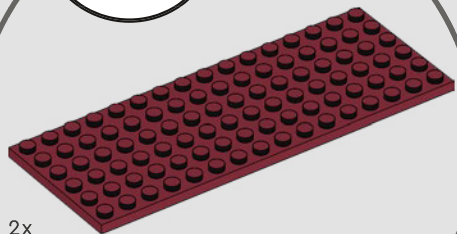

2x

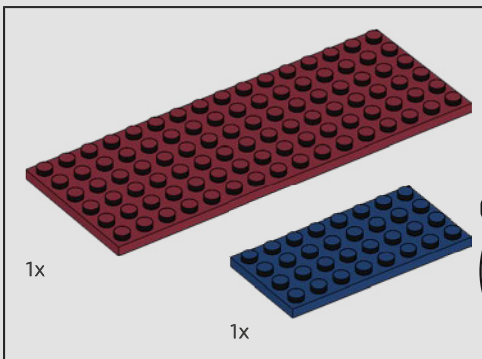
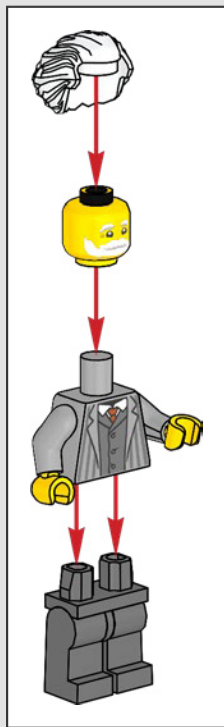
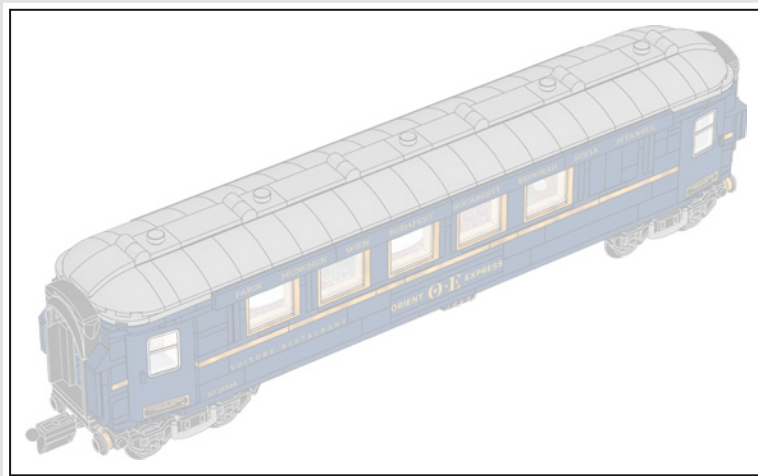

1x

1x

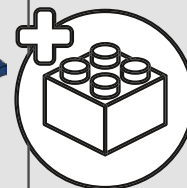

29

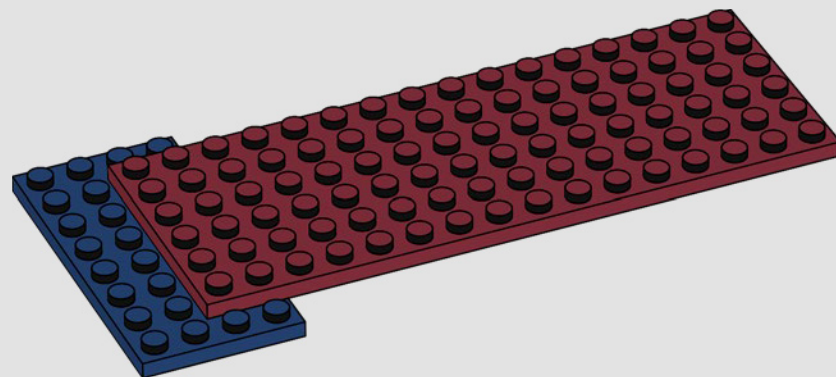

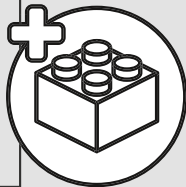
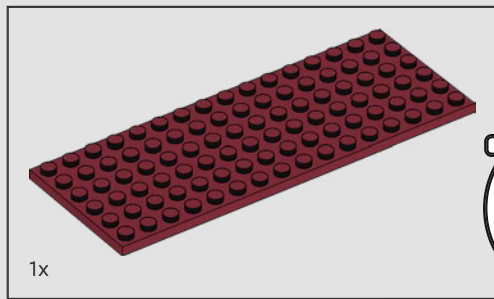

30

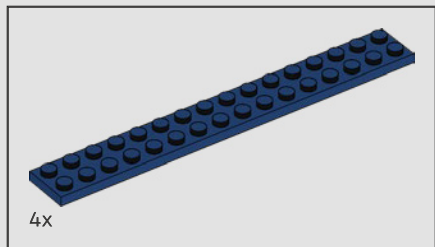
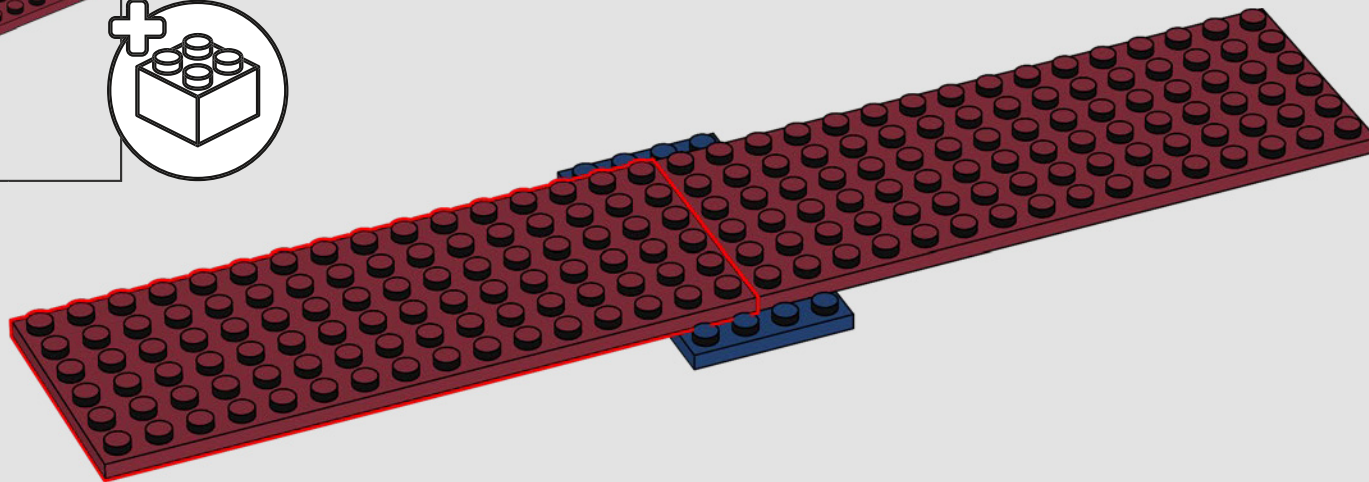

31

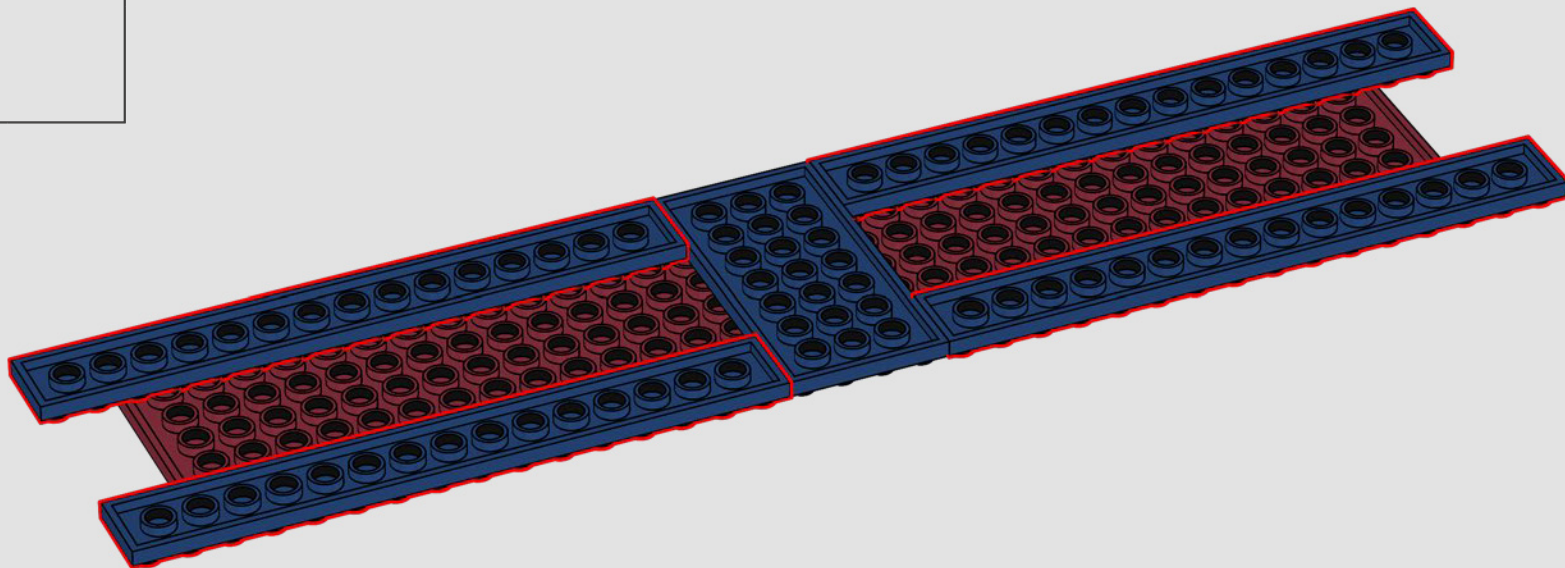

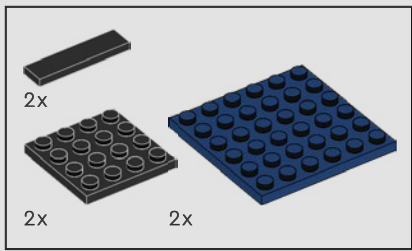

32

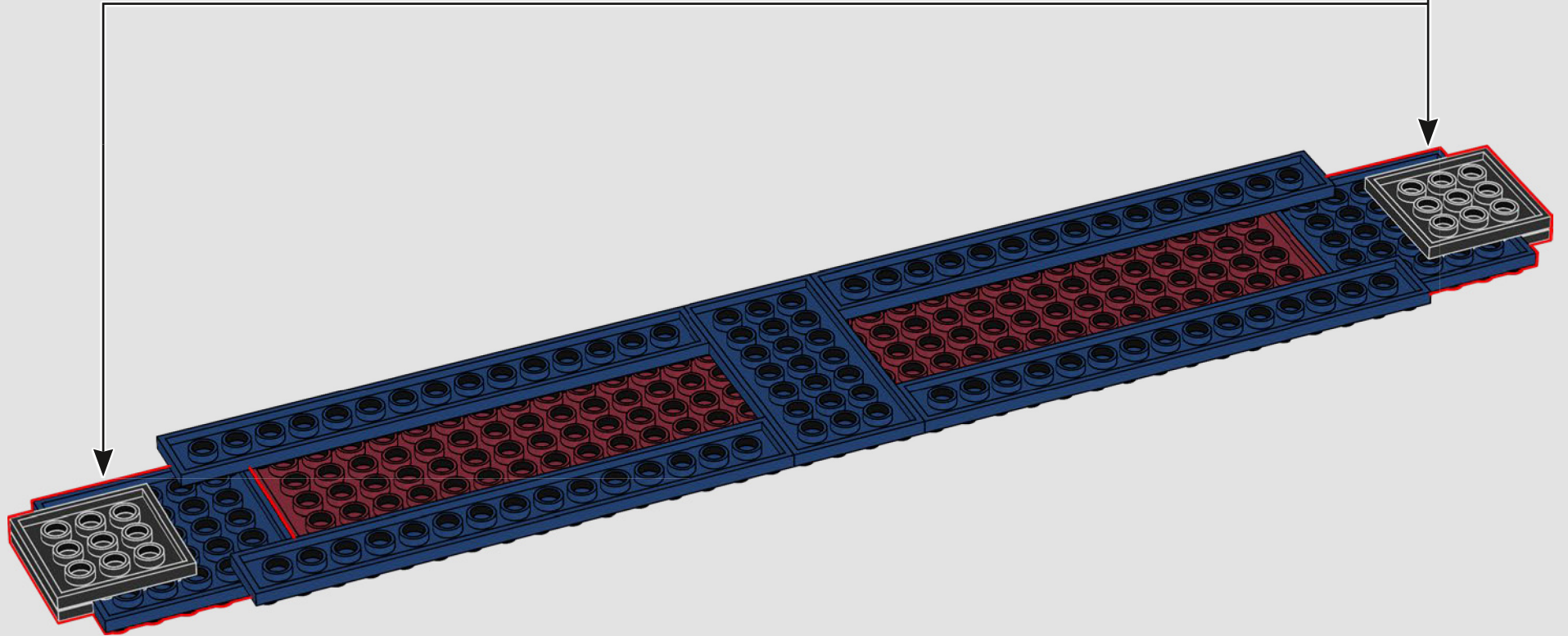
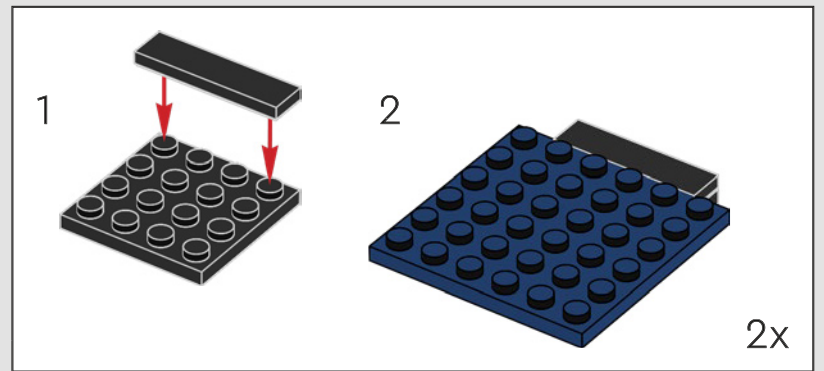

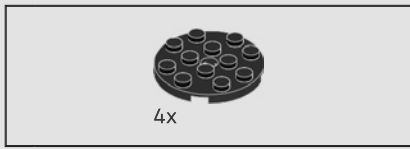

33

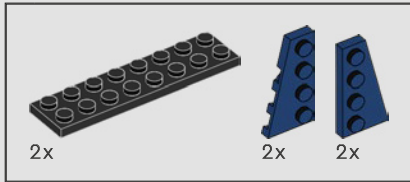
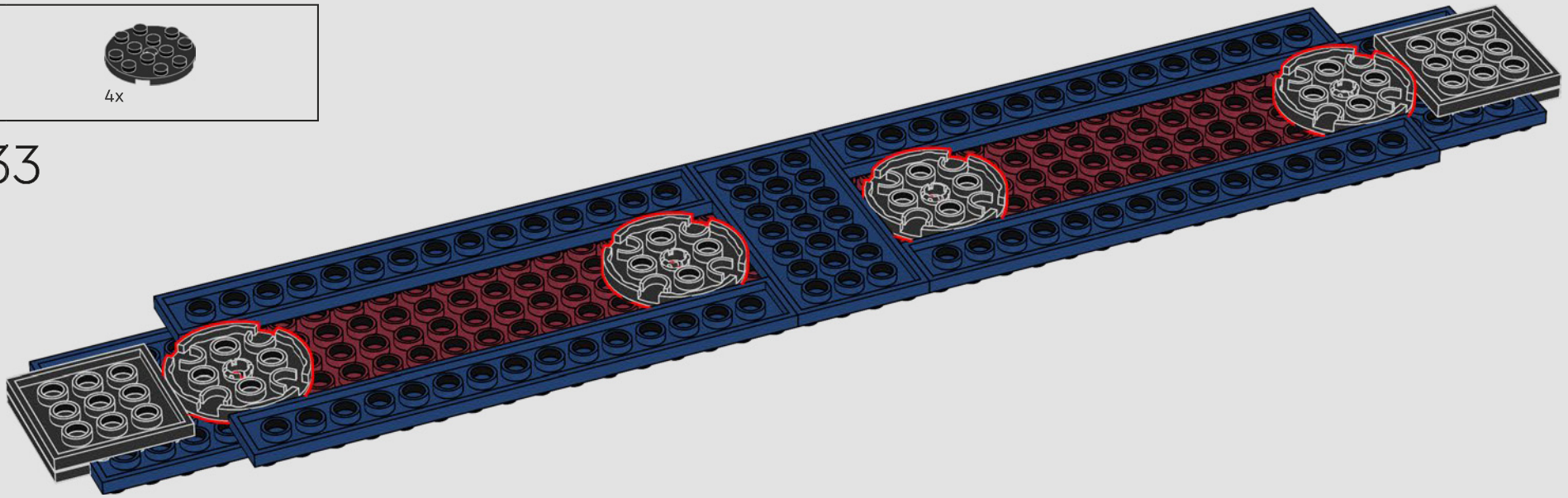

34





35

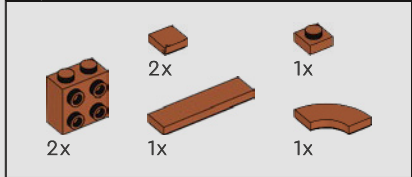
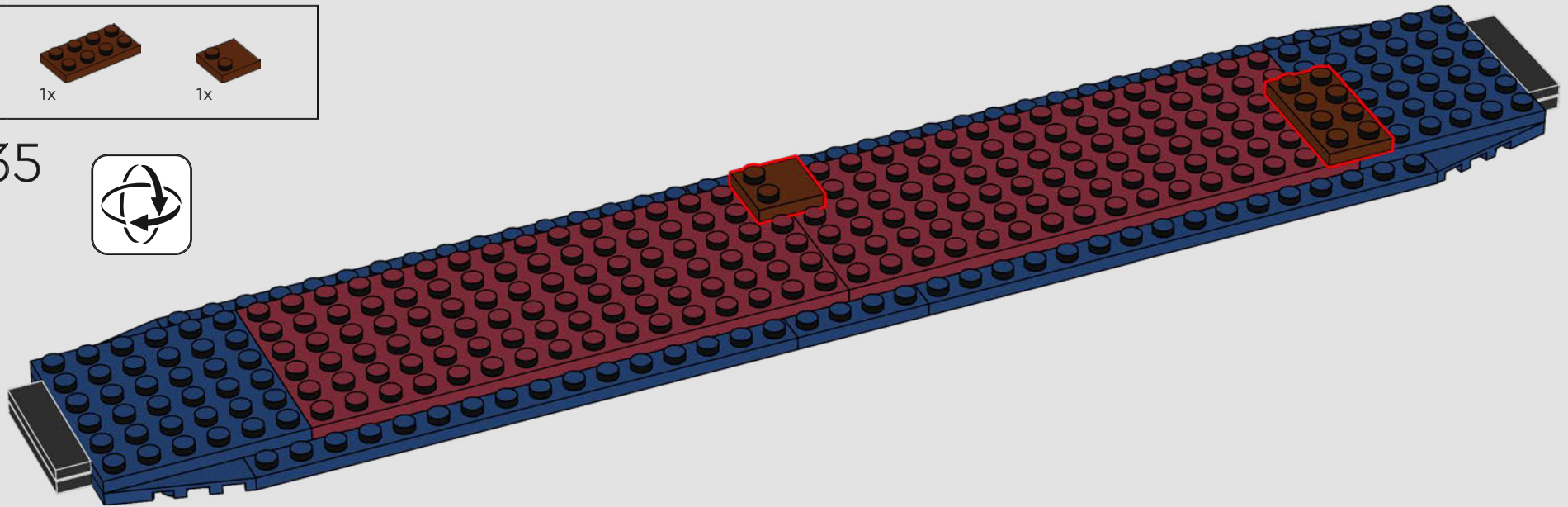

36

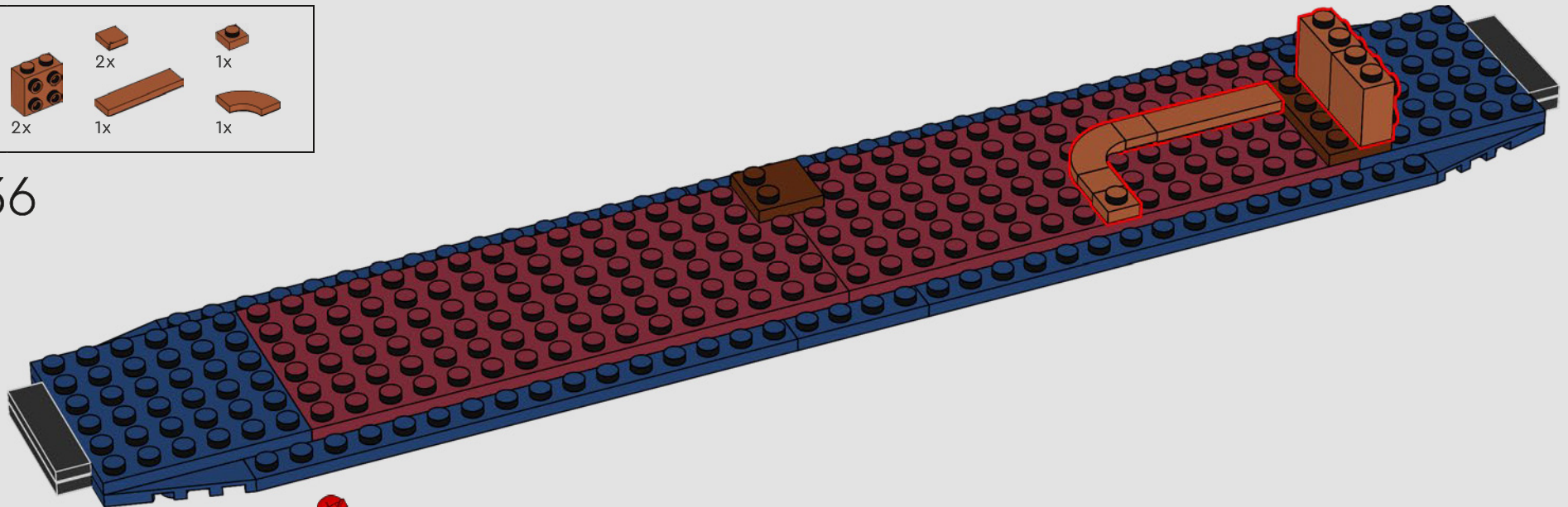



37

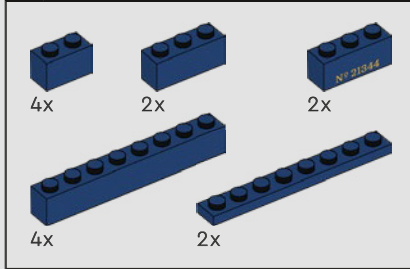
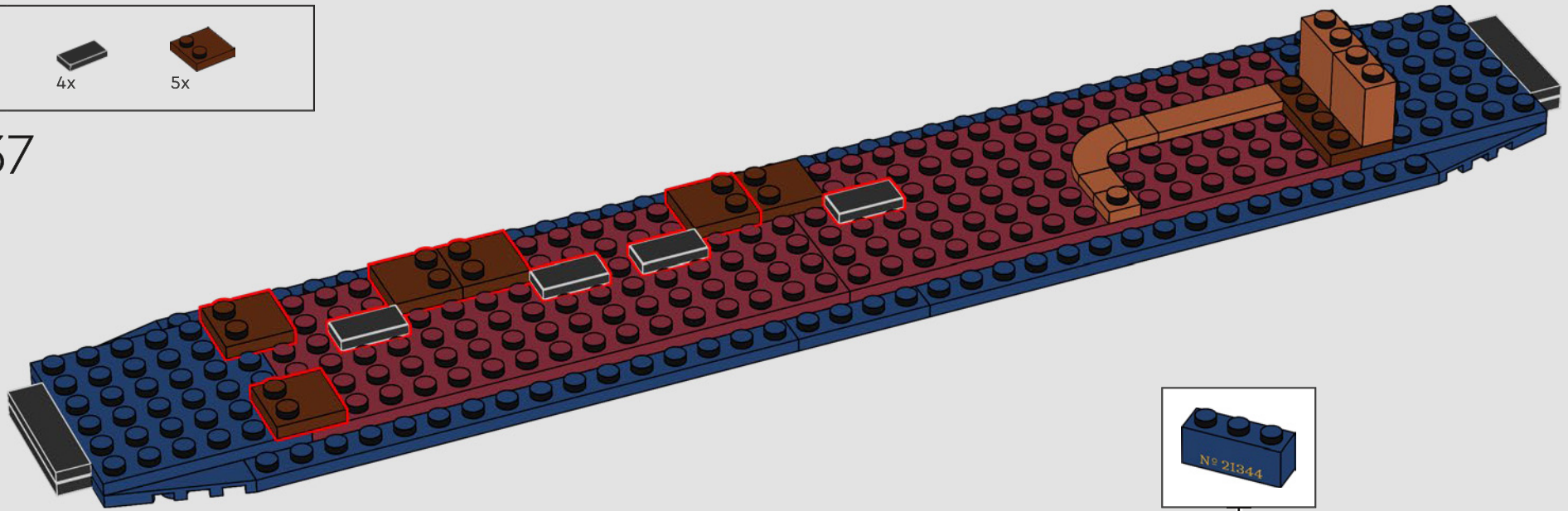

38

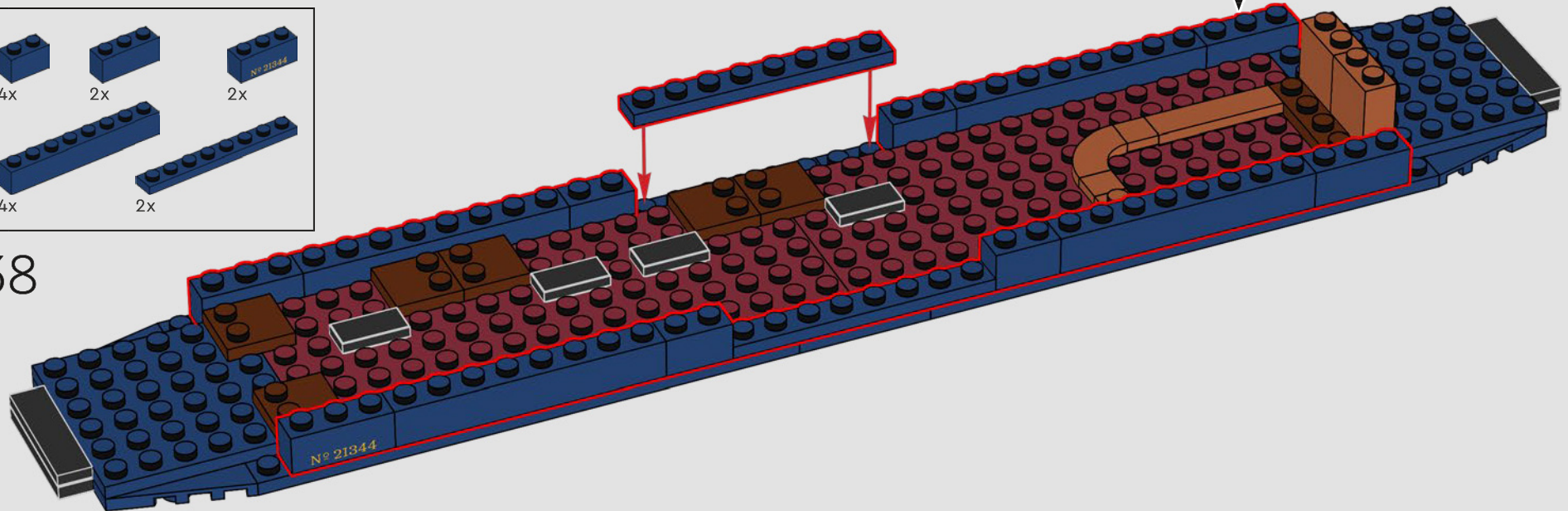

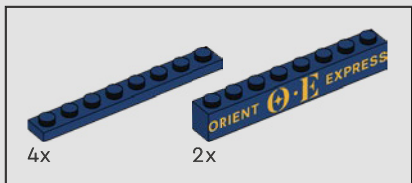

39

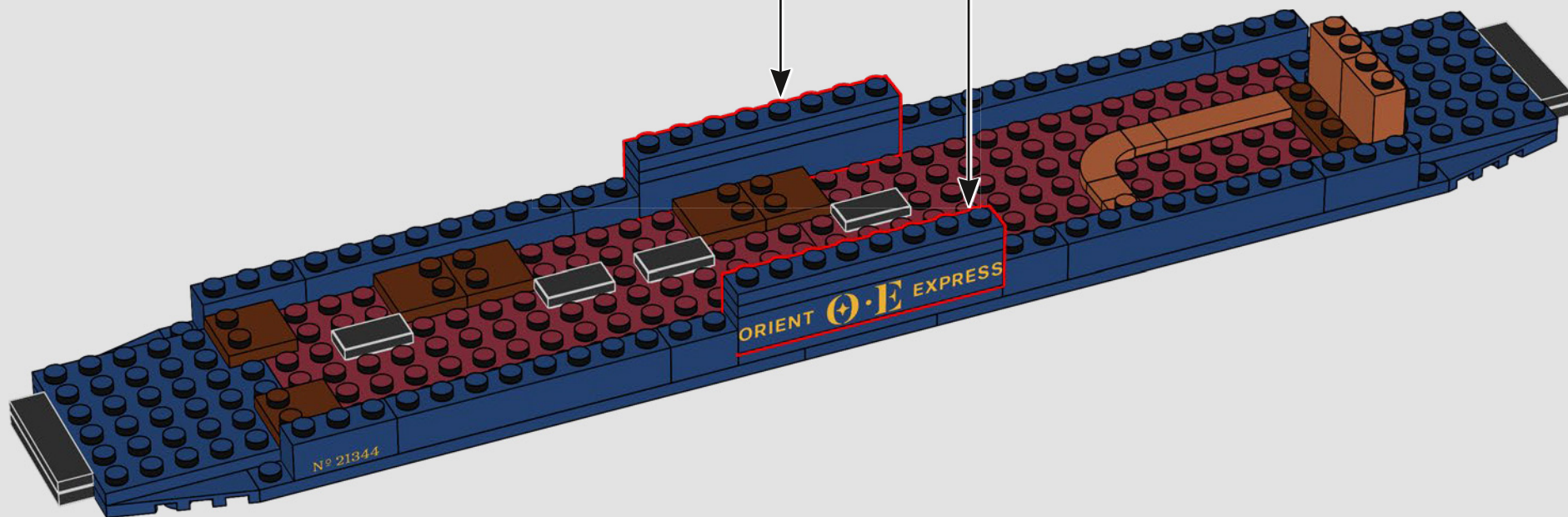
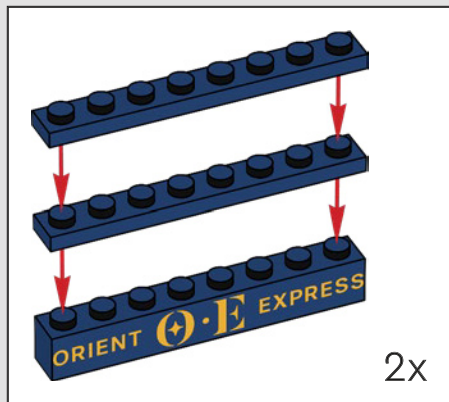

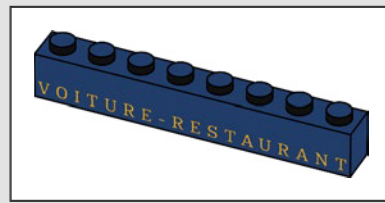
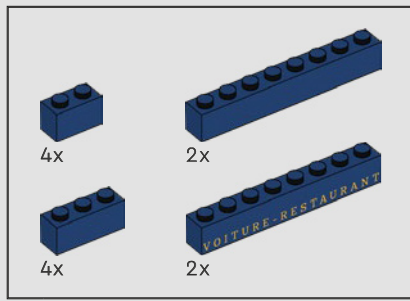

40

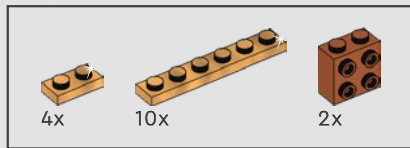
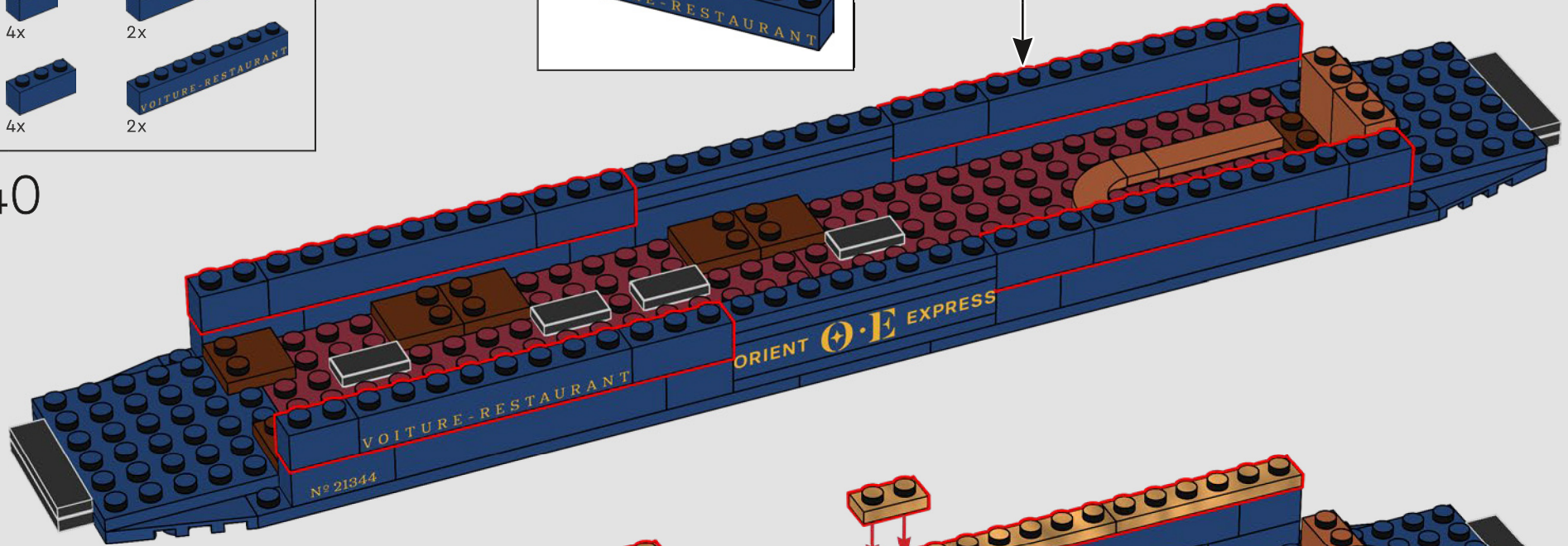

41

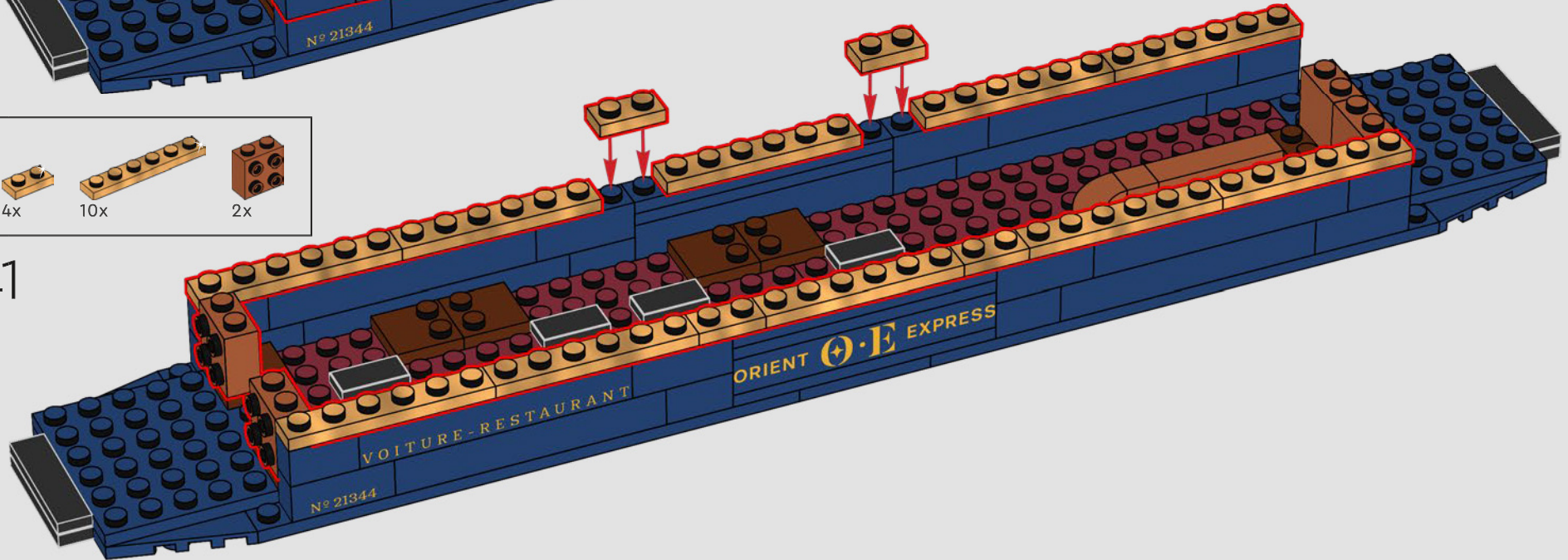

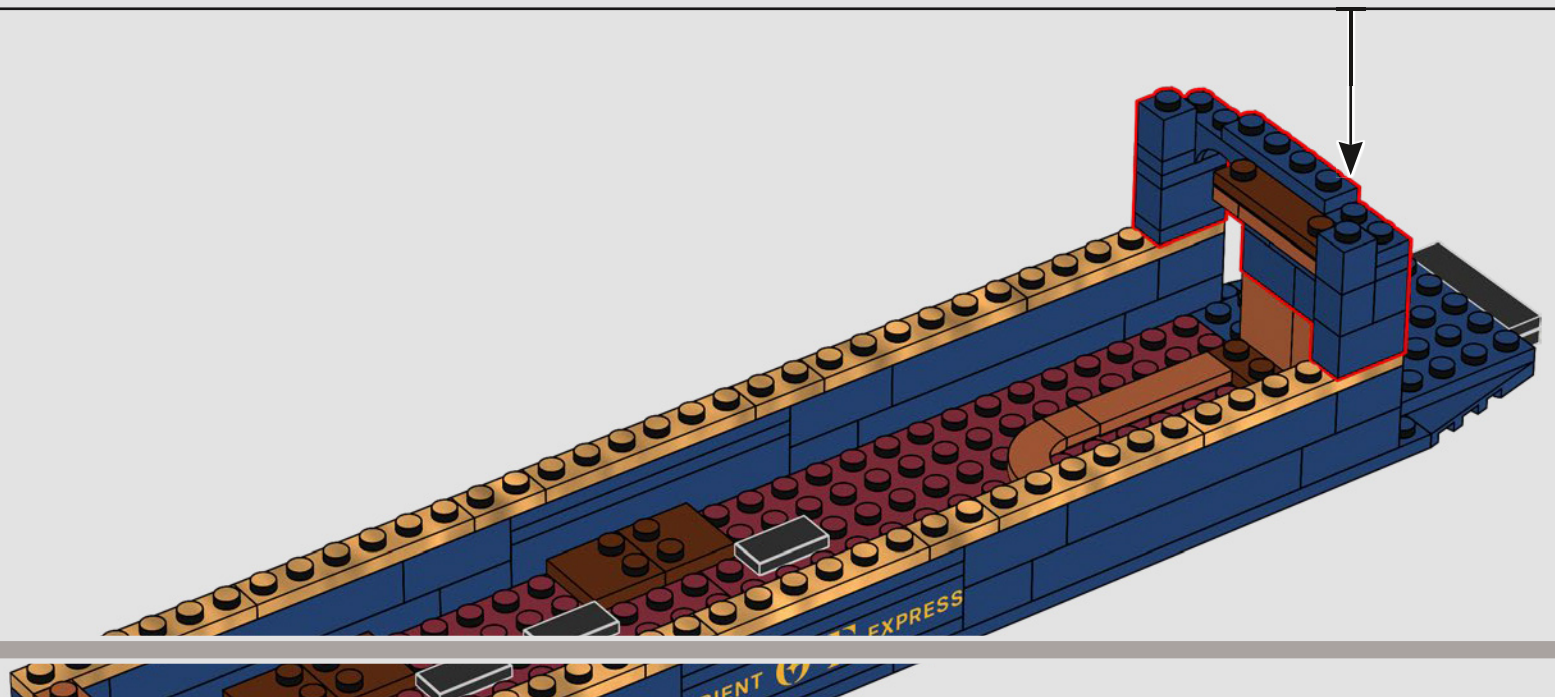
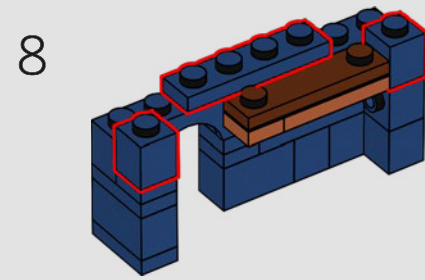
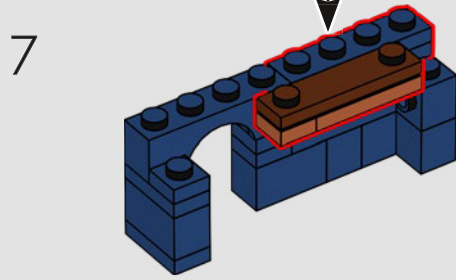
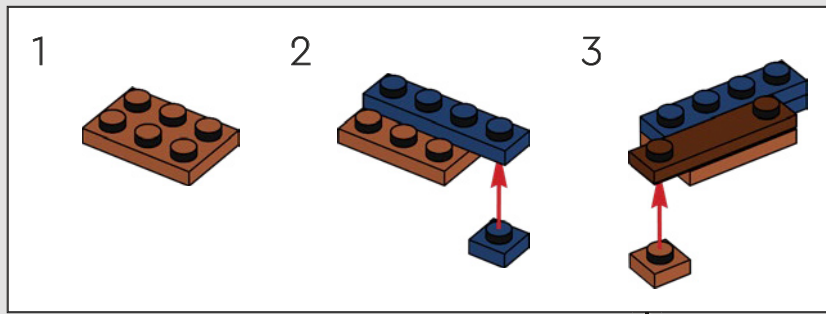

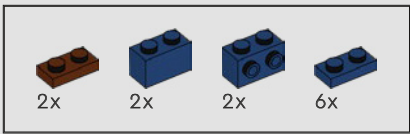

43

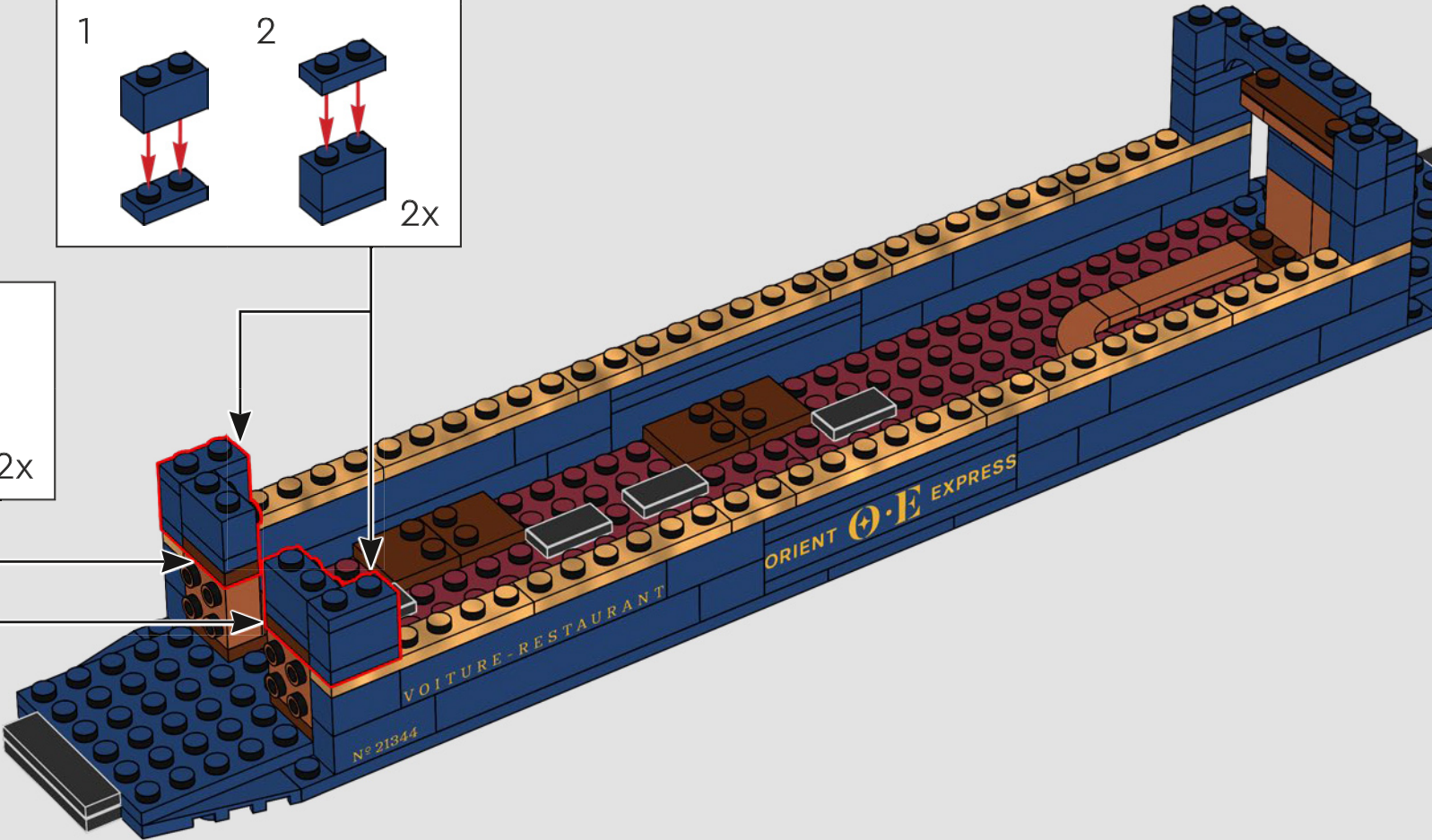
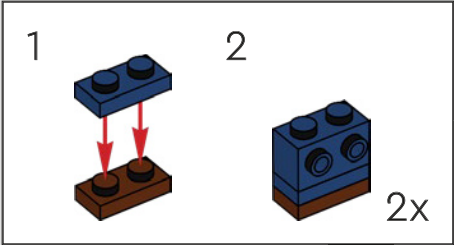
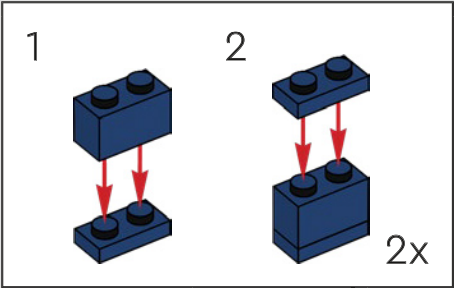

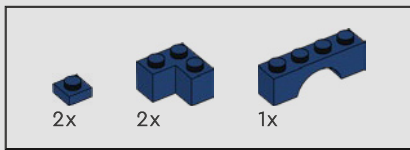

44

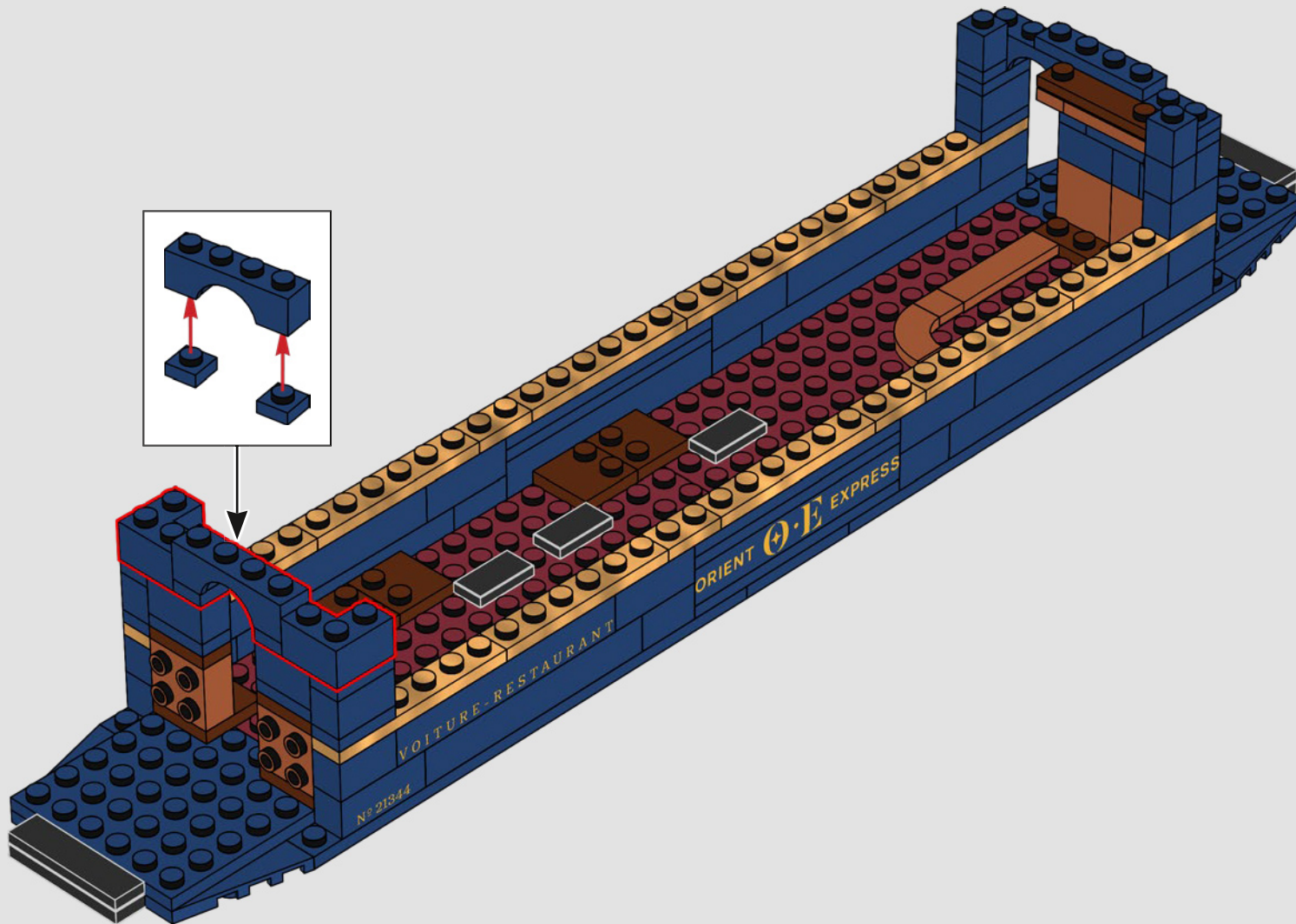

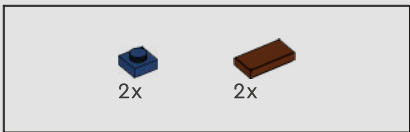

45

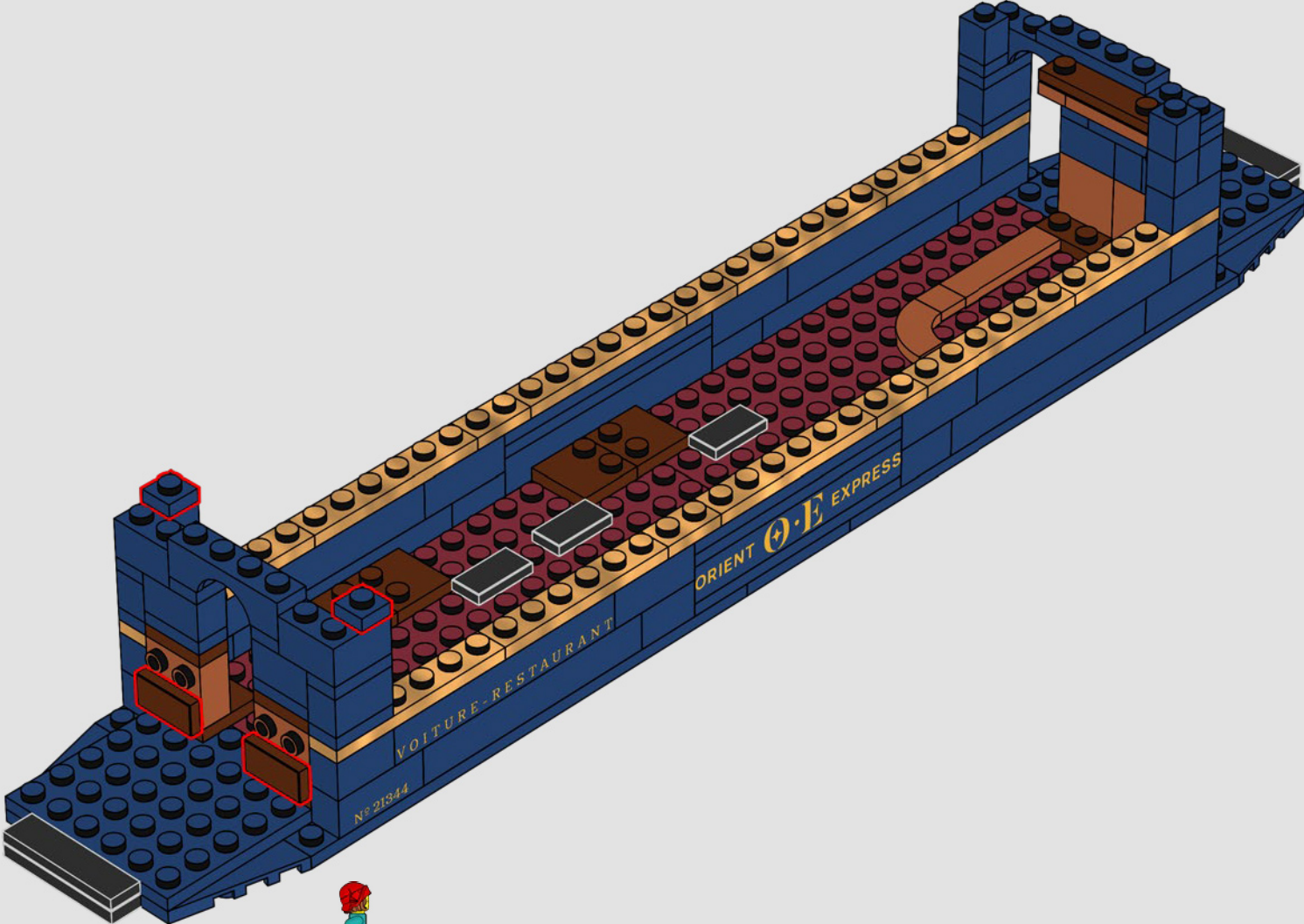

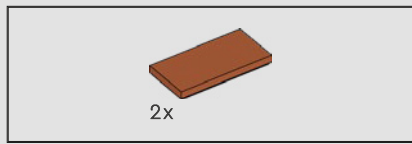

46

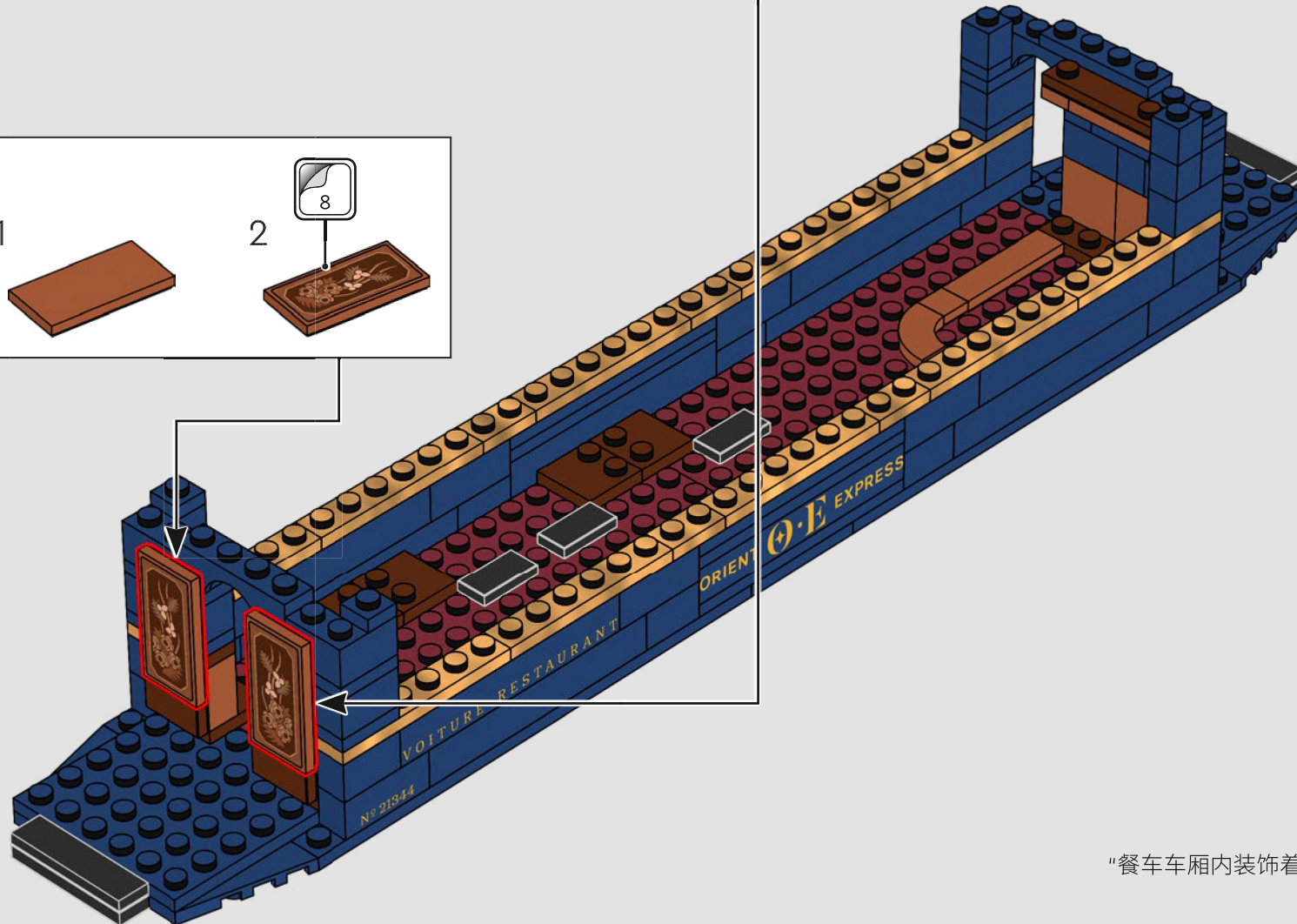
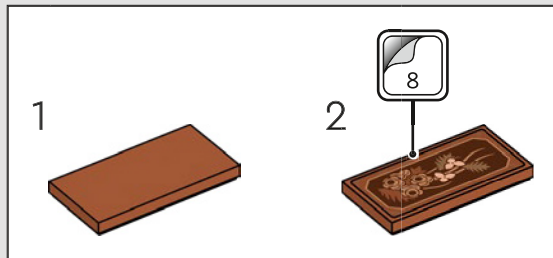
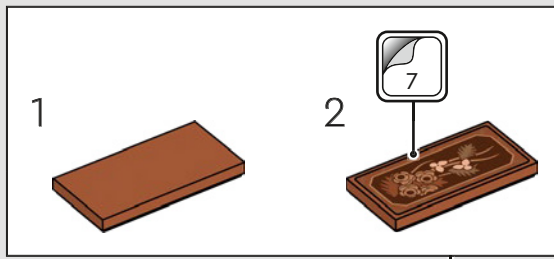

“餐车车厢内装饰着带有异域花朵的精美木镶板。”

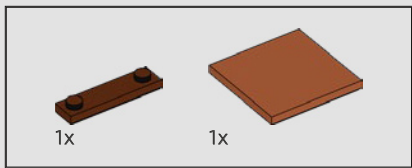

47

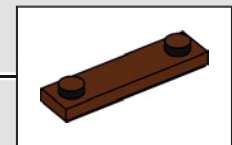
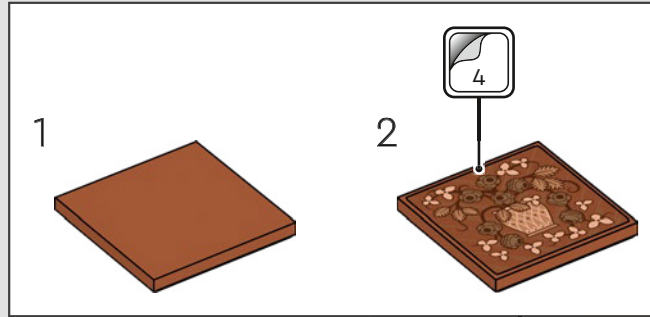
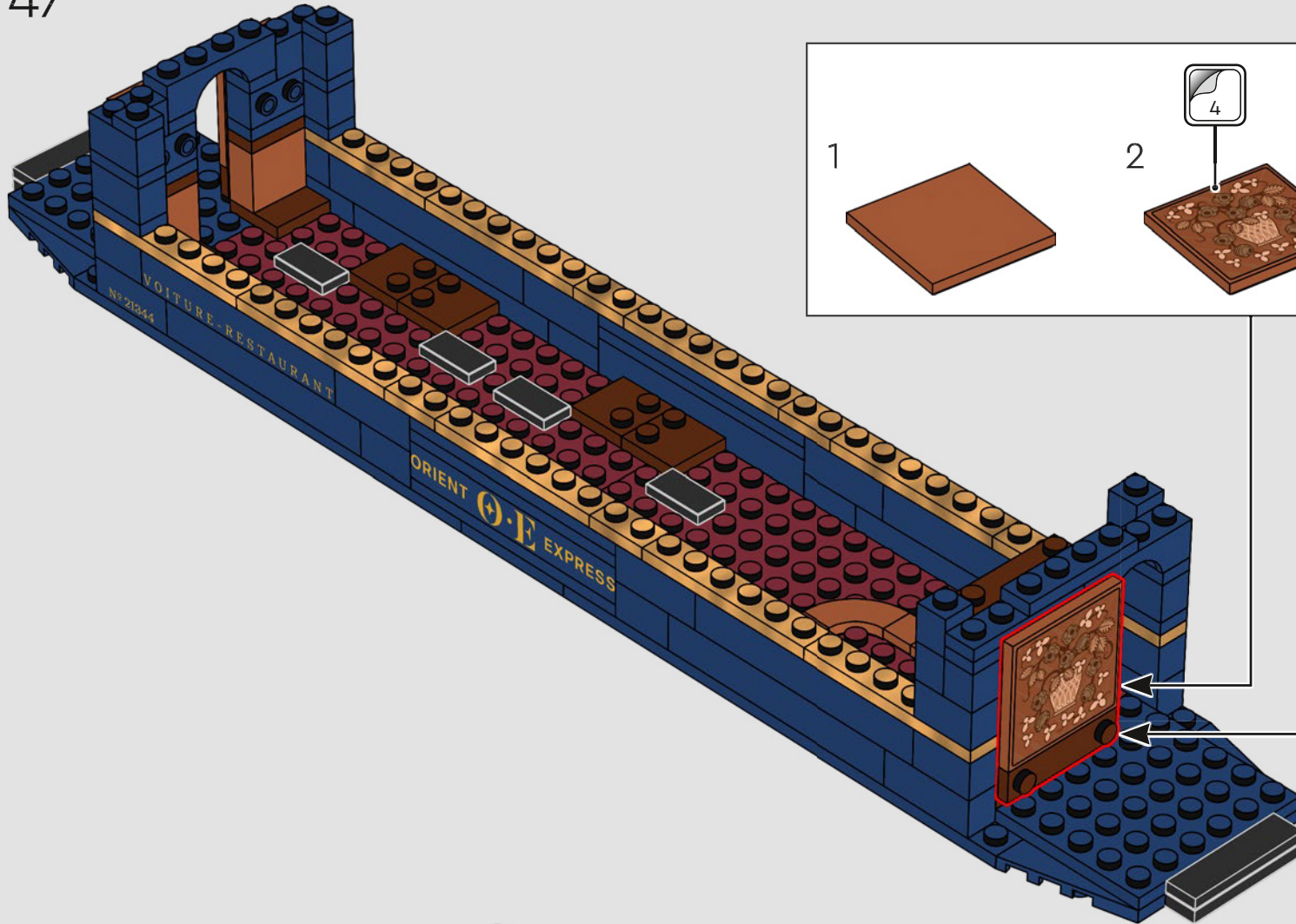

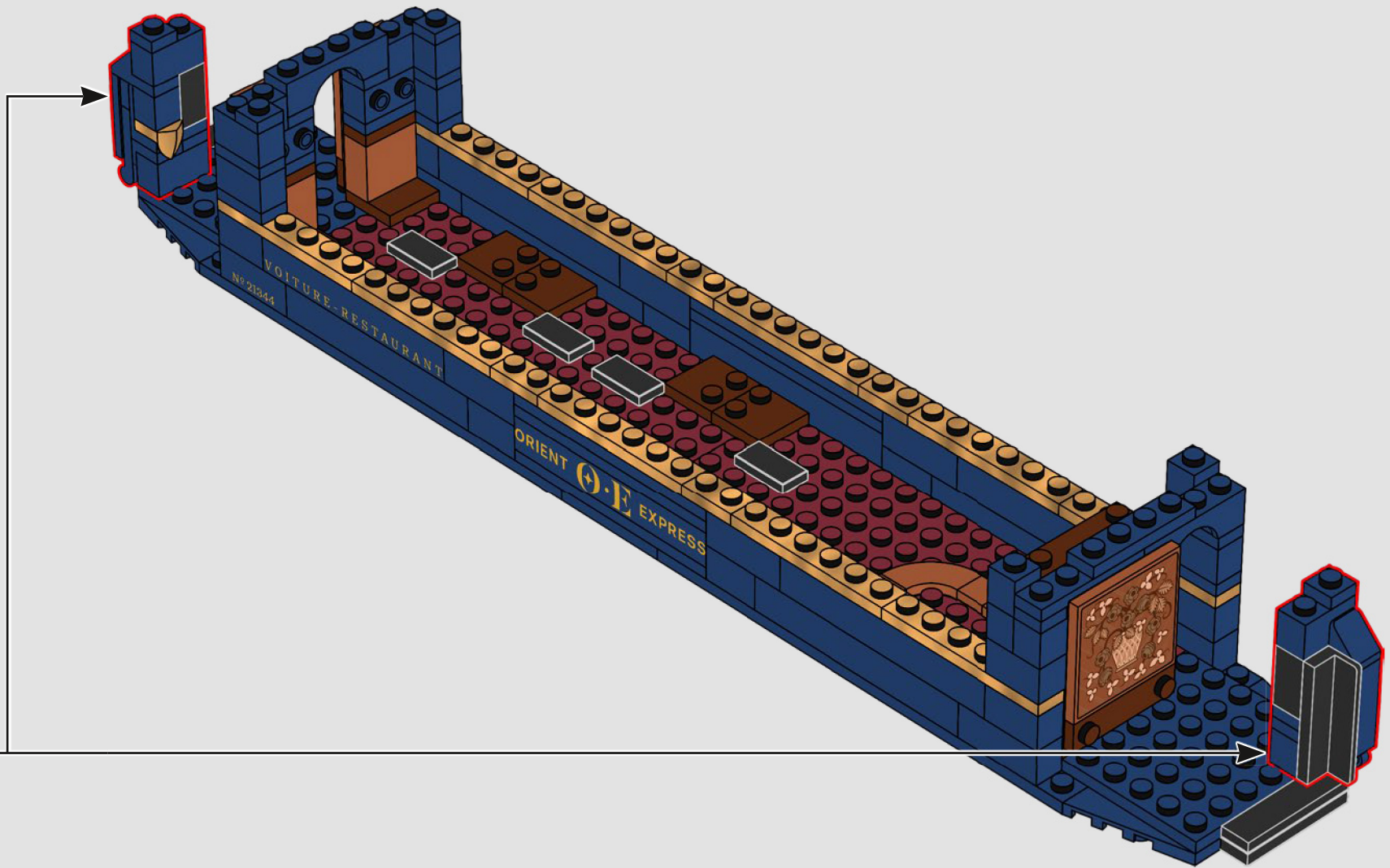

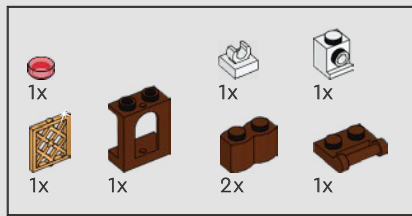

49

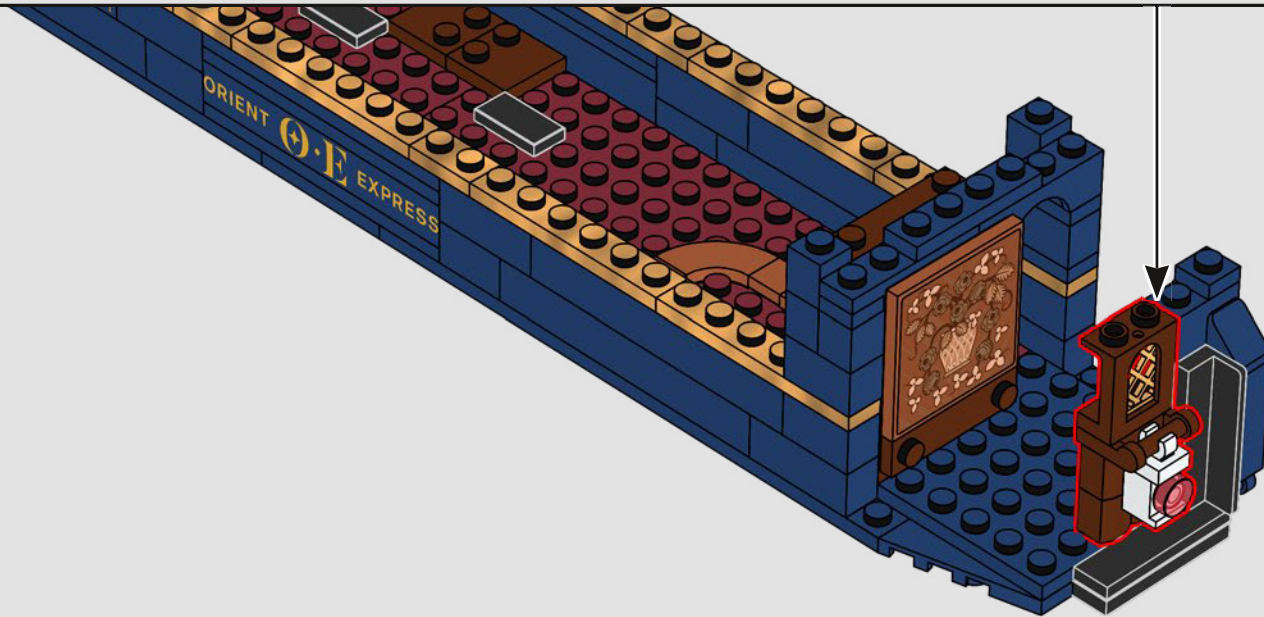
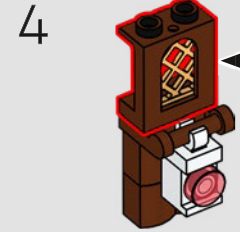
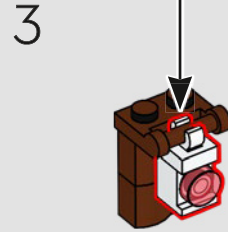
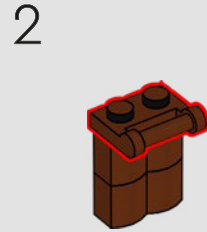
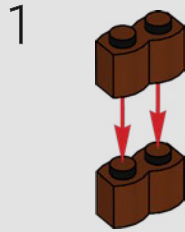
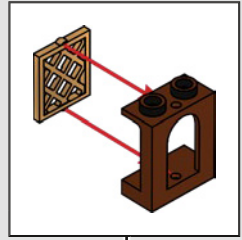
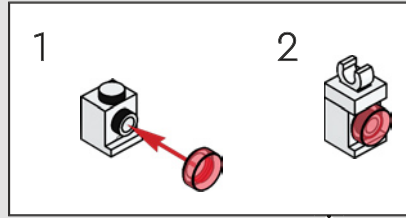



2x



2x



4x



2x



4x



2x



4x



2x



2x



2x



2x

50

1

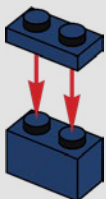

2

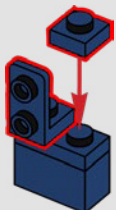

3



4

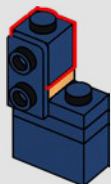

5

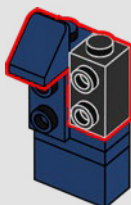

6

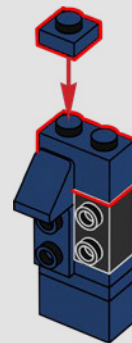

7

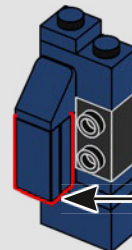

8

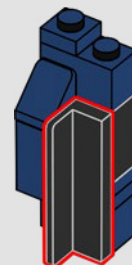

2x



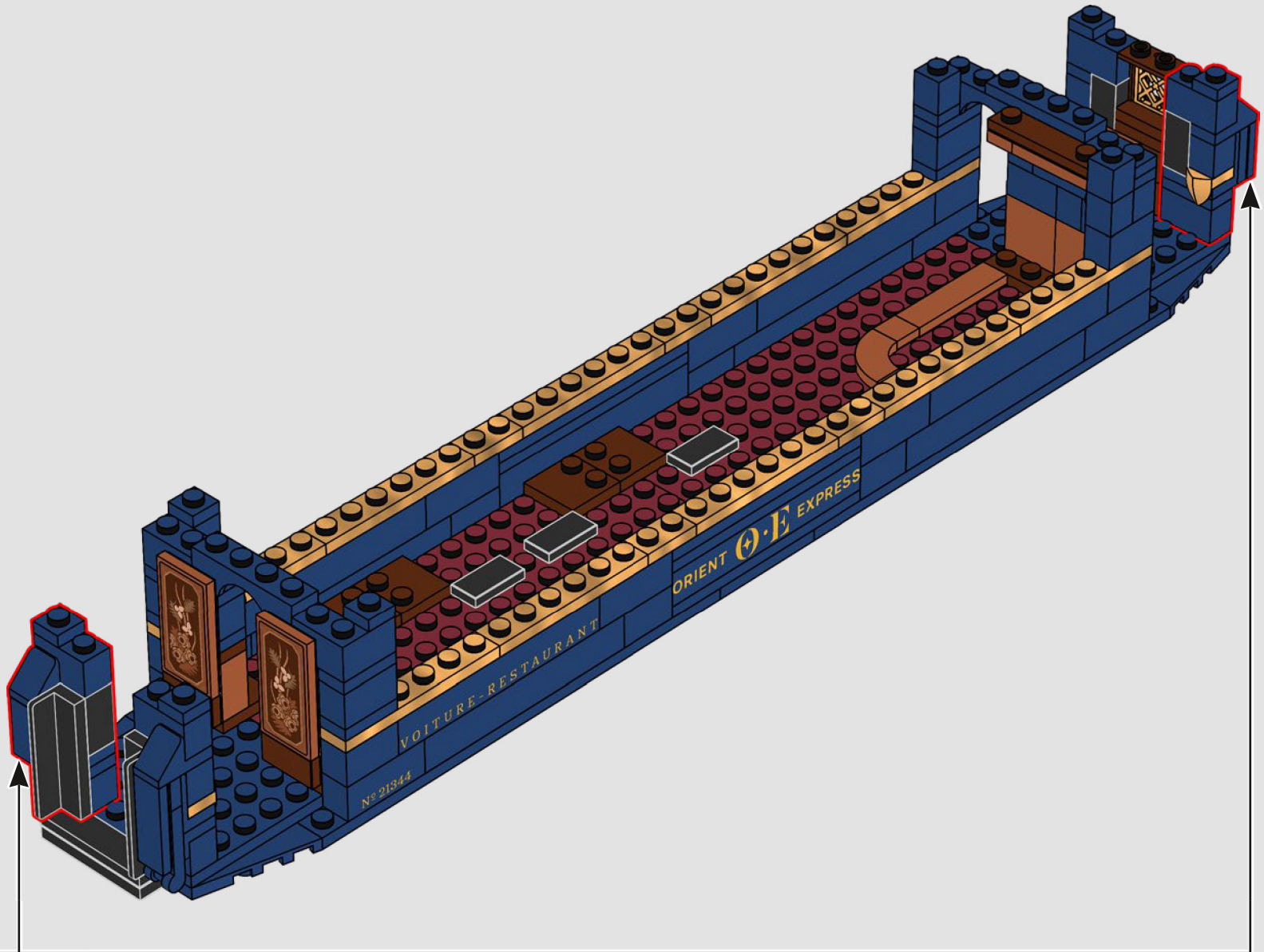

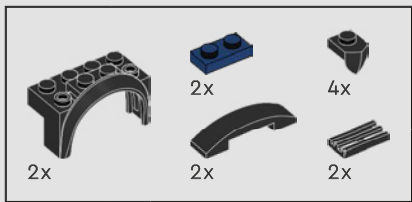

51

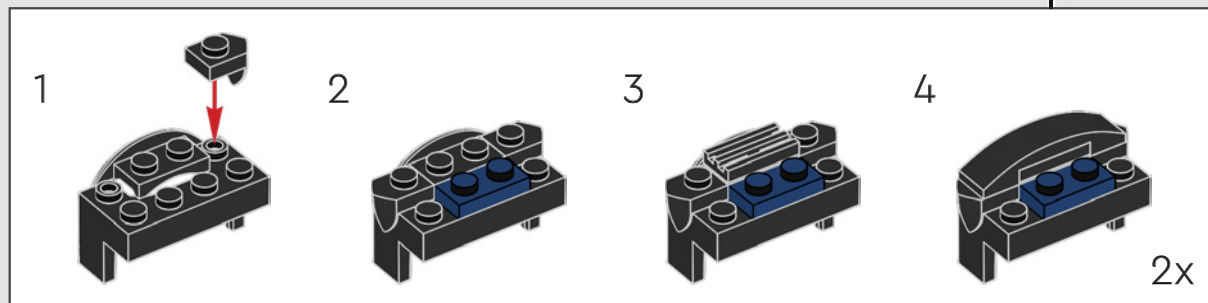
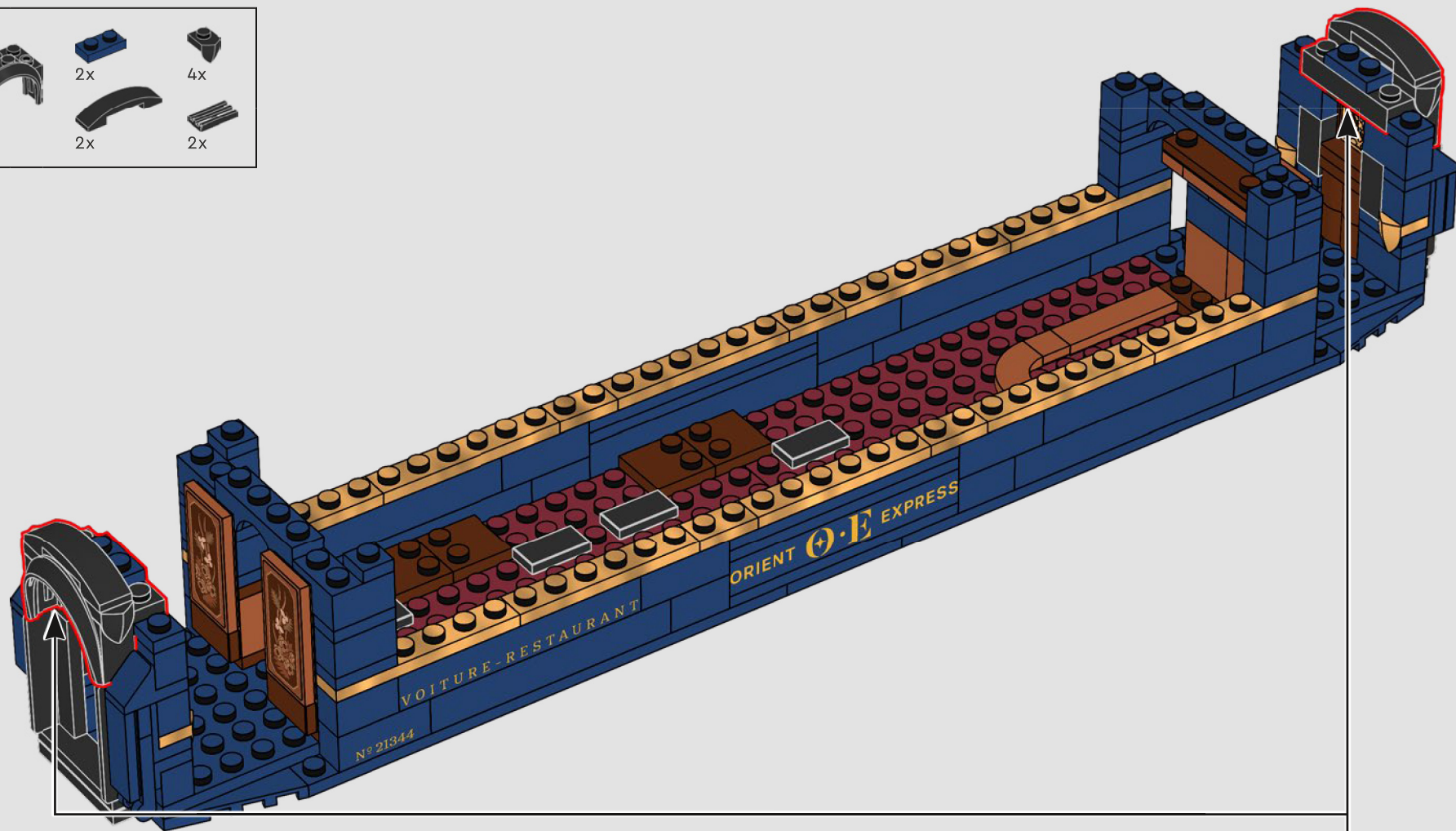

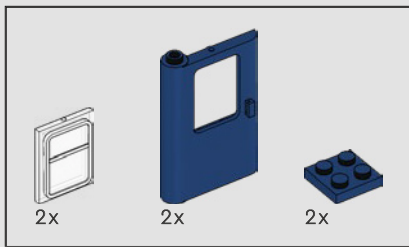

52

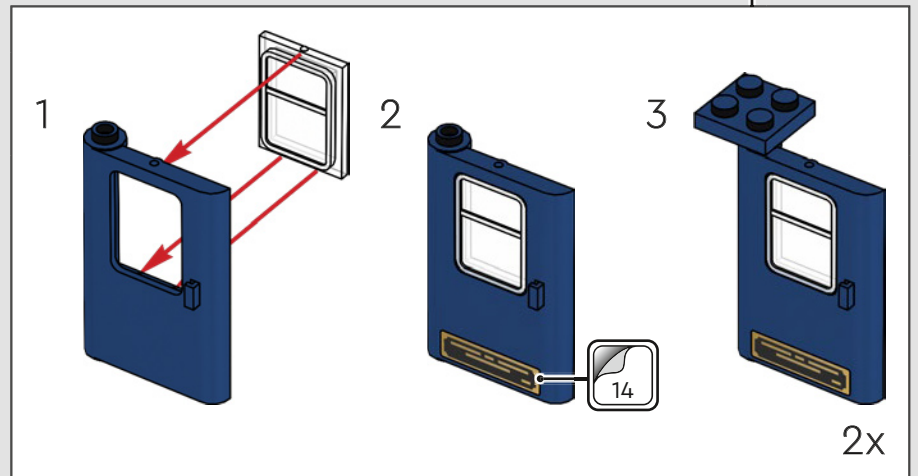
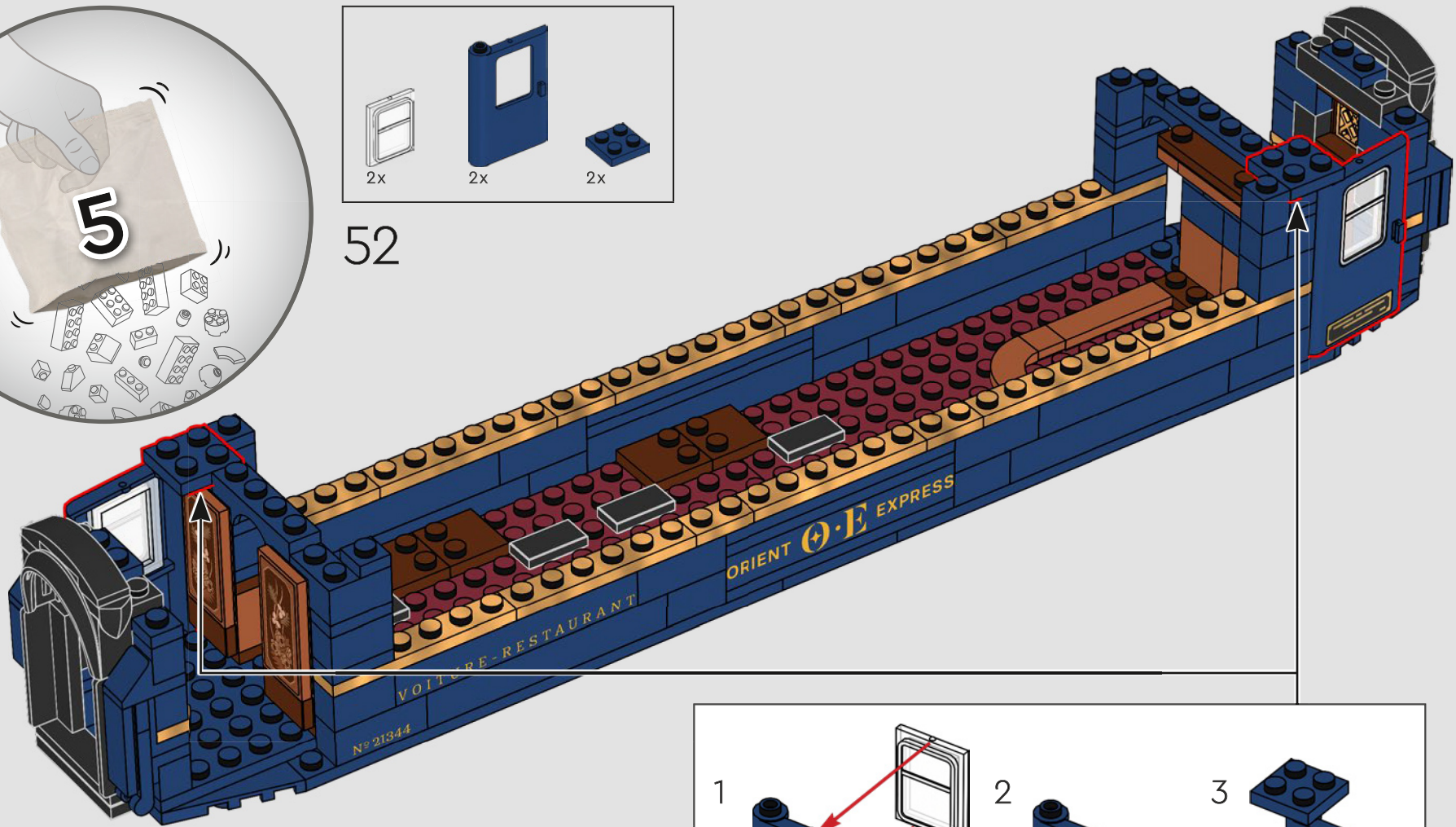

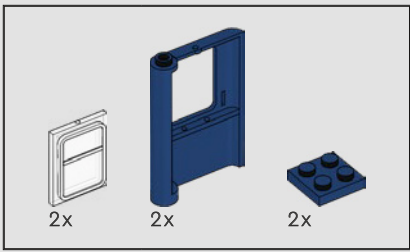

53

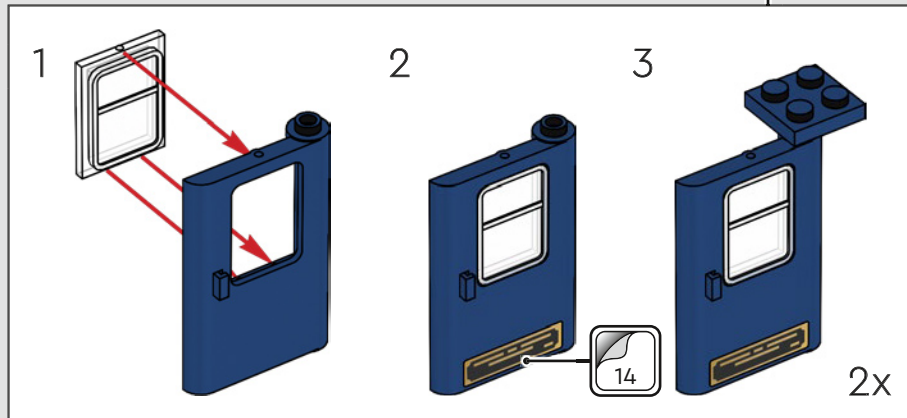
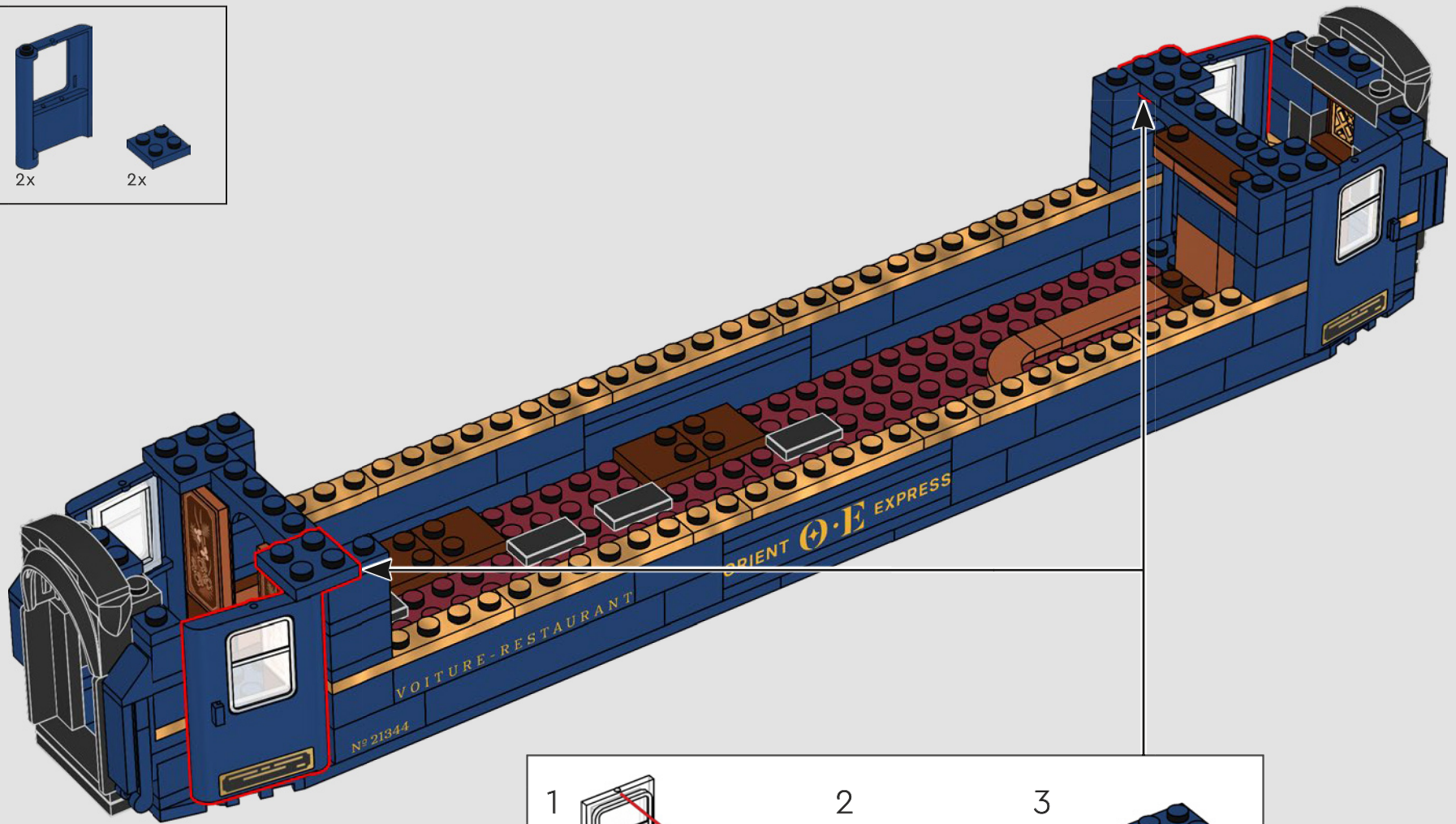

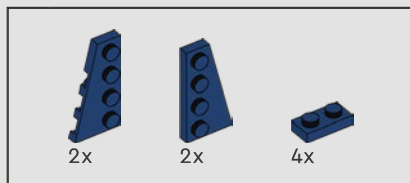

54

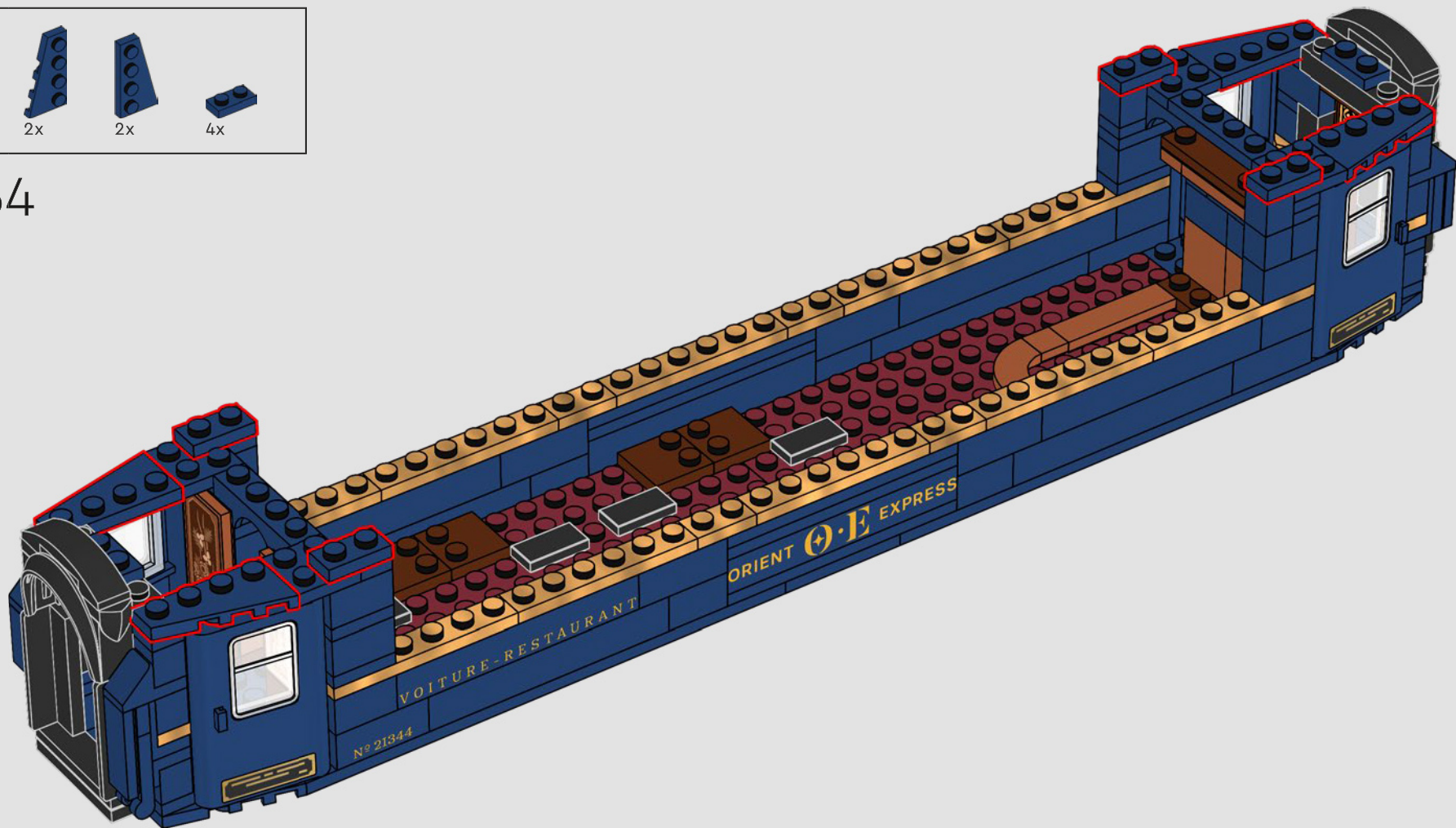

“每扇车门上都带有铭牌，作为质量的标志。”

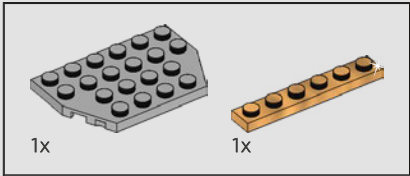
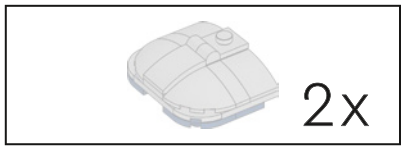

55

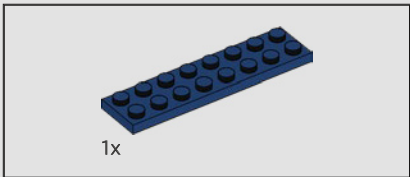
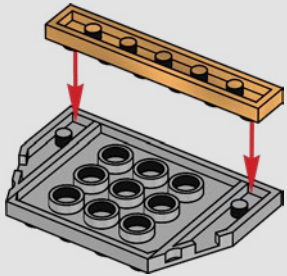

56

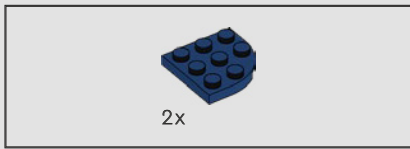
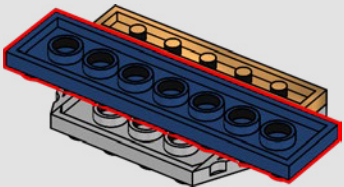

57

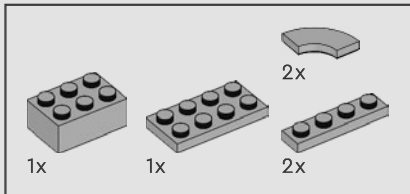
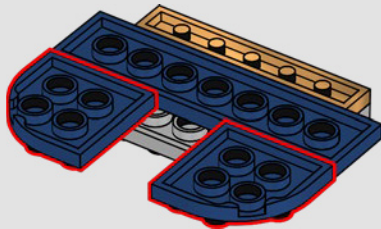

58

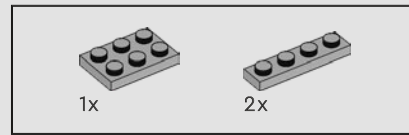
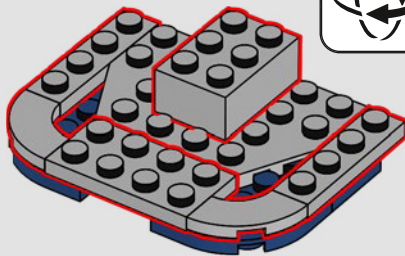

59

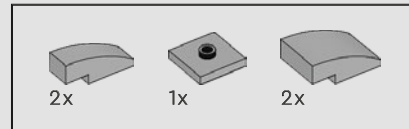
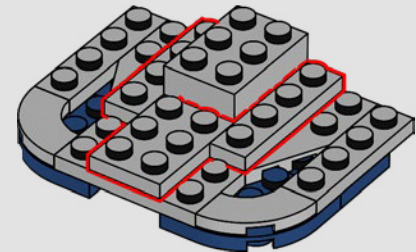

60

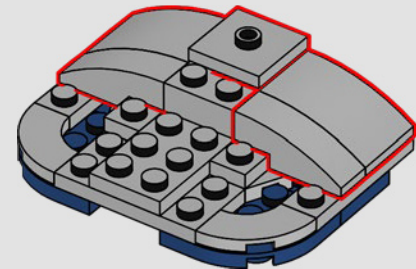

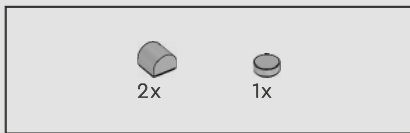

61

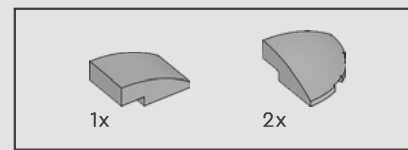
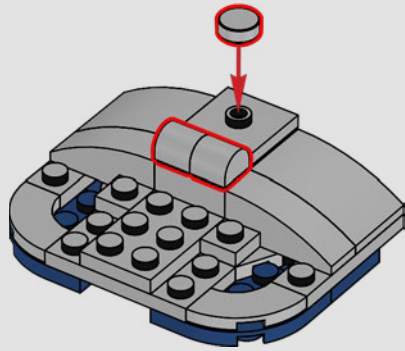

62

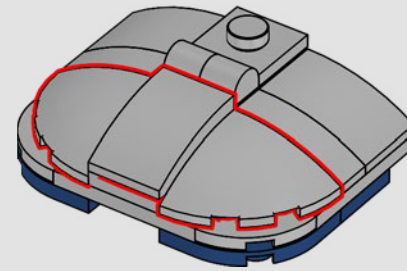

2x

63

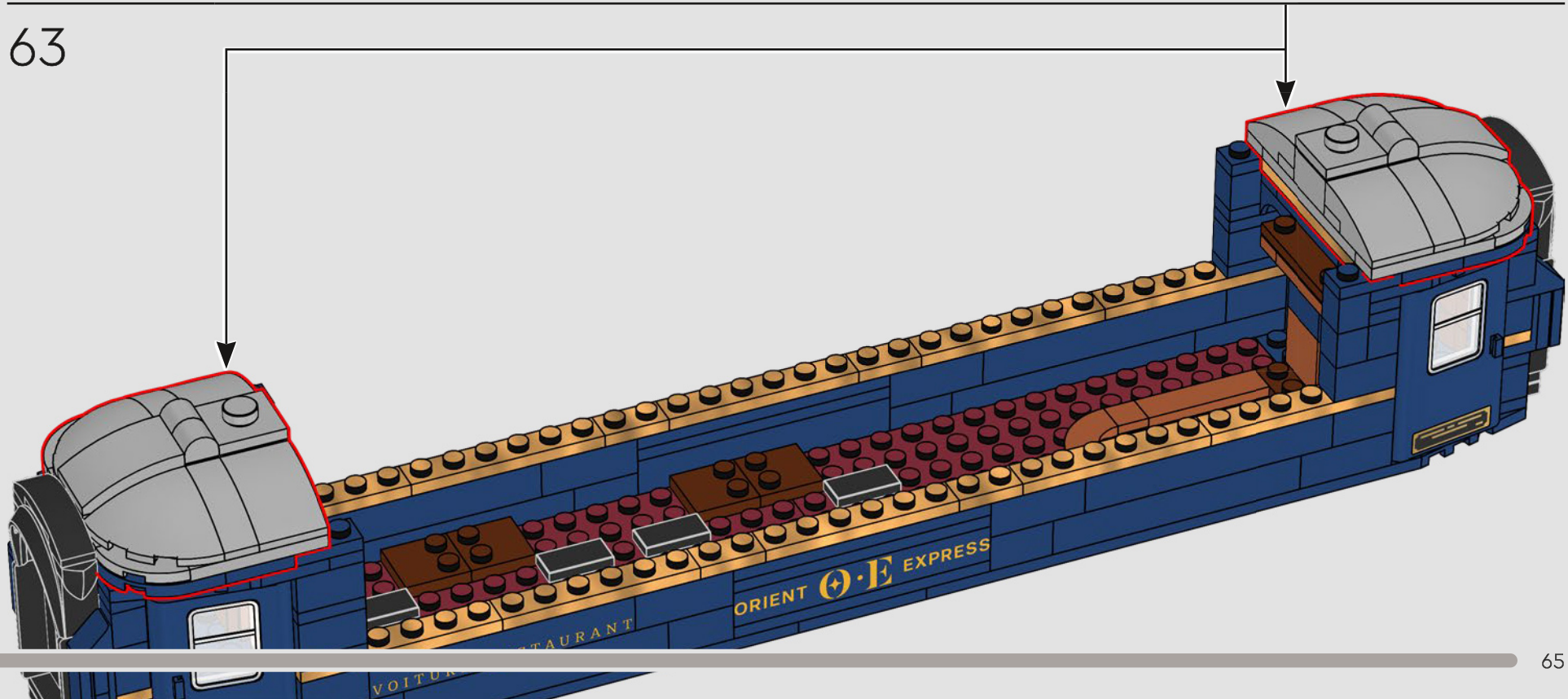

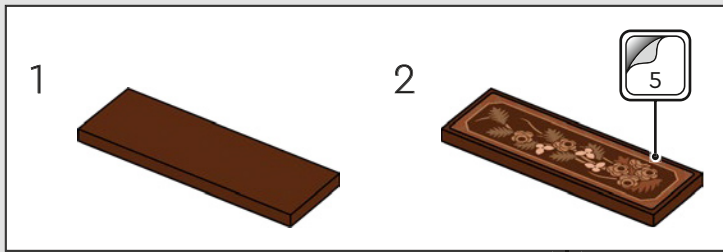
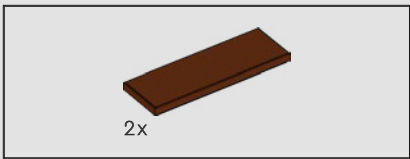

64

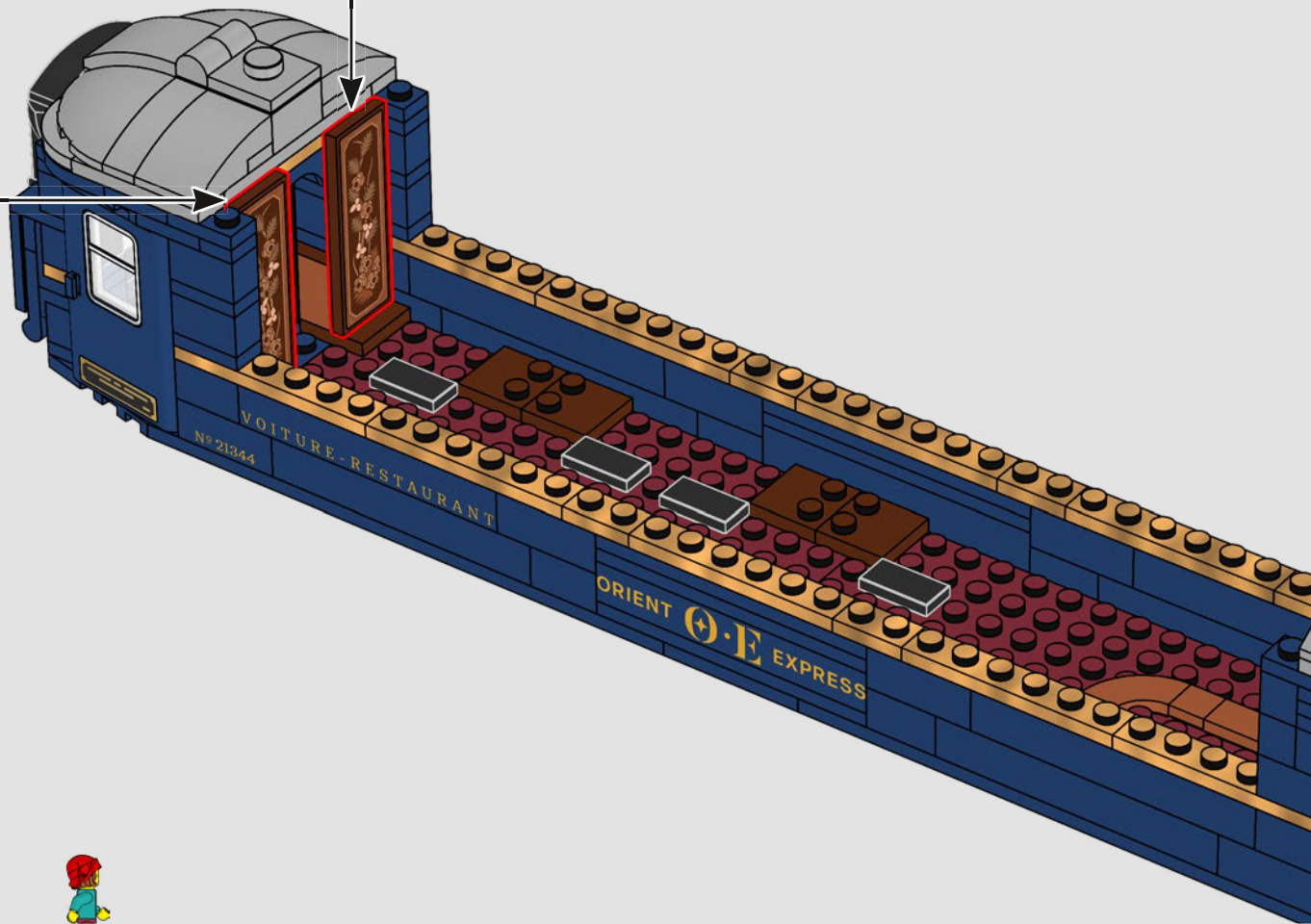
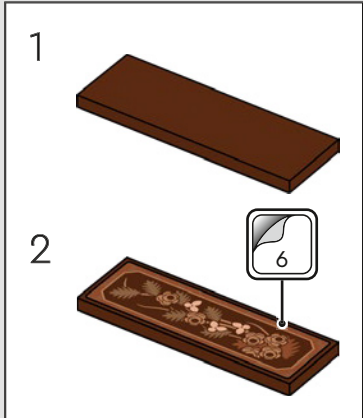

2



3

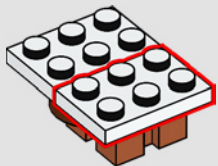

4

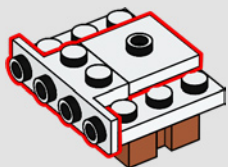

5

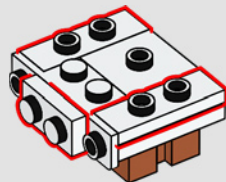

6

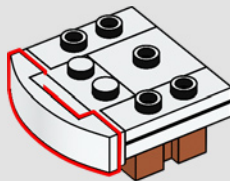

7

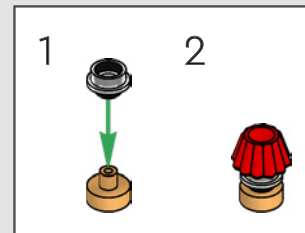
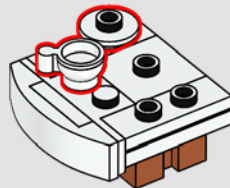

8



9

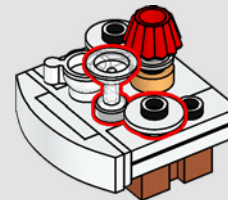

2x



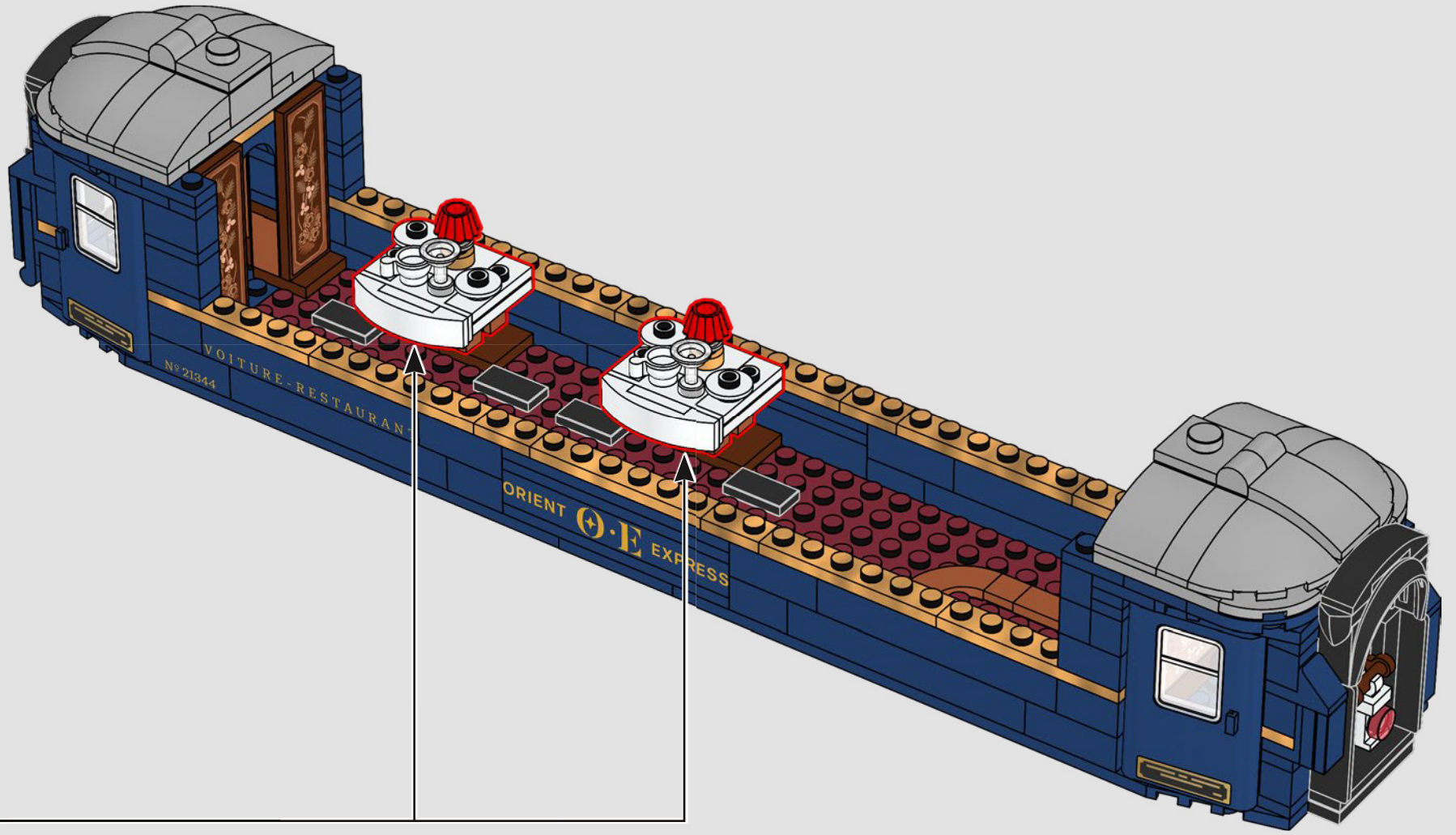

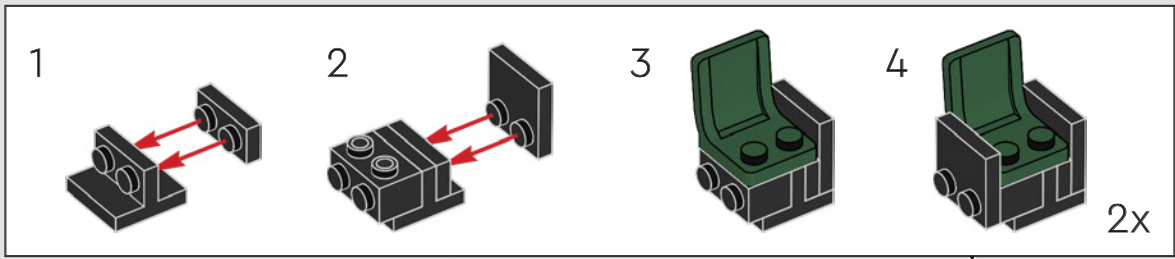
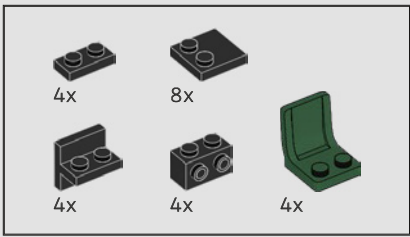

66

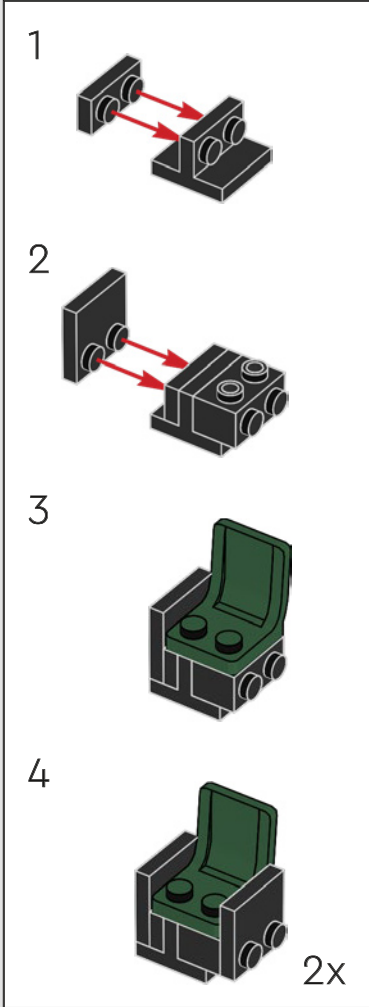

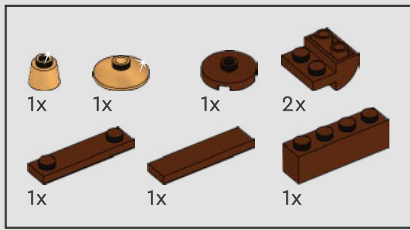

67

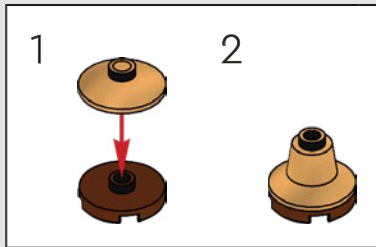
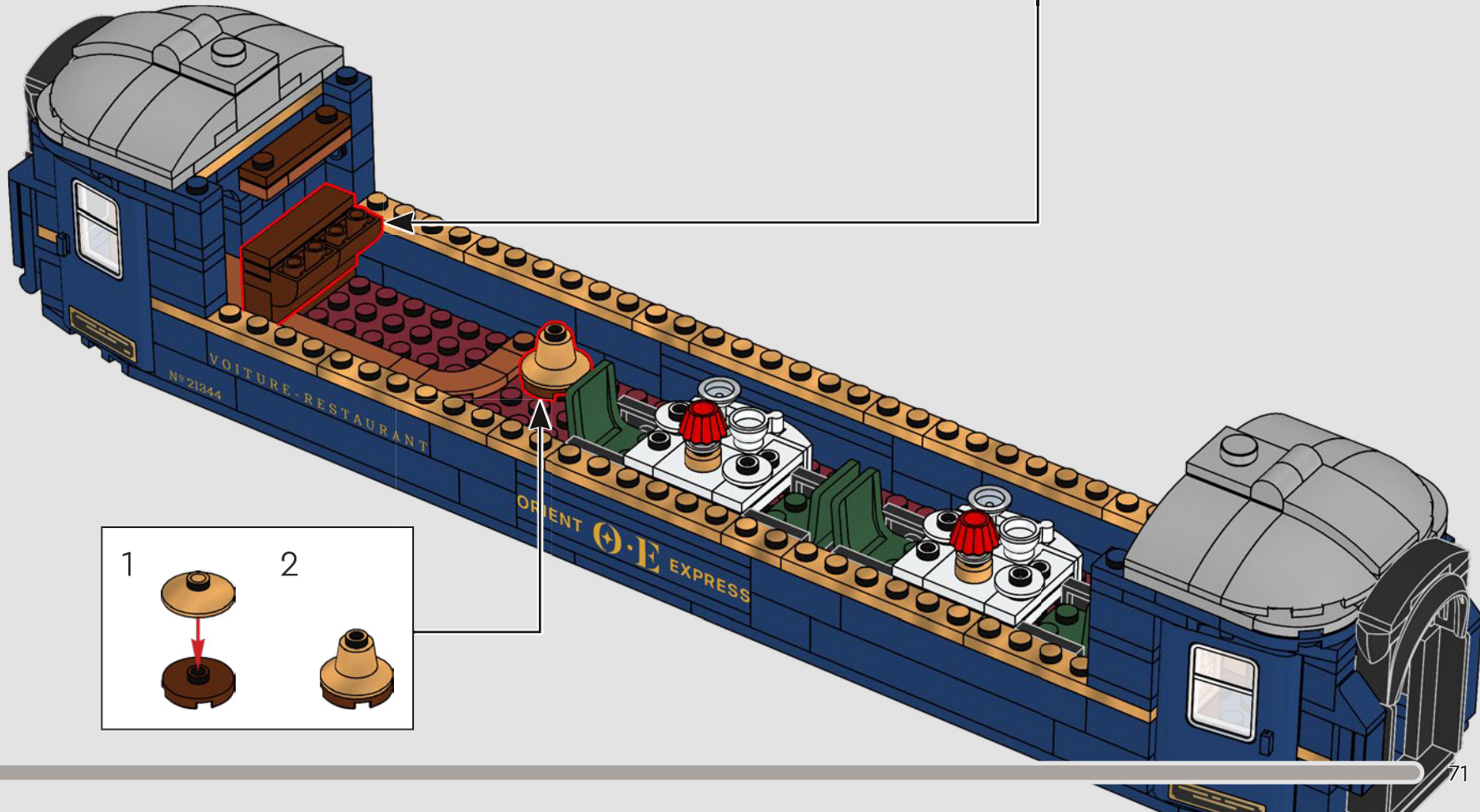
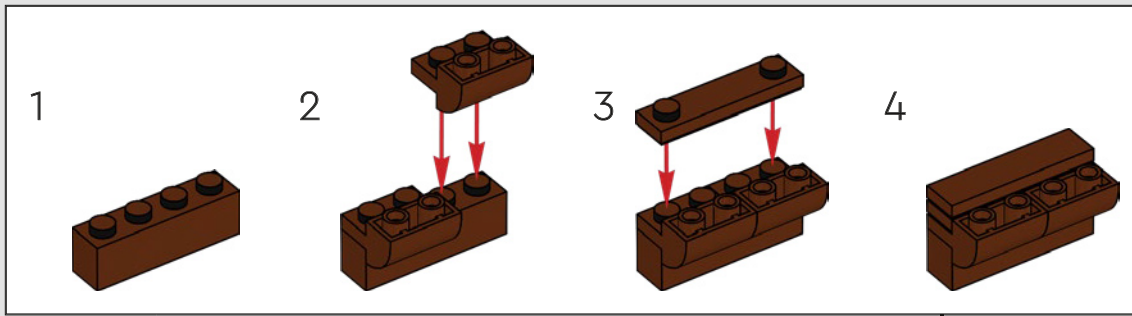



69

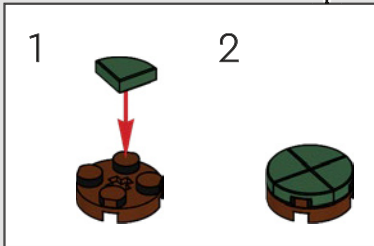
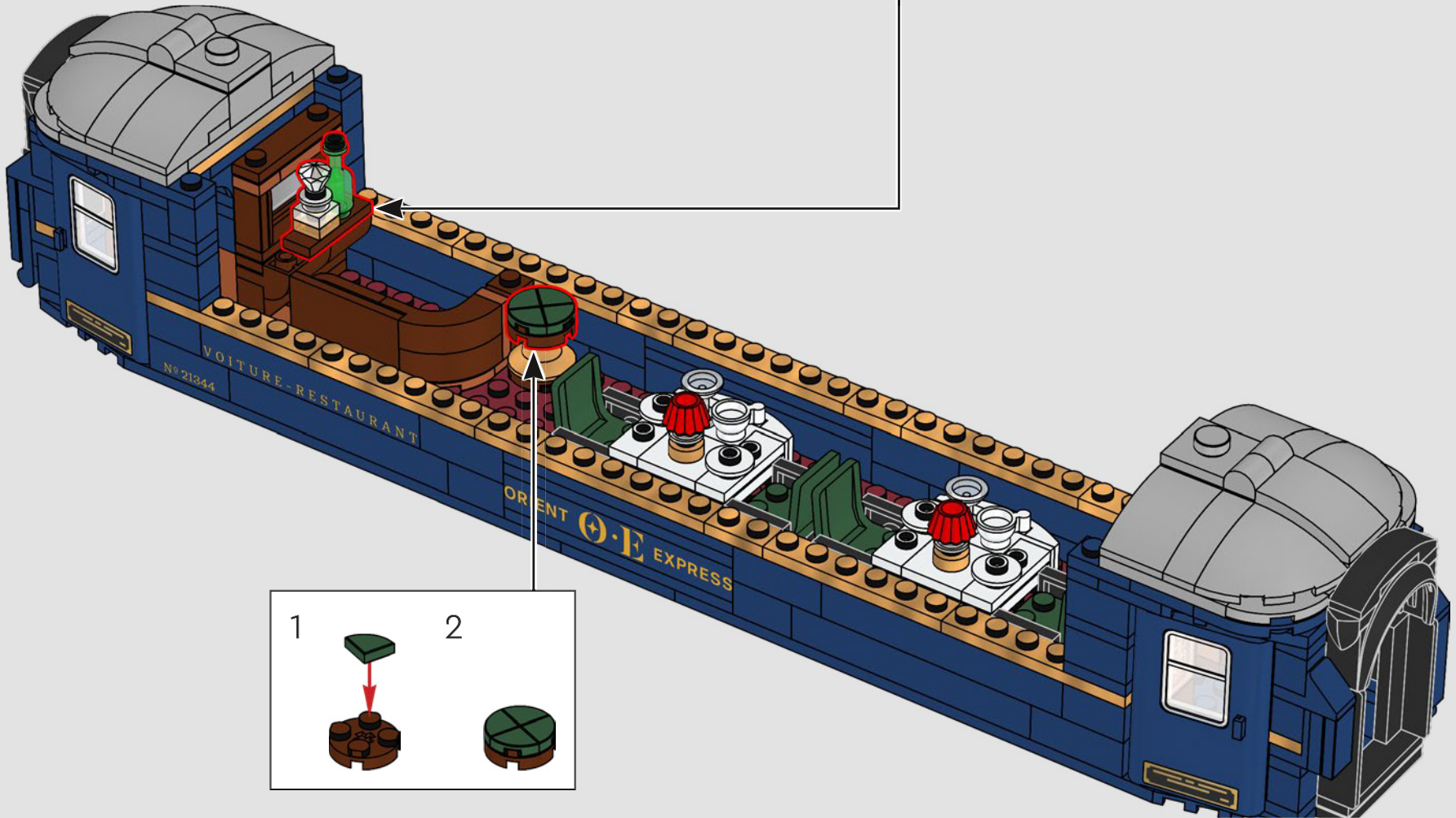
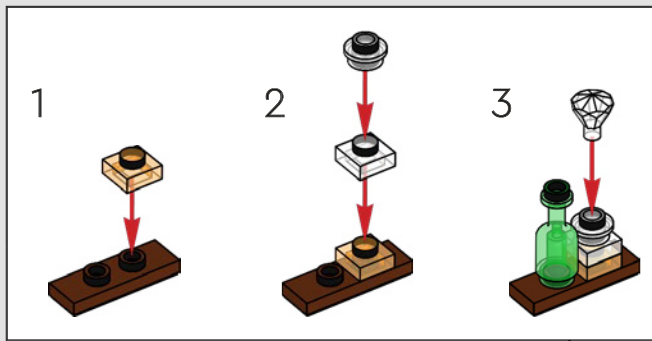

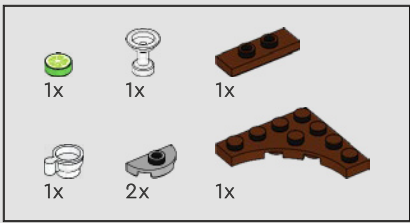

70

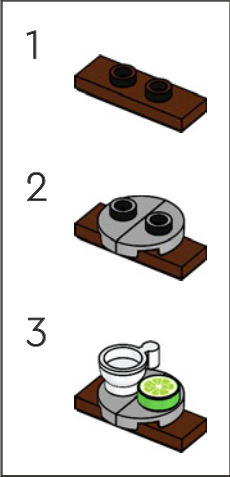
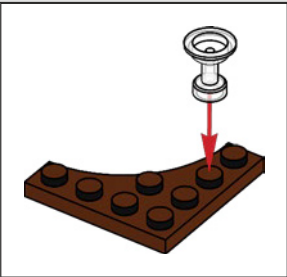

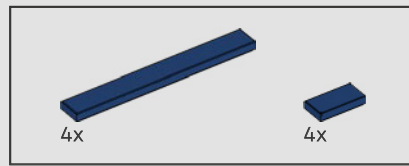

71



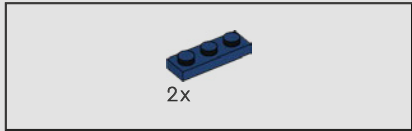
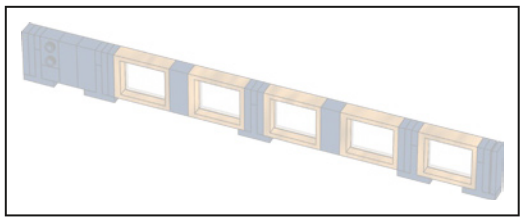

2x

72

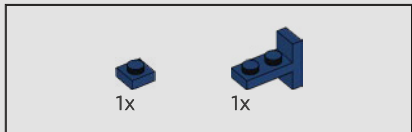
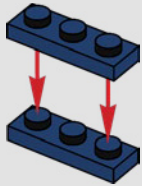

1x

1x

73

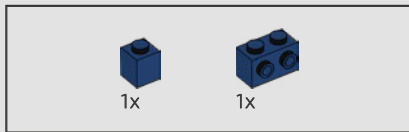
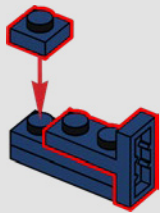

1x

1x

74

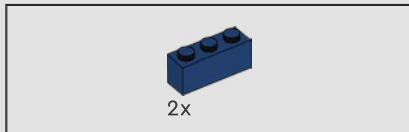
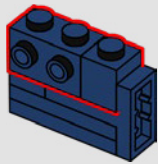

2x

75

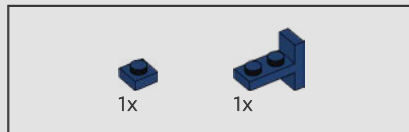
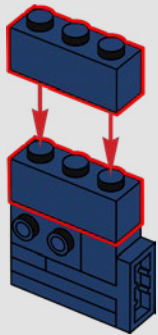

1x

1x

76

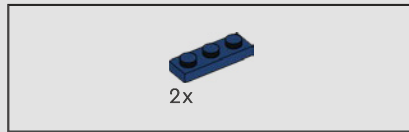
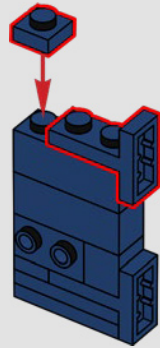

2x

77

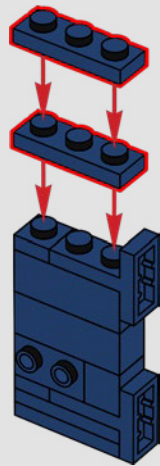

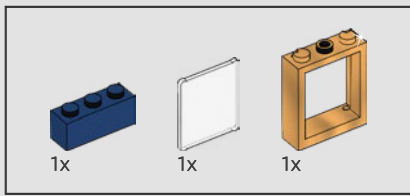

78

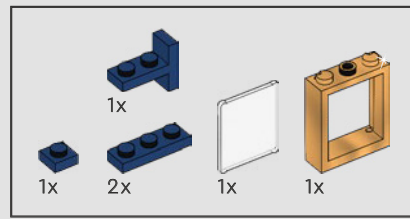
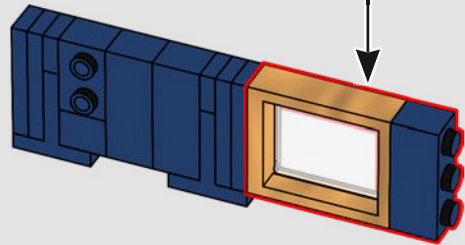
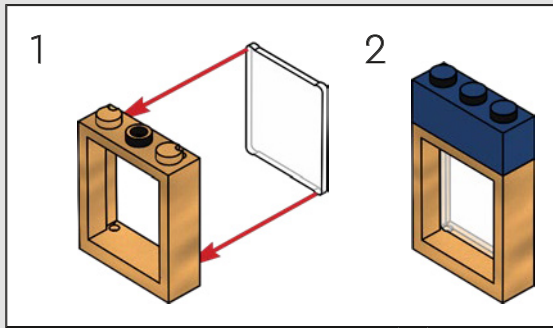

79

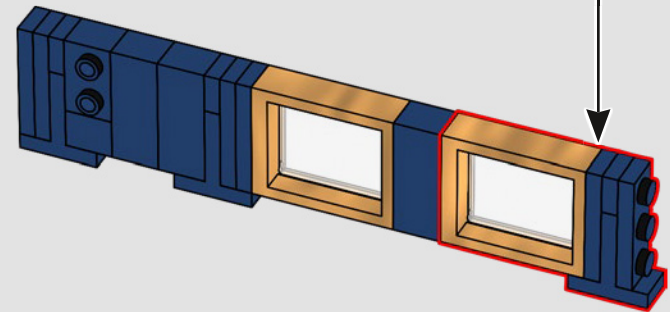
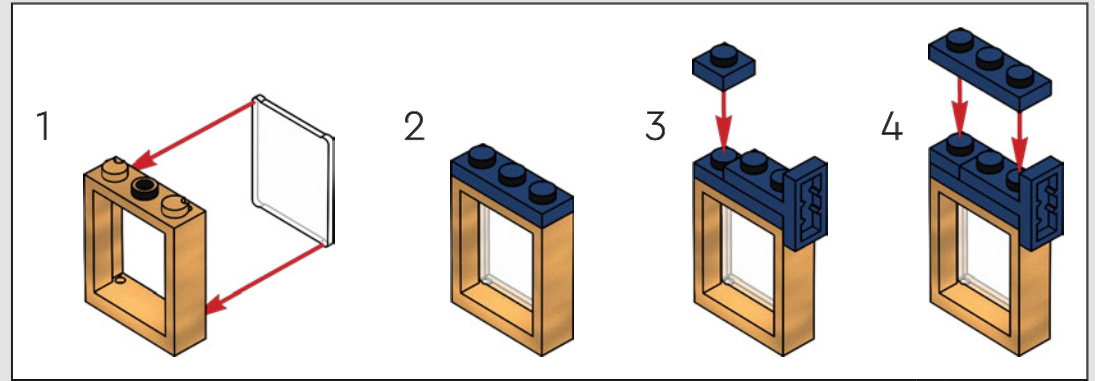

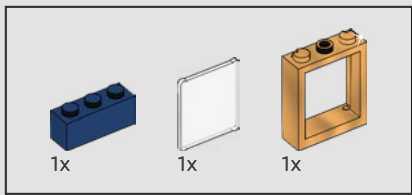

80

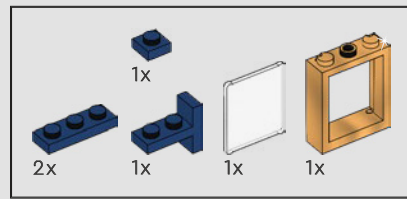
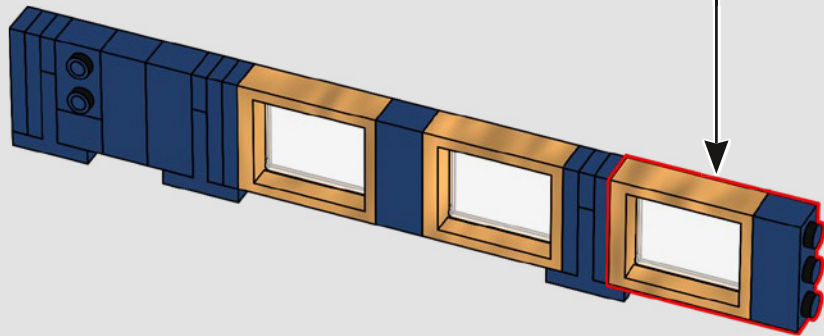
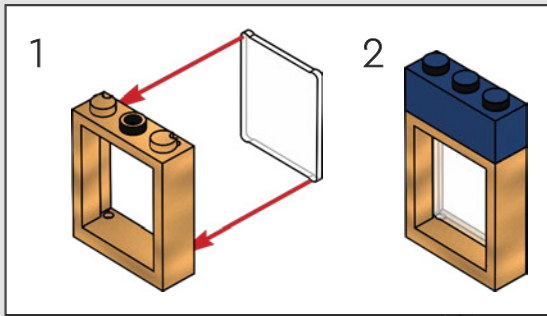

81

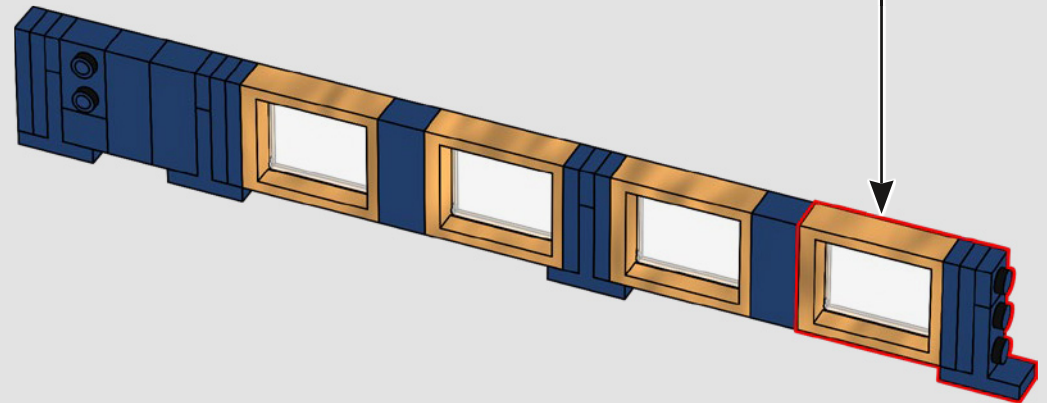
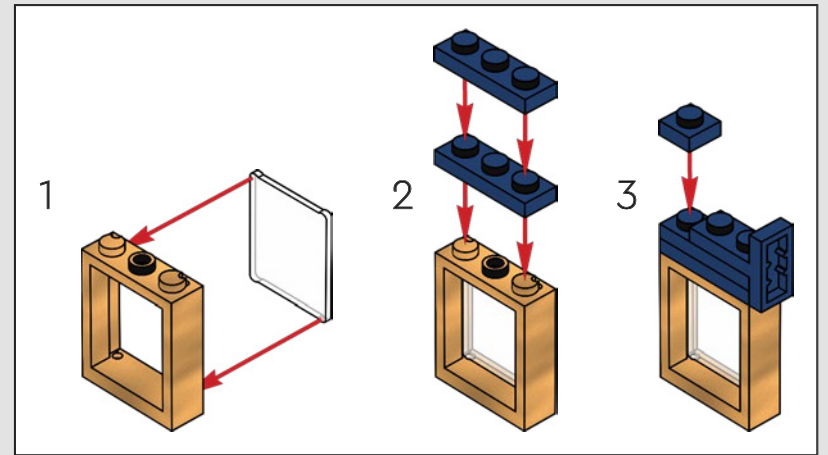

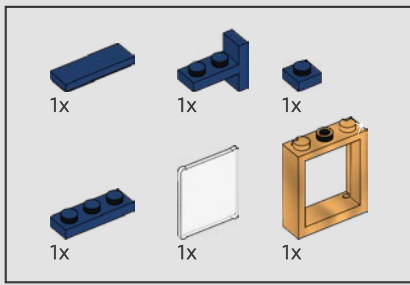

82

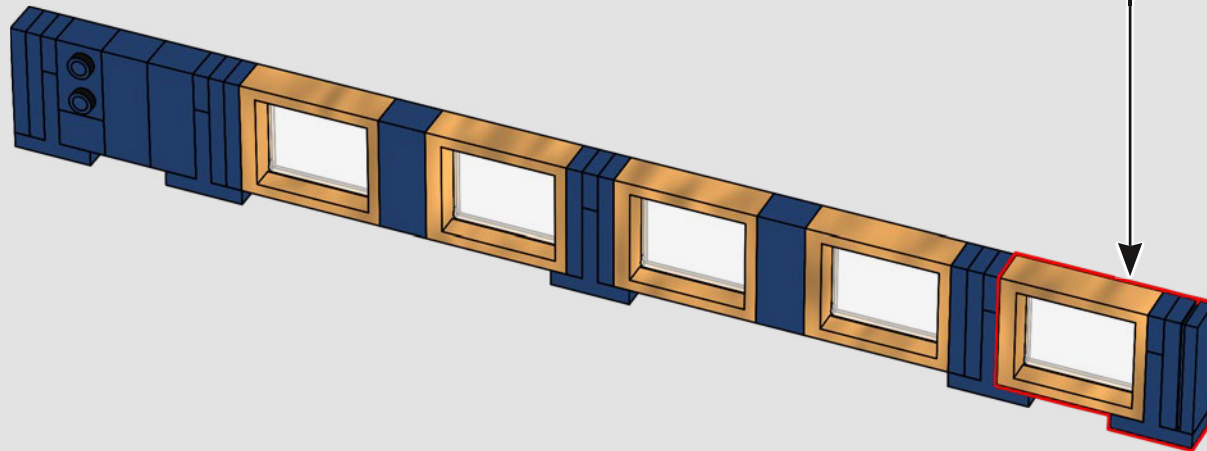
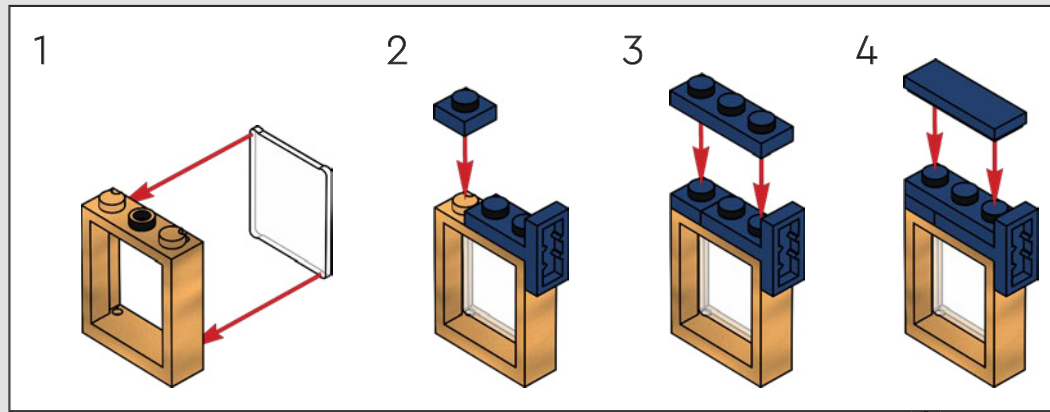

83

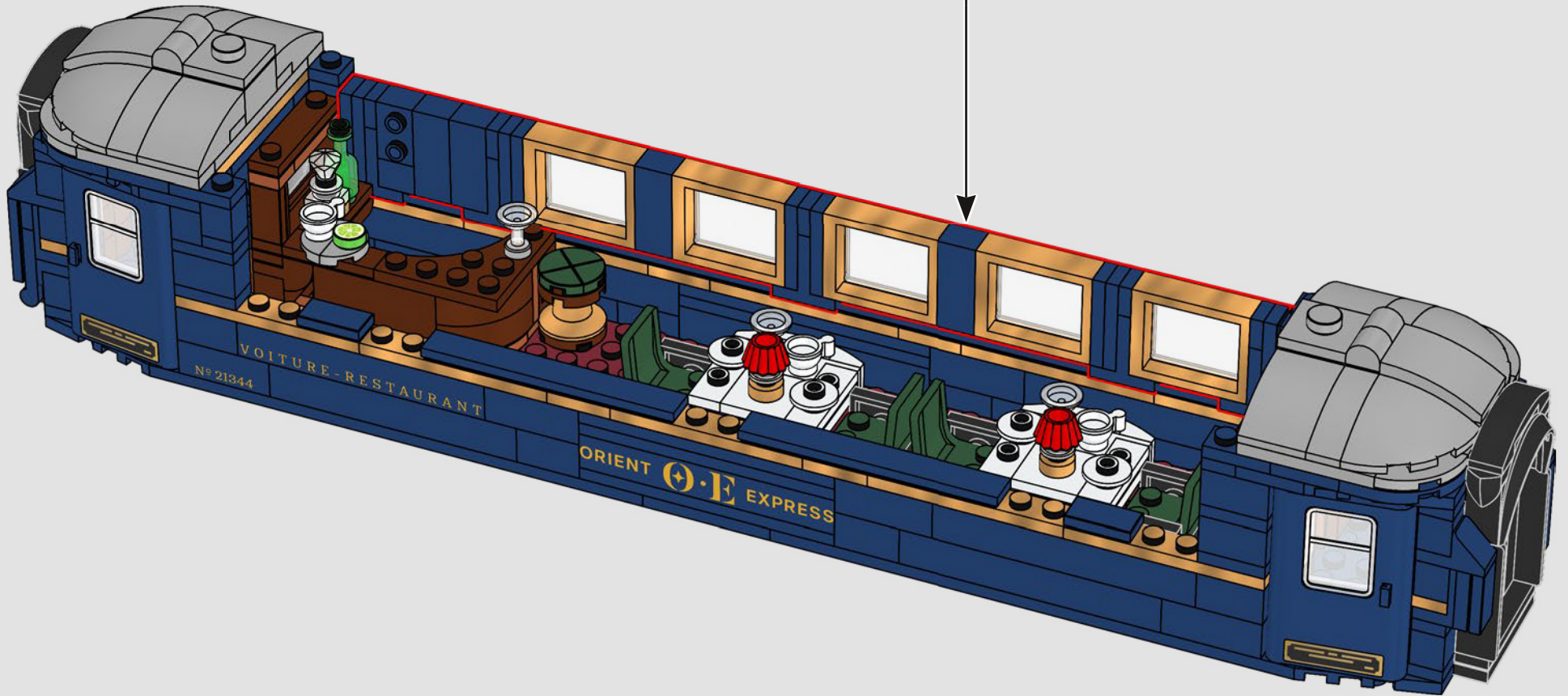

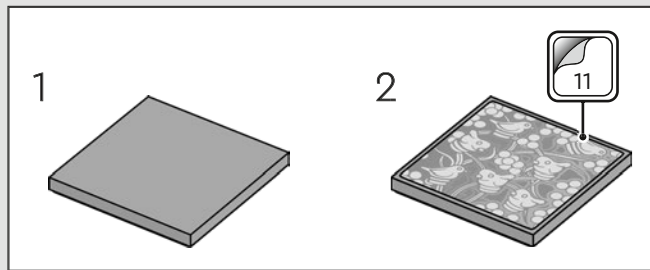
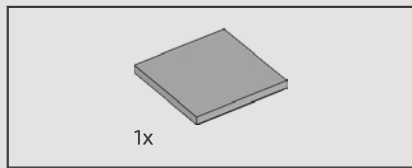

84

“这节车厢的内部装饰有精美的雕花玻璃镜。”

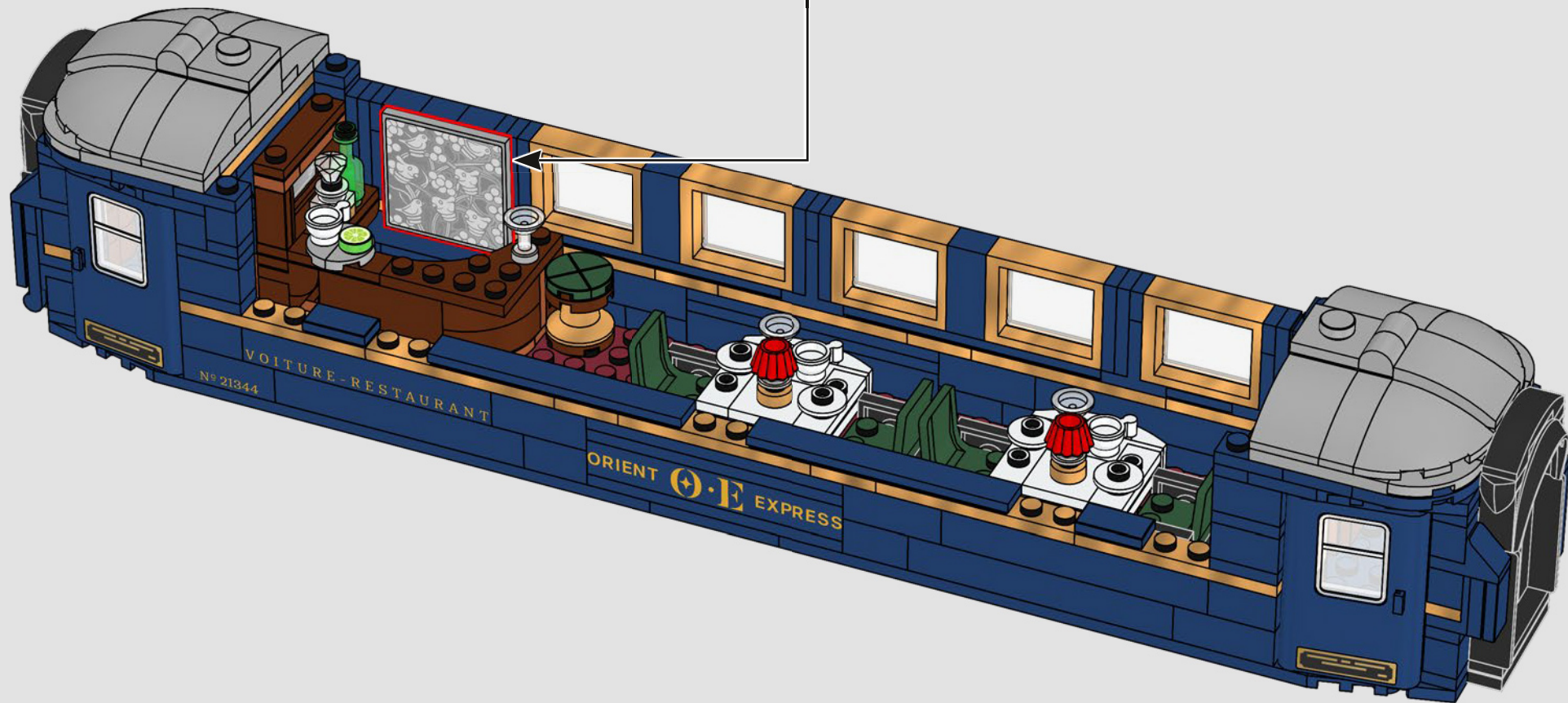

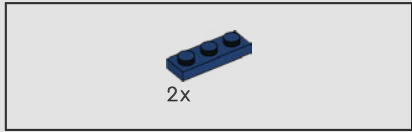
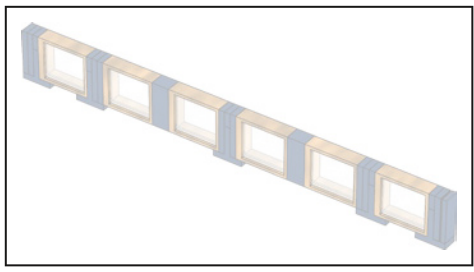

85

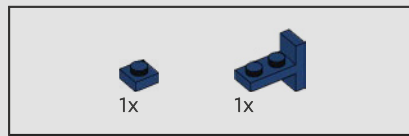
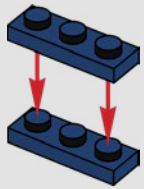

86

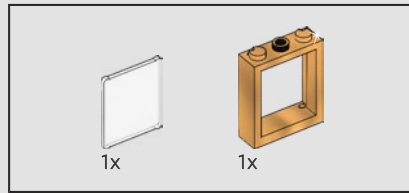
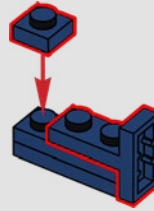

87

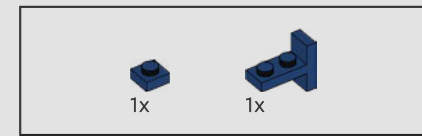
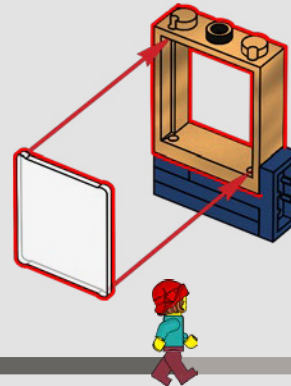

88

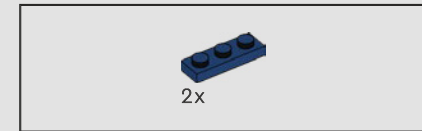
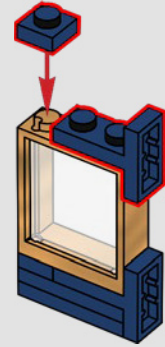

89

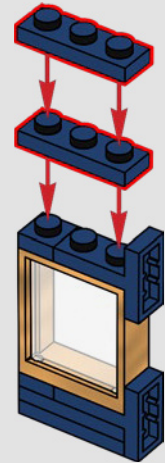

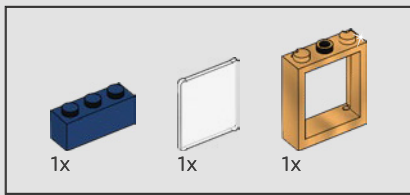

90

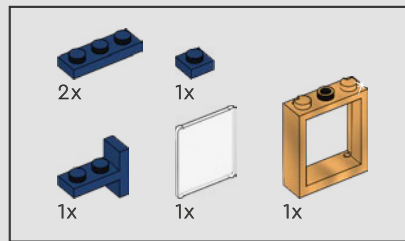
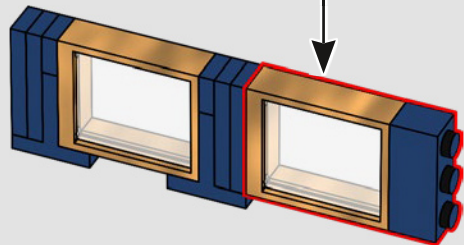
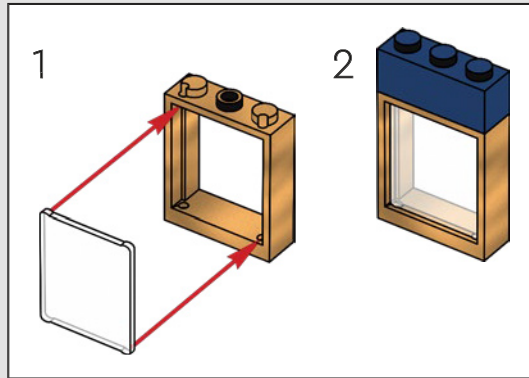

91

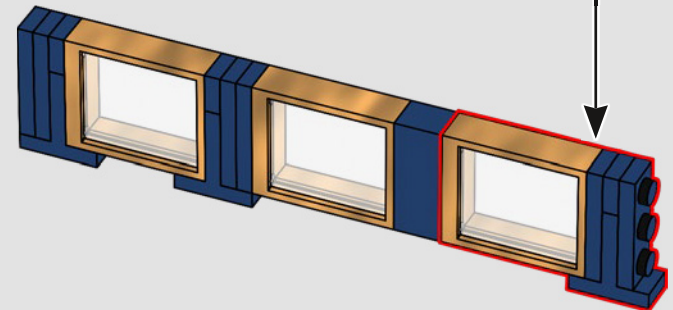
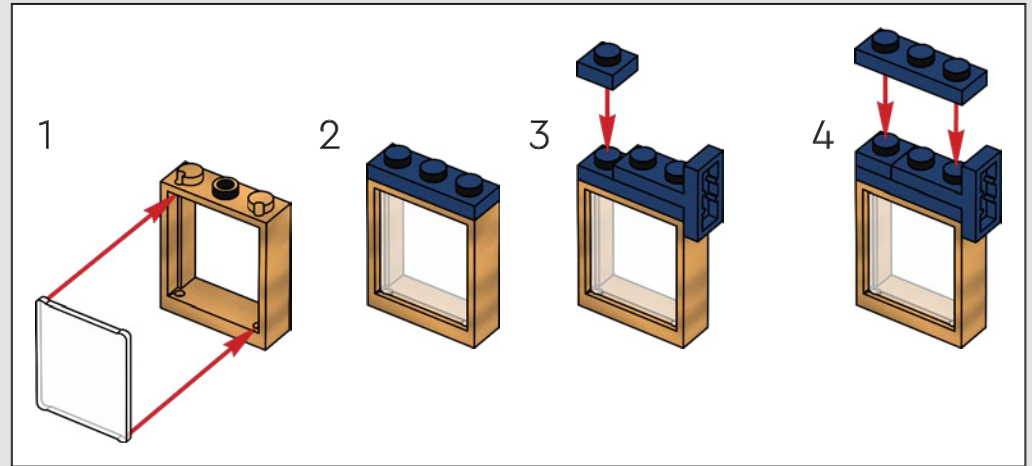

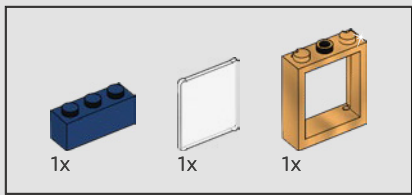

92

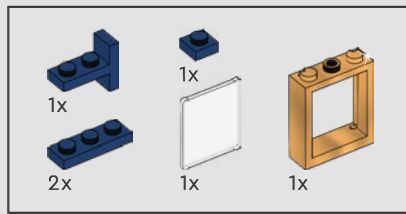
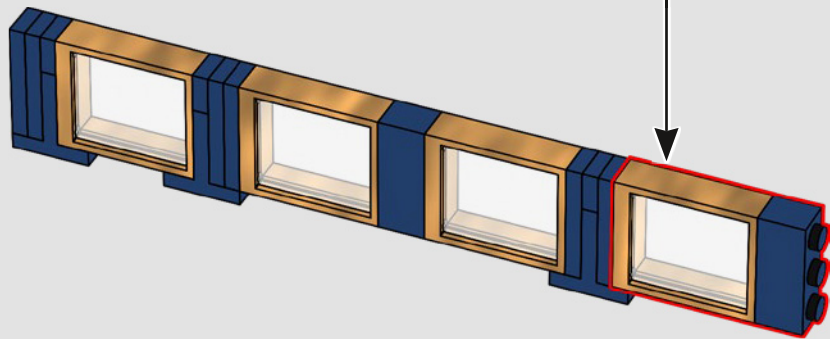
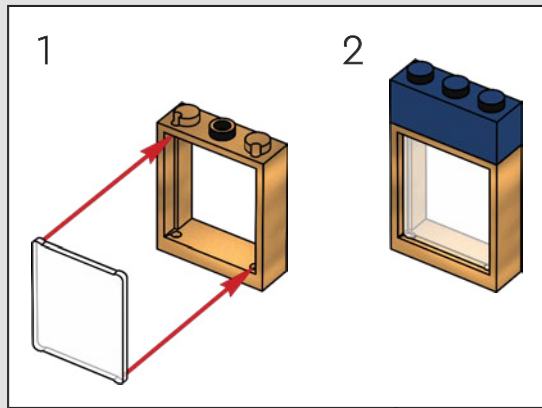

93

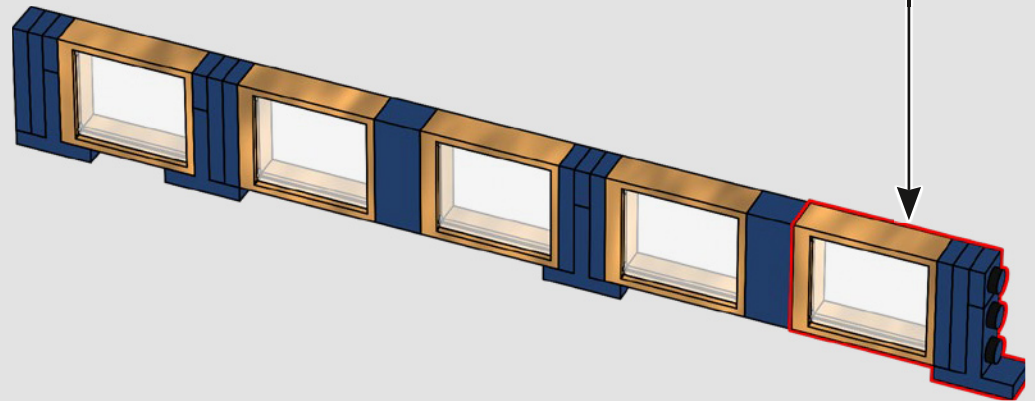
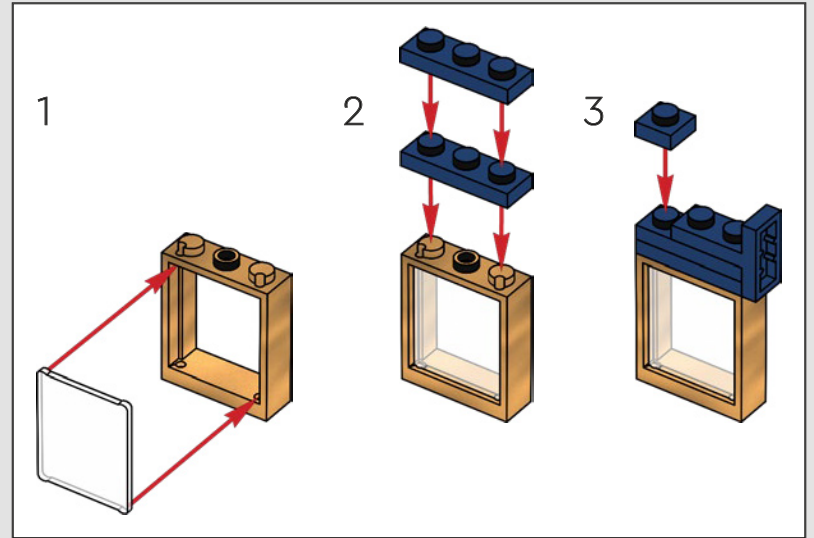

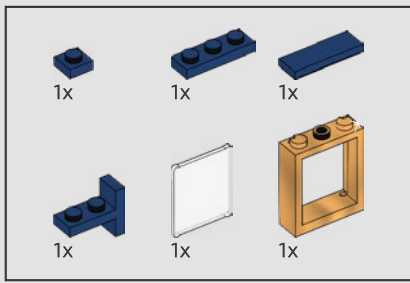

94

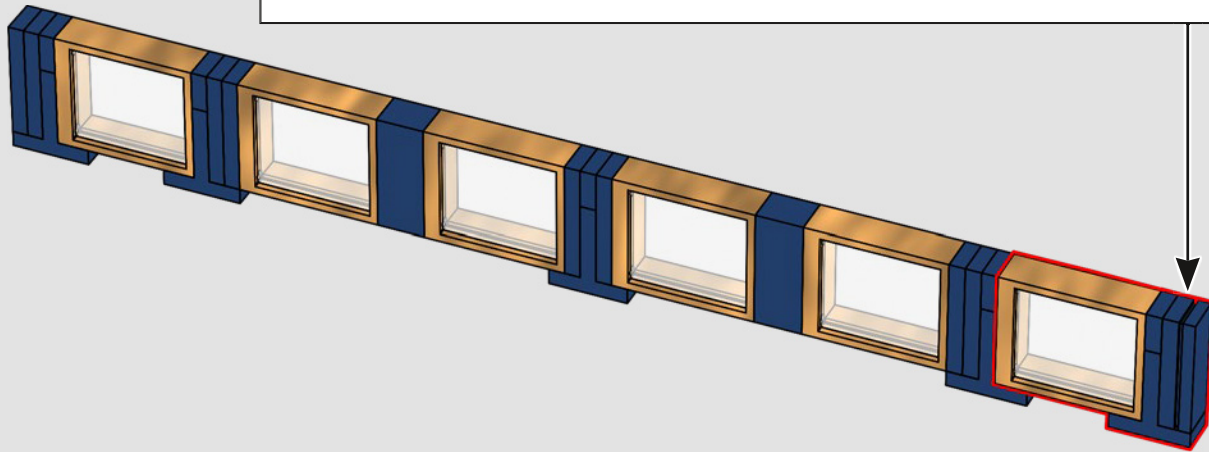
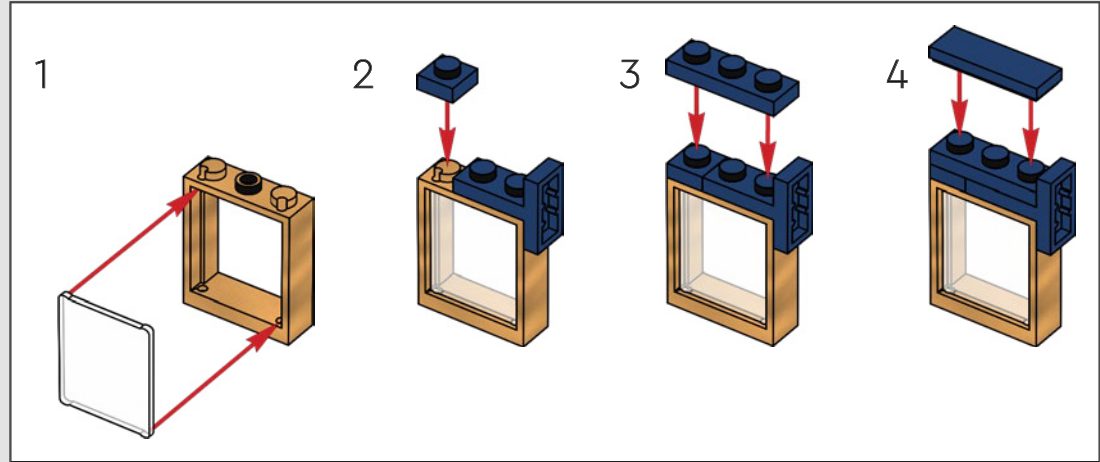



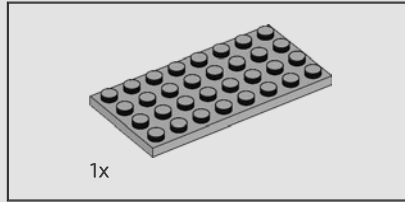
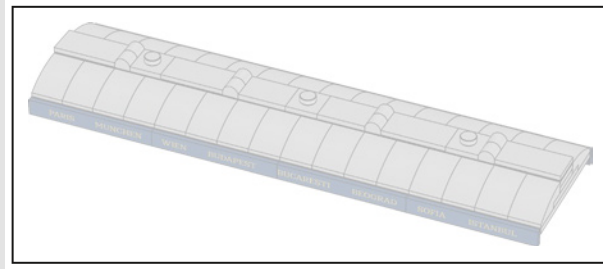

96

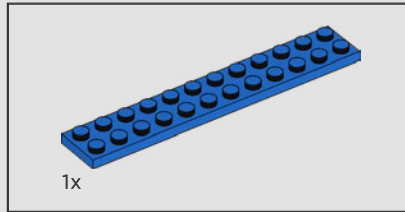
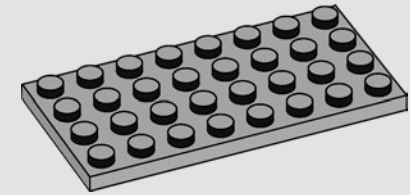

97

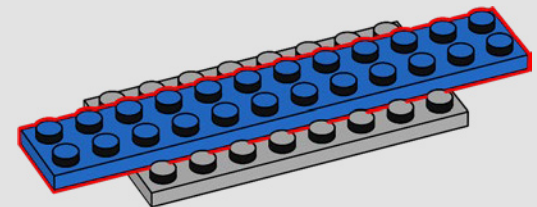

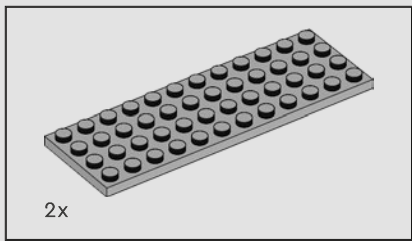

98

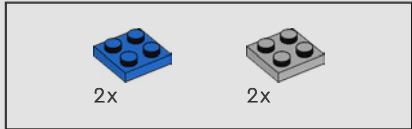
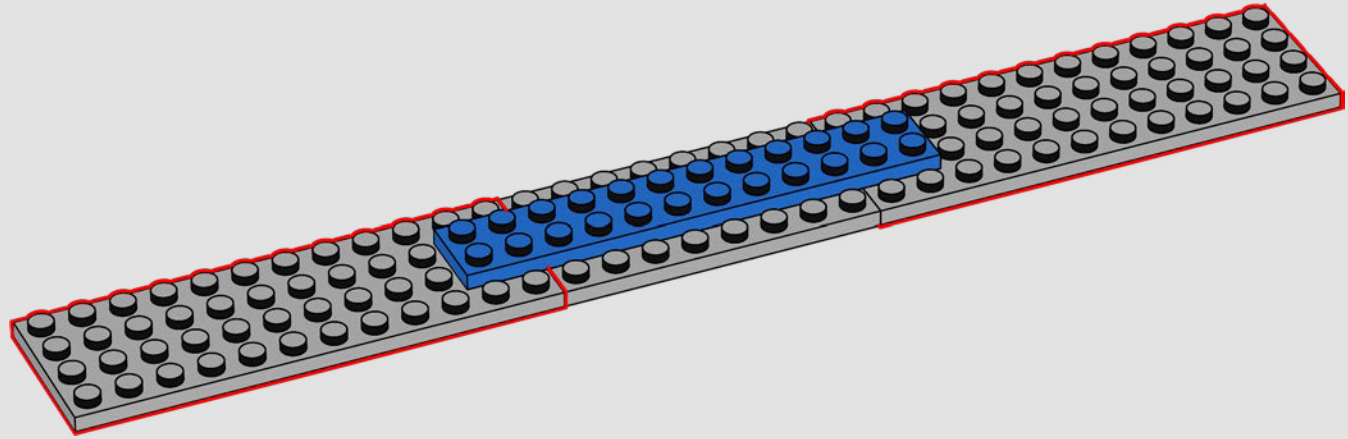

99

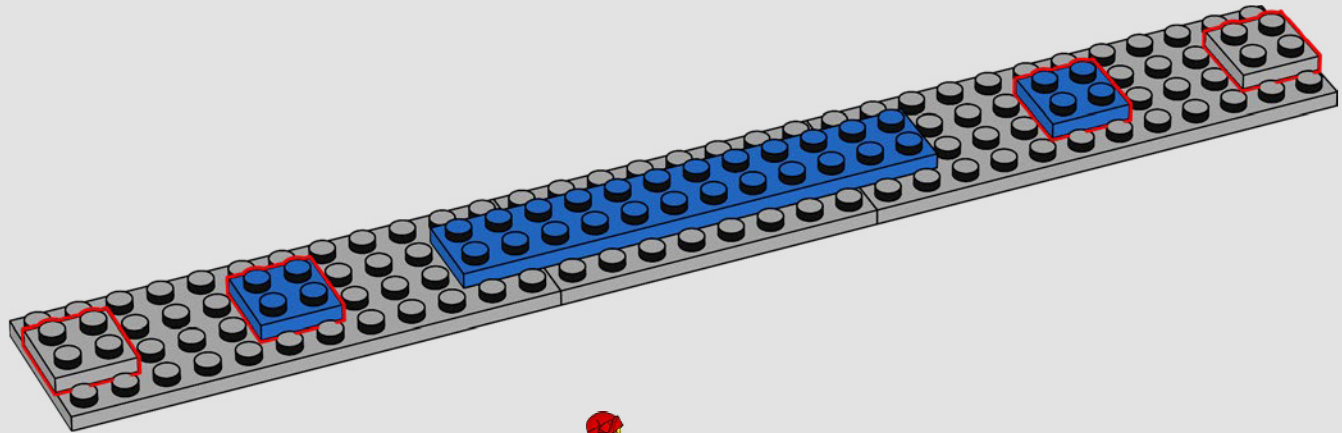

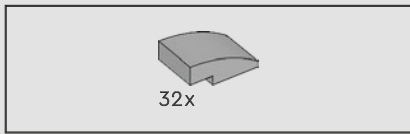

100

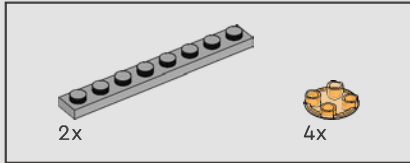
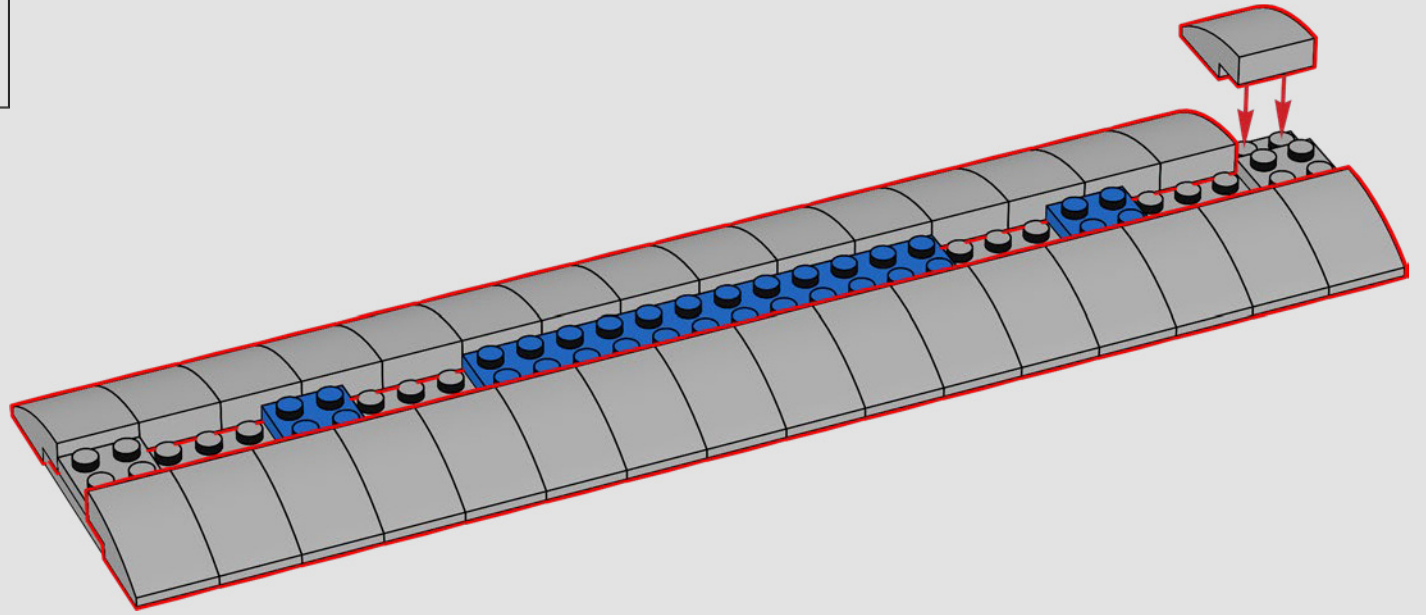

101

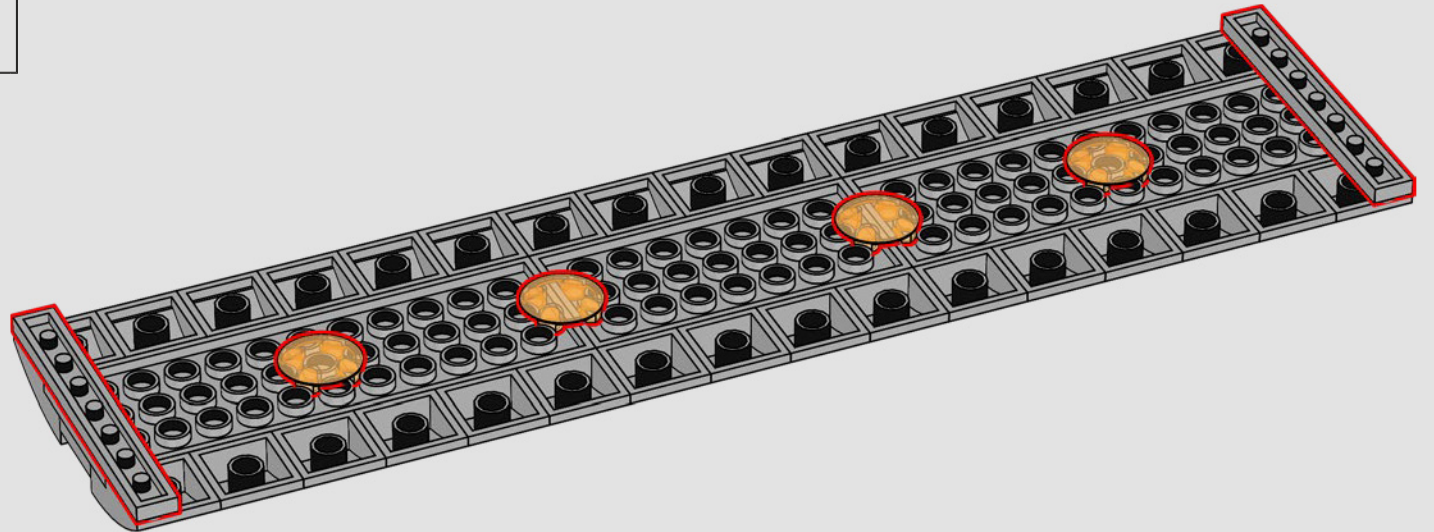

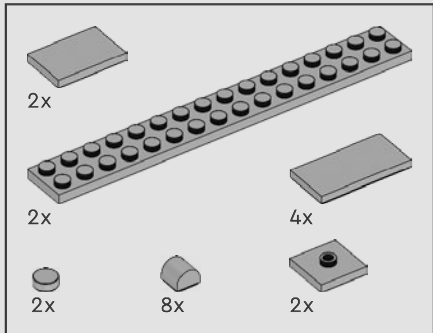
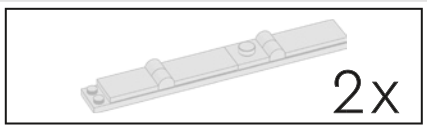

102

1

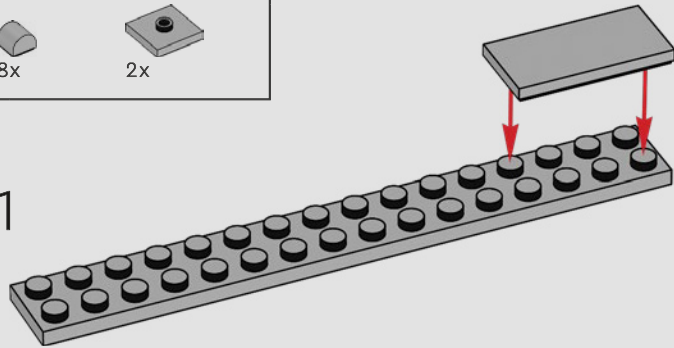

2

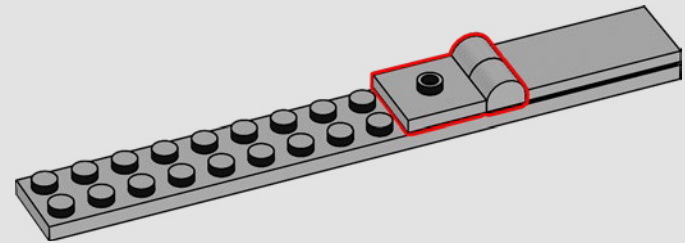

3

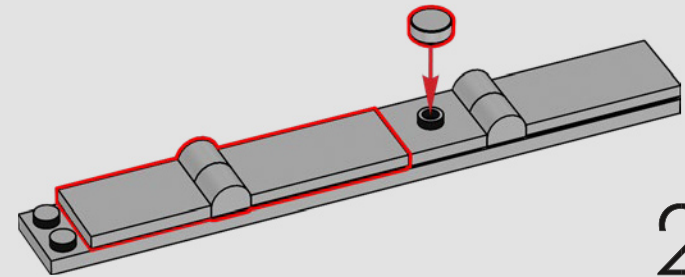

2x

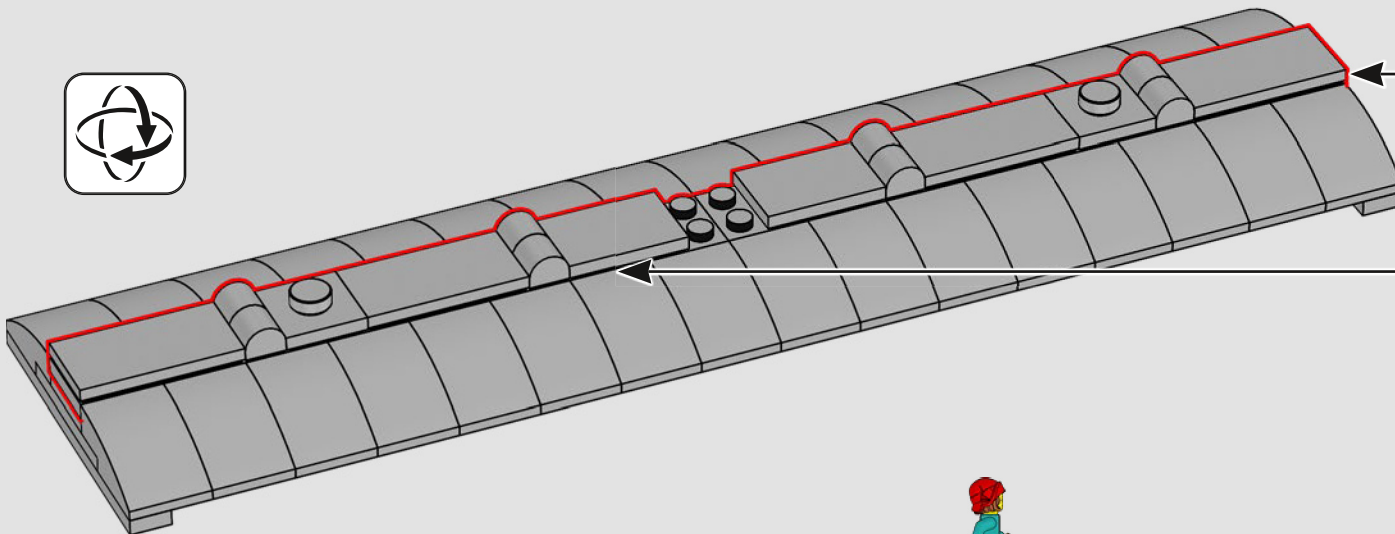

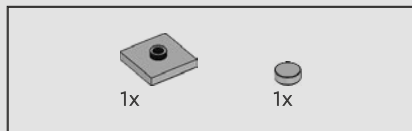

103

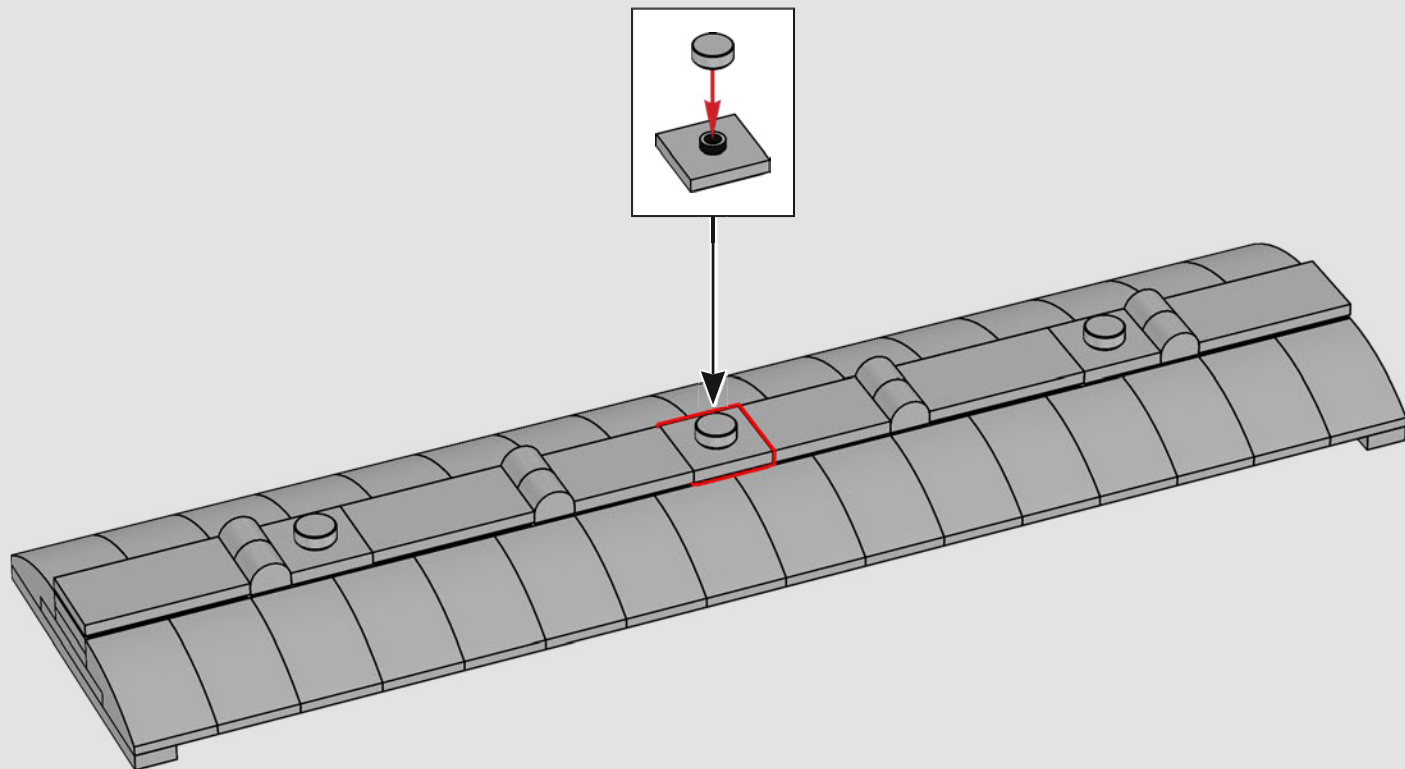

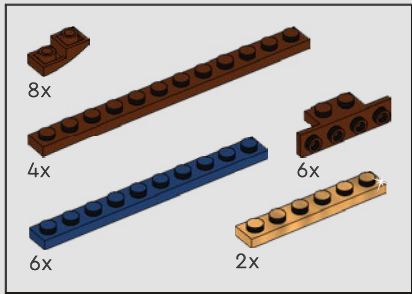
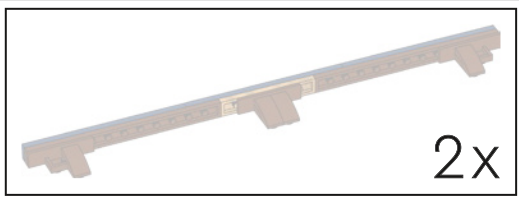

104

1

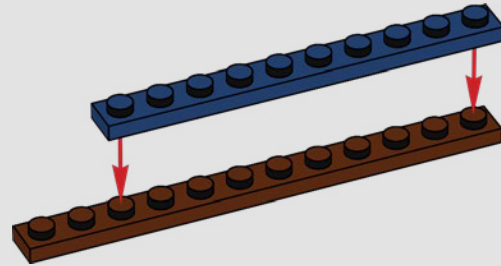

2

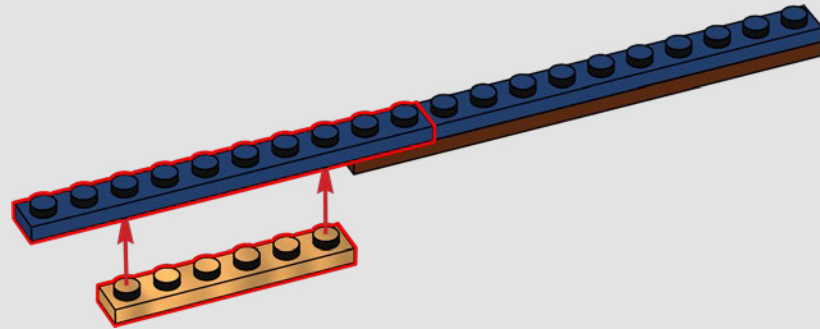

3

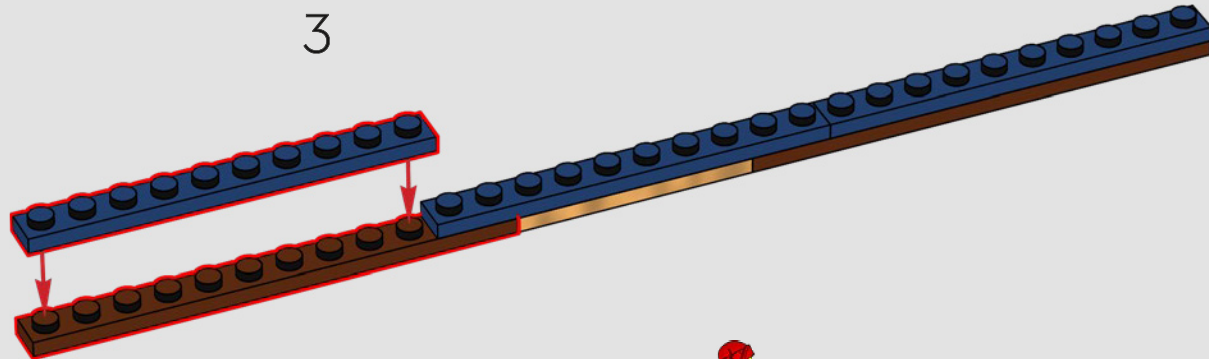

4

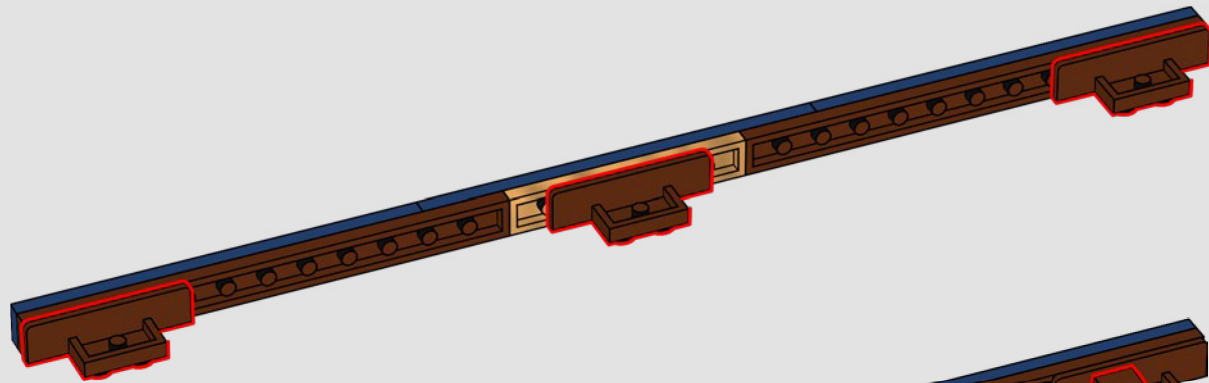

5

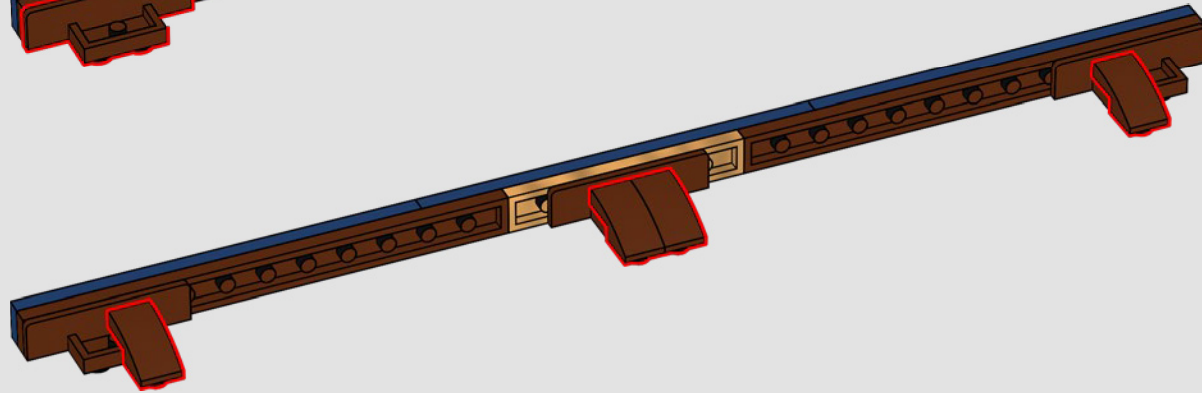

2x

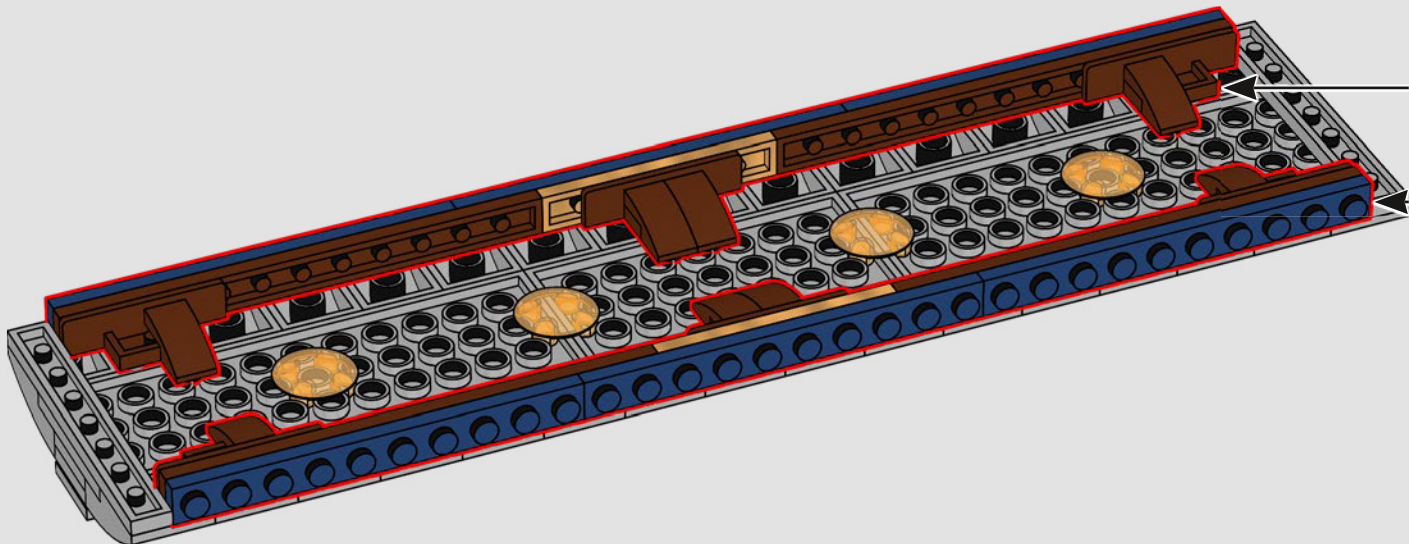

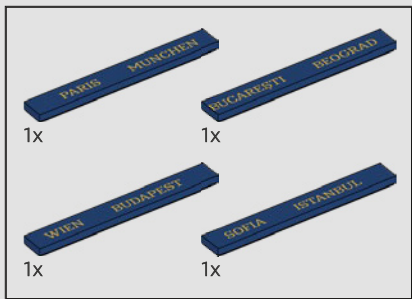

105

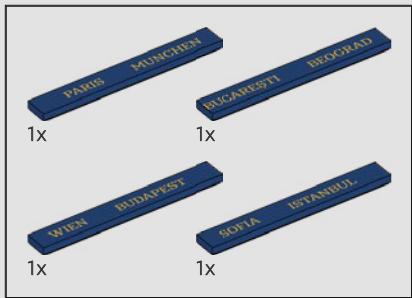
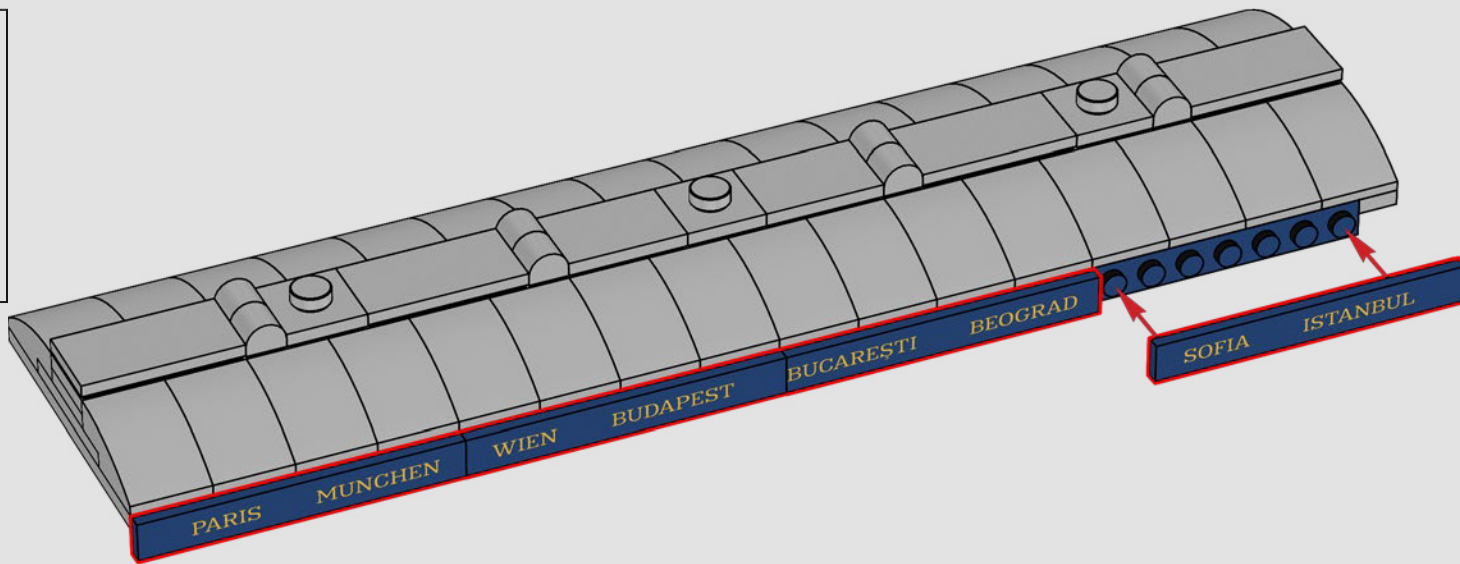

106

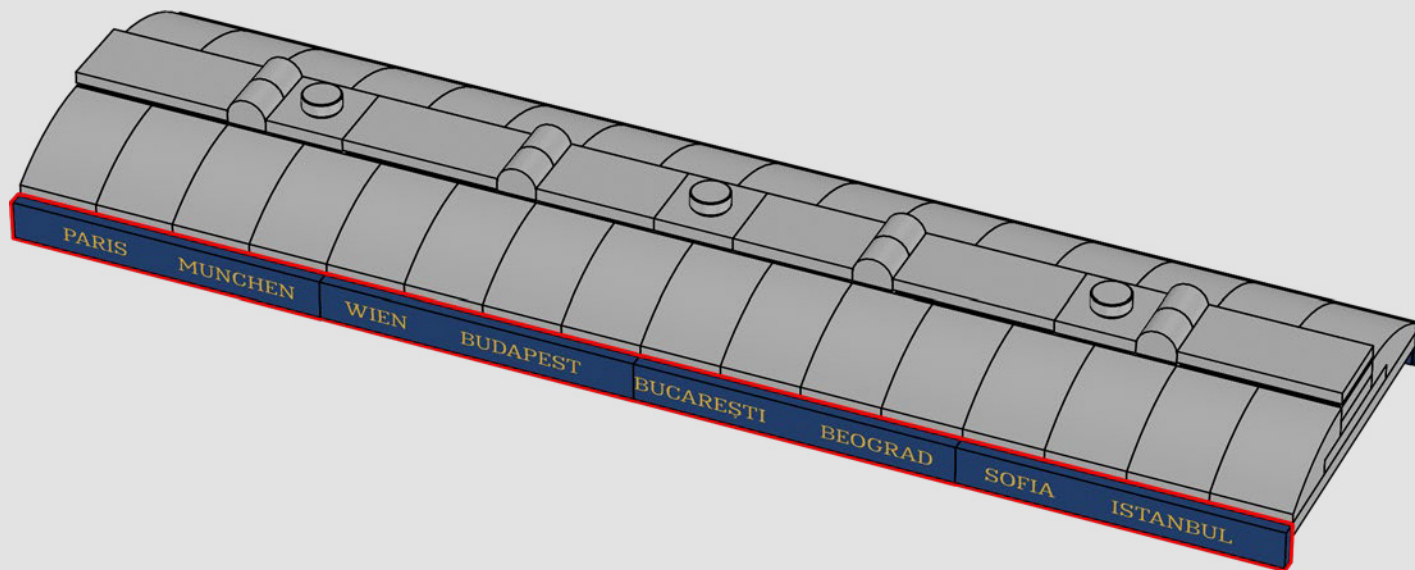

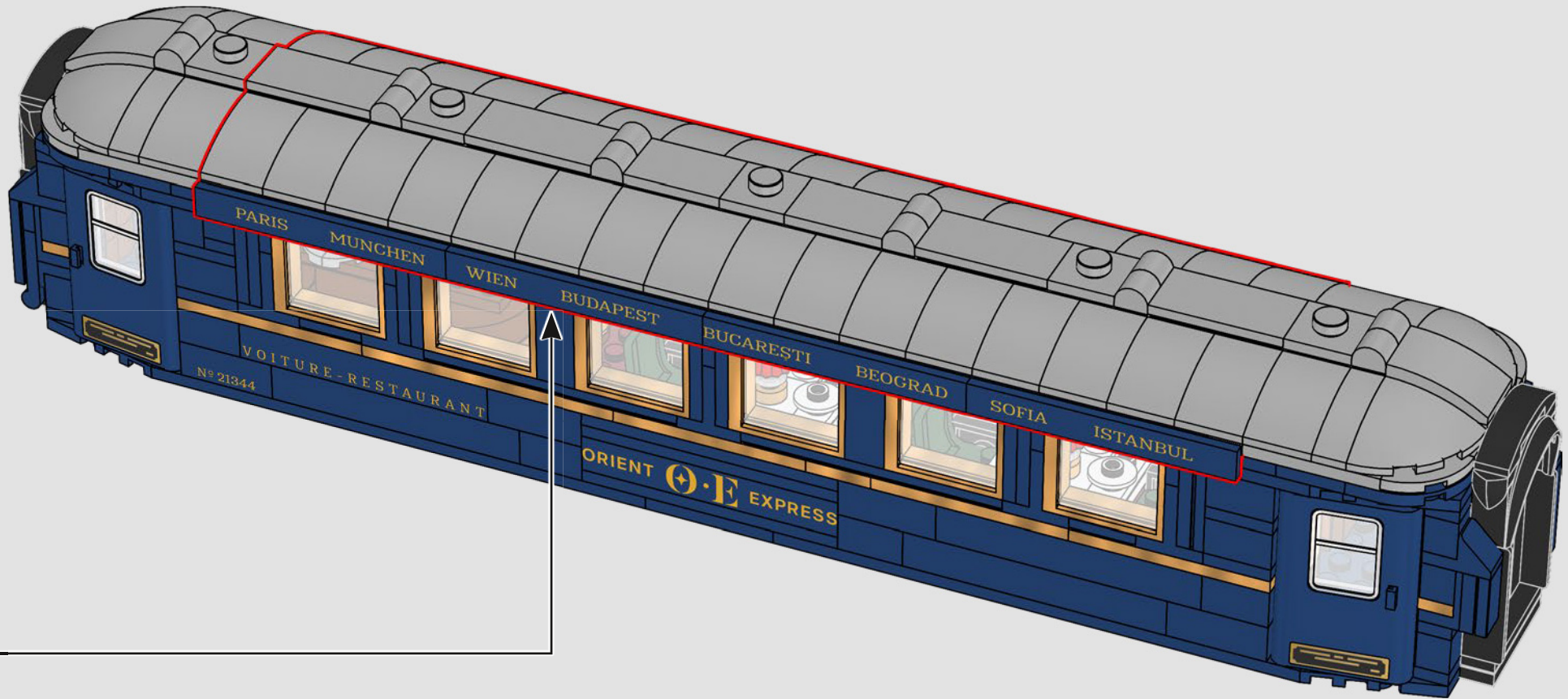

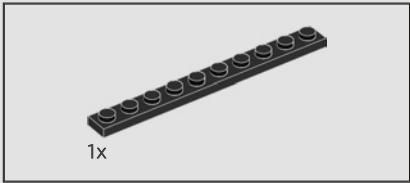
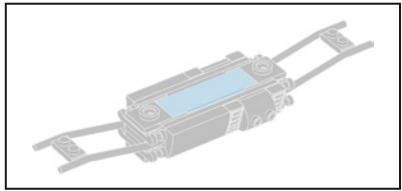

108

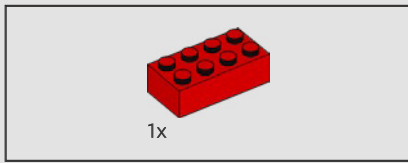
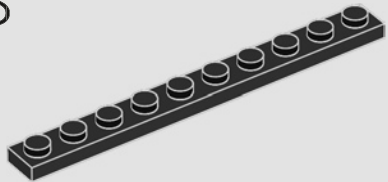

109

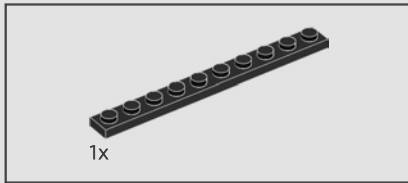
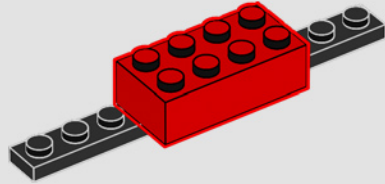

110

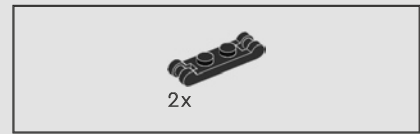
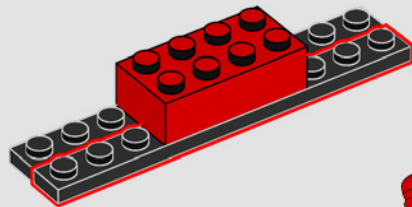

111

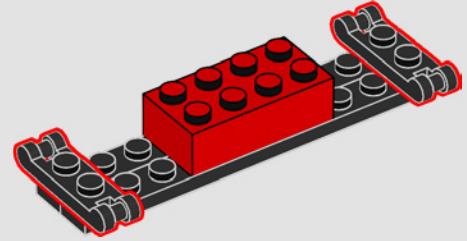

112

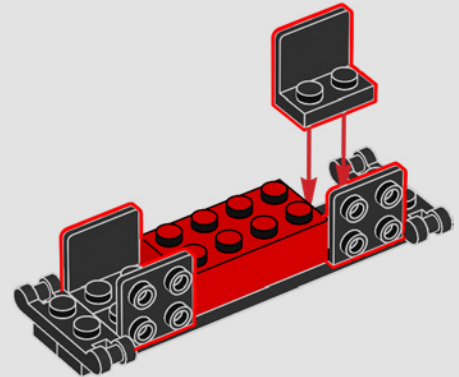

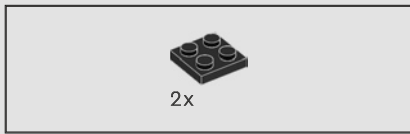

113

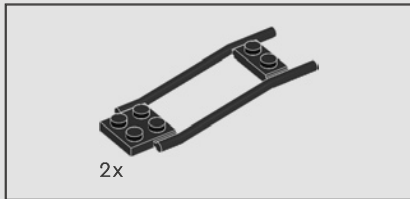
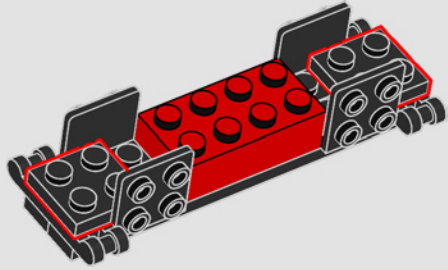

114

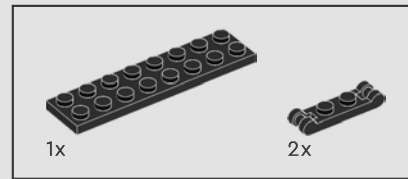
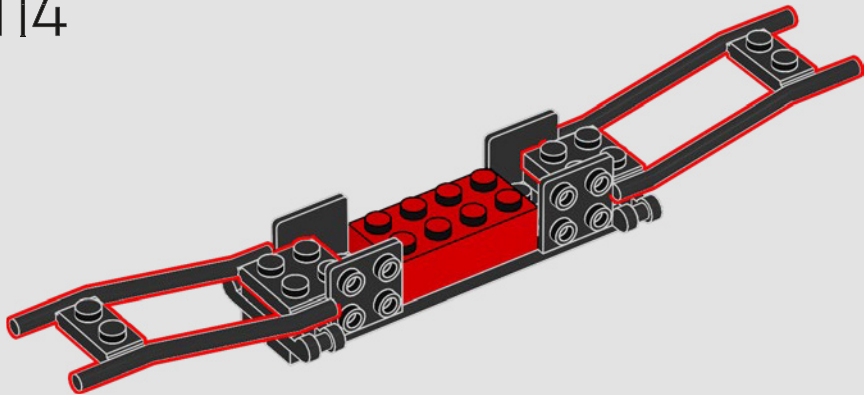

115

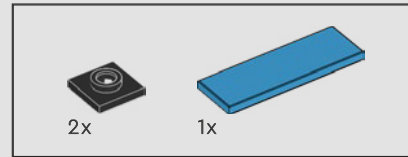
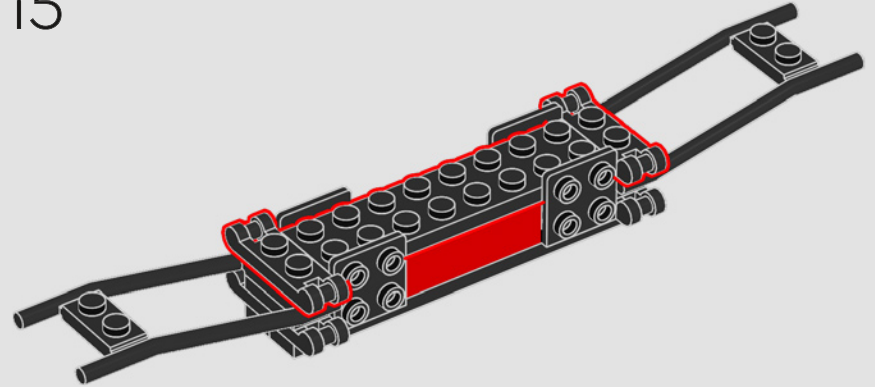

116

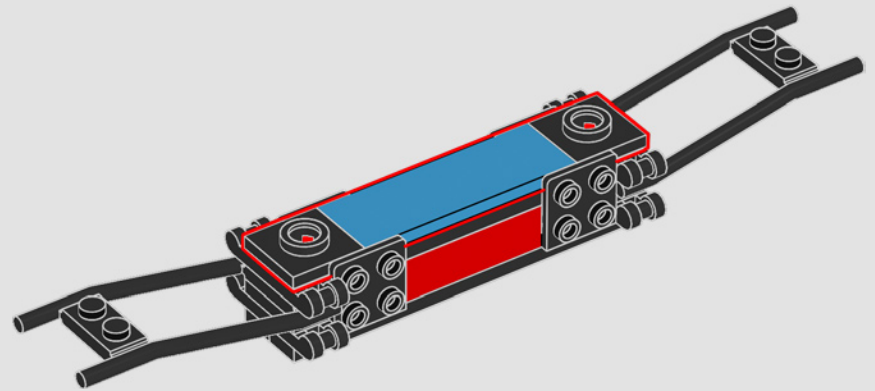

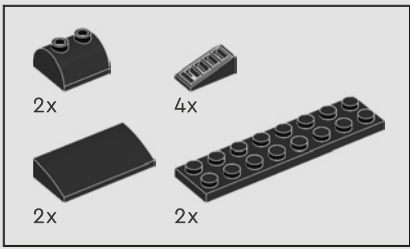

117

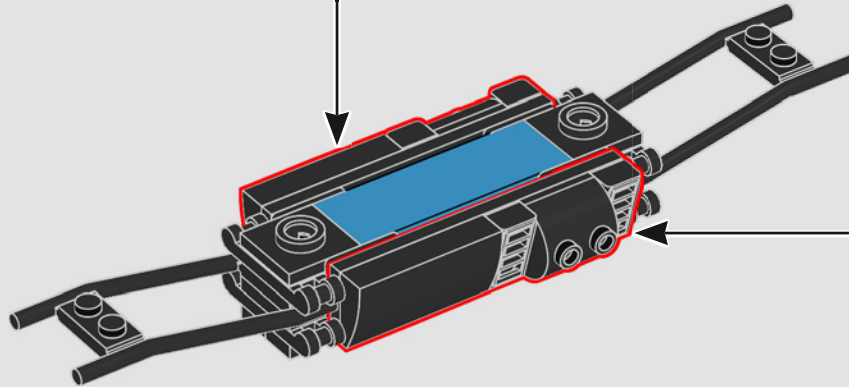
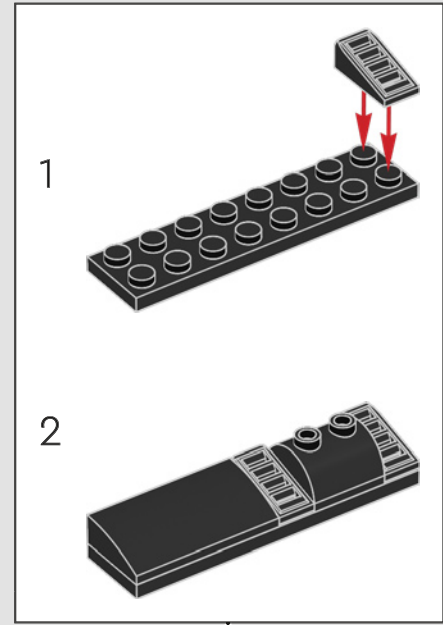
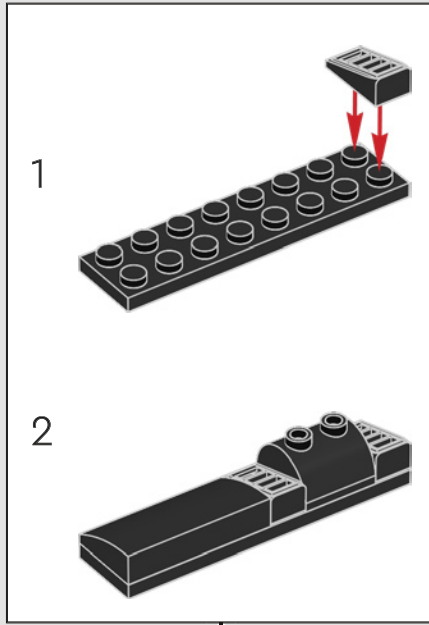

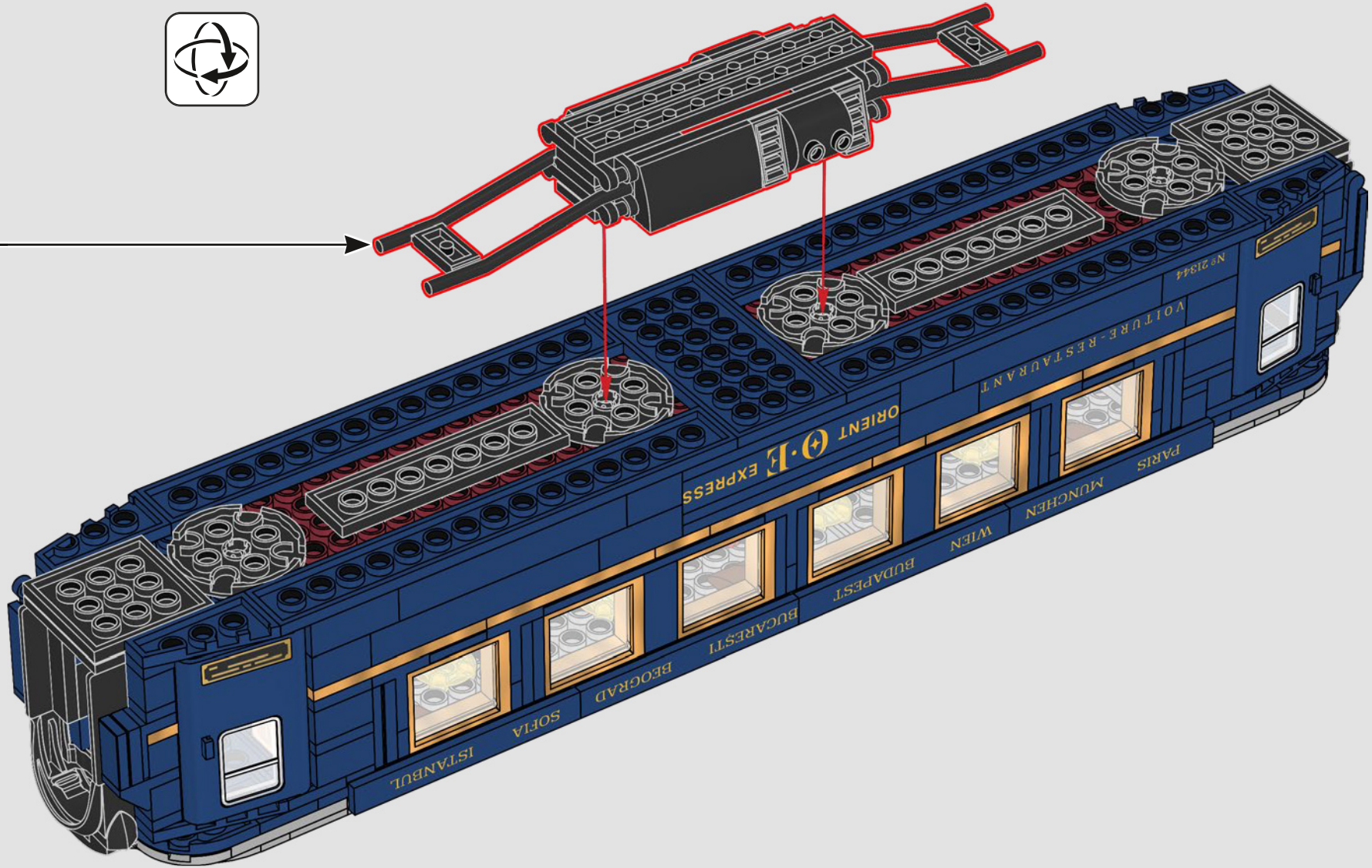

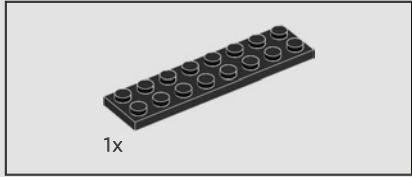
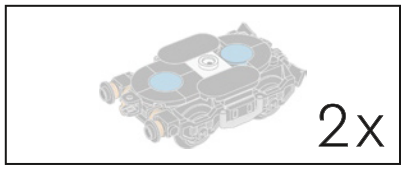

119

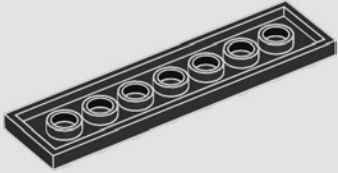

120

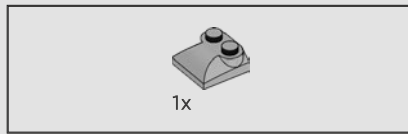
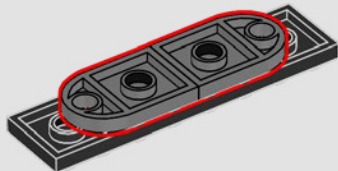

121

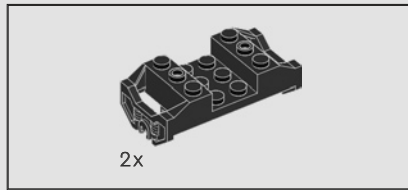
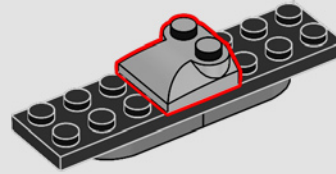

122

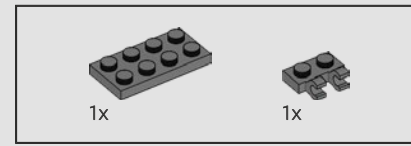
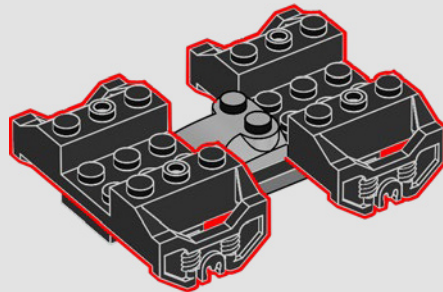

123

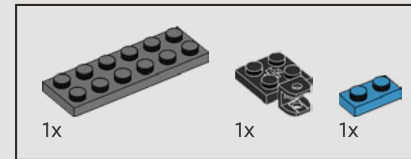
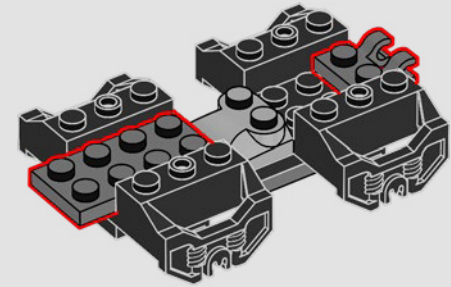

124

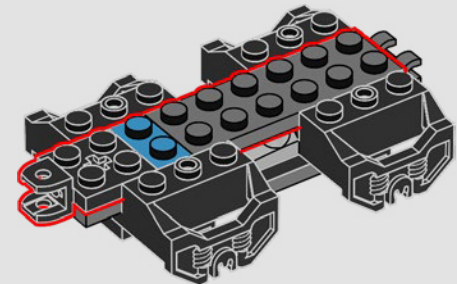

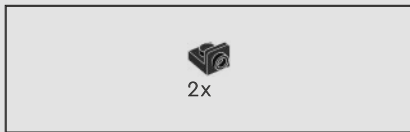

125

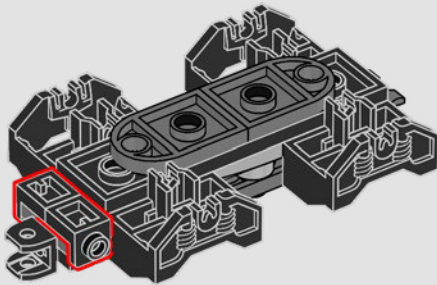

126

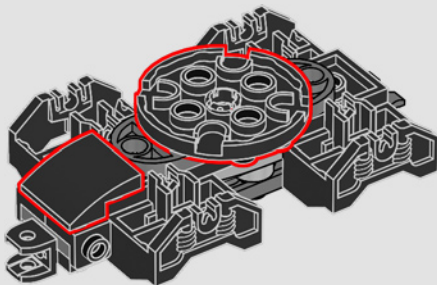

127

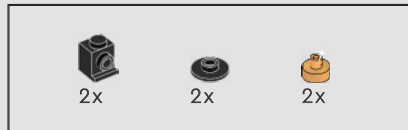
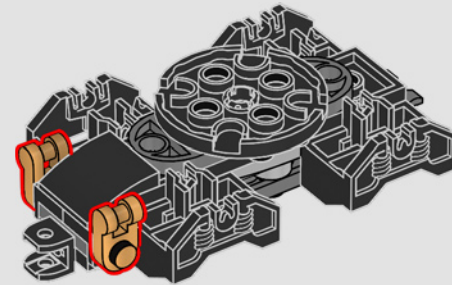

128

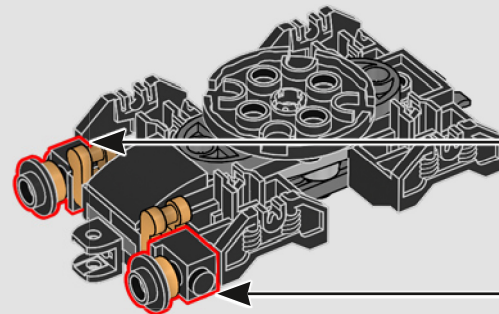
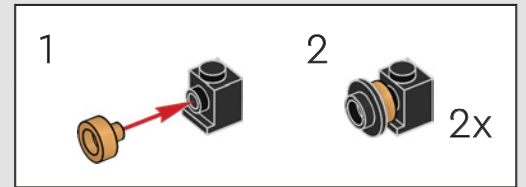

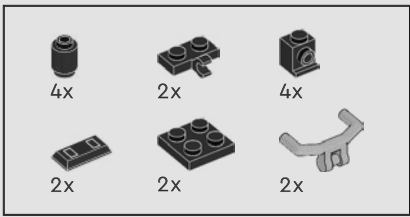

129

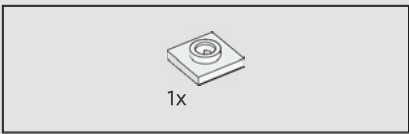
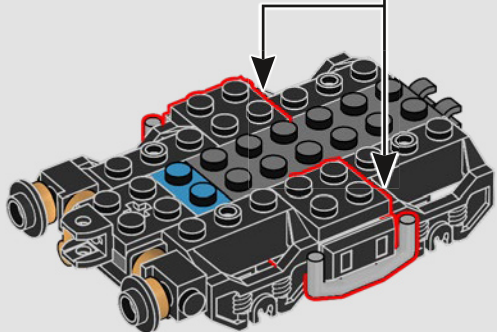
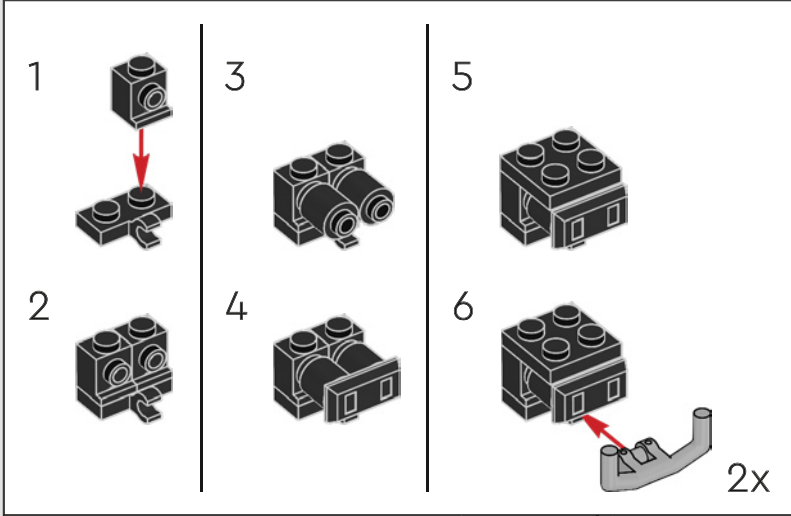

130

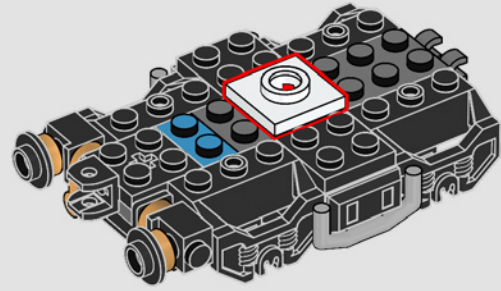

131

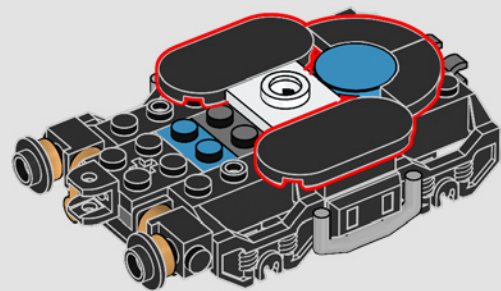



132

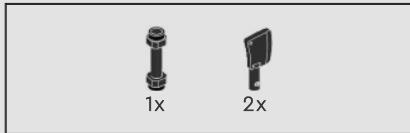
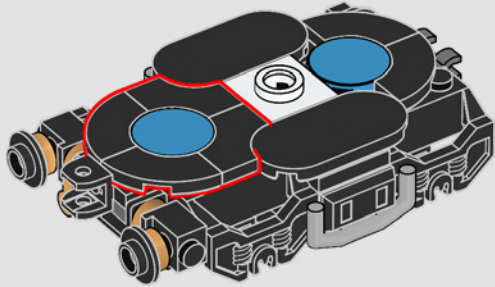

133

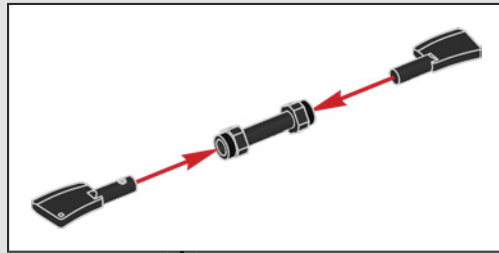
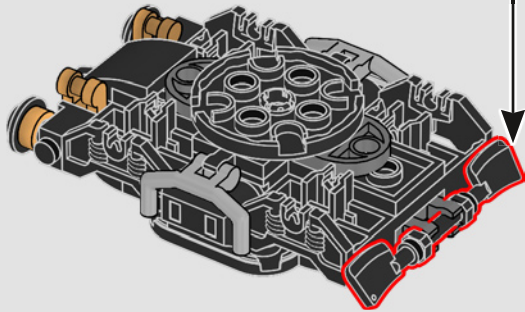

134

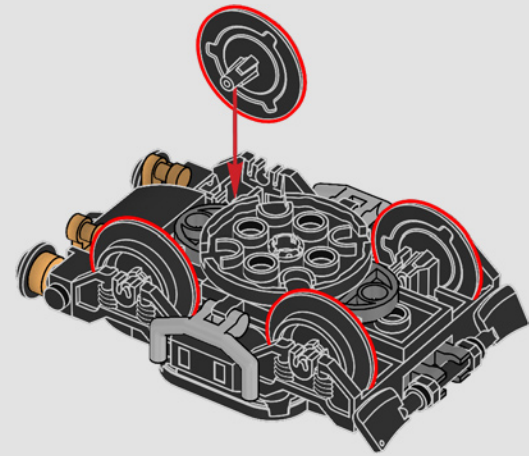

2x

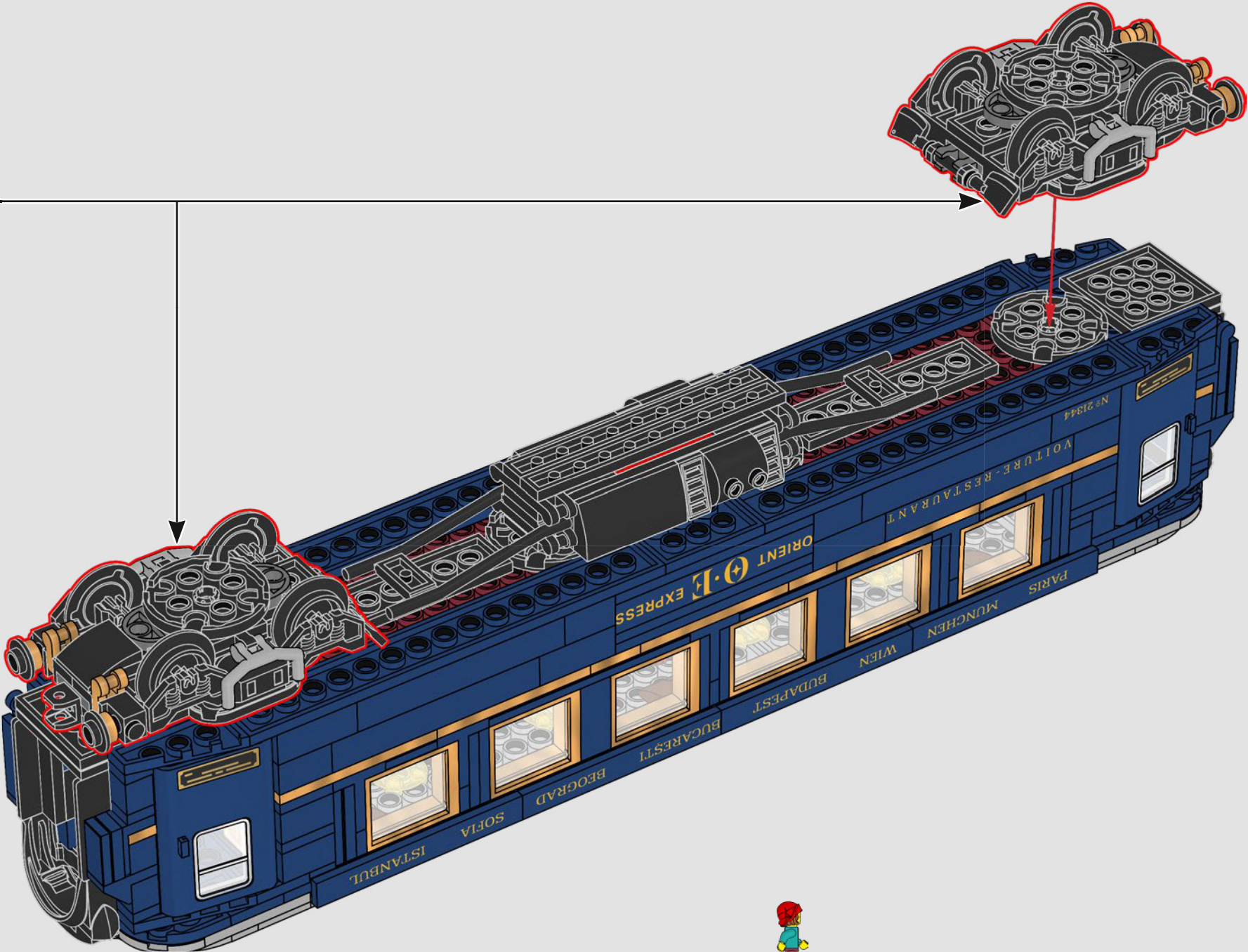

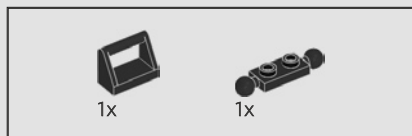

●
下一站: 维也纳
“美妙的晚餐之后, 是时候到卧铺车厢了。”

136

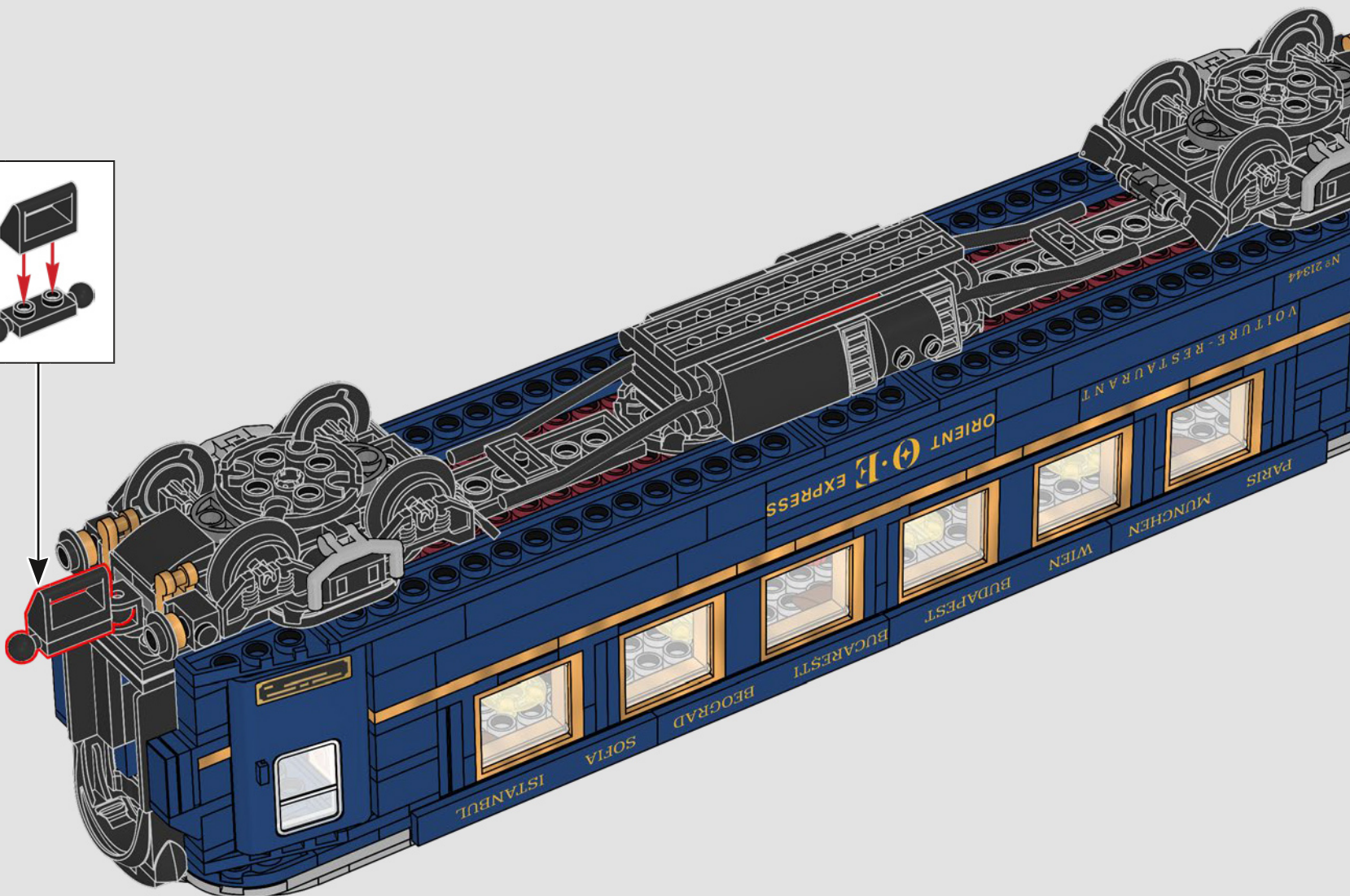
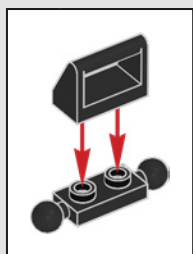

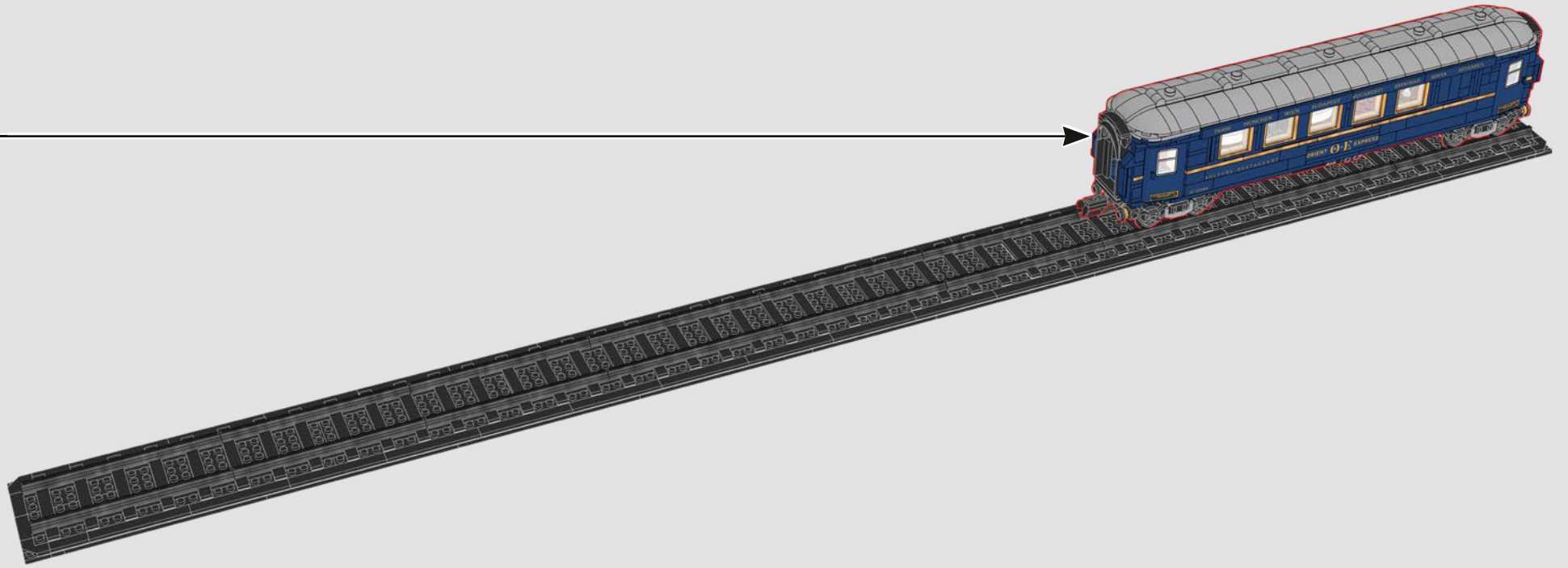

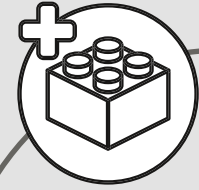
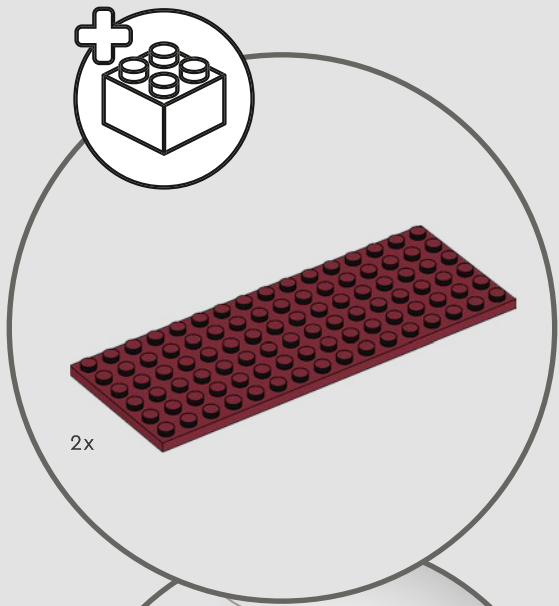

2x

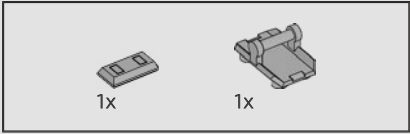
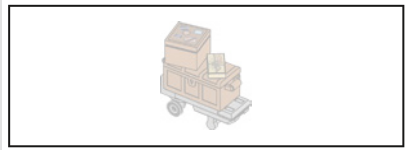

1

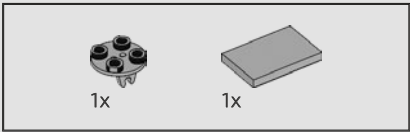
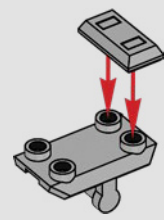

2

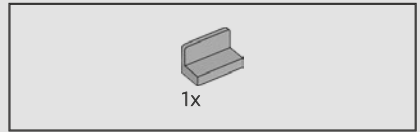

3

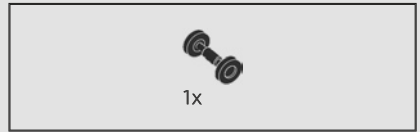
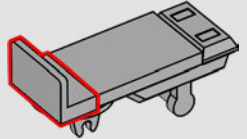

4

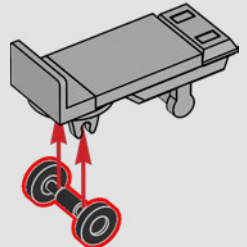

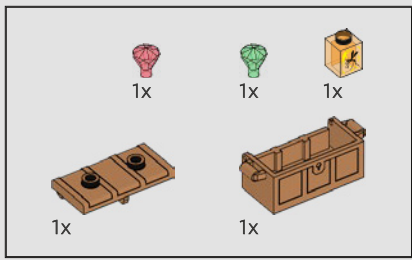

5

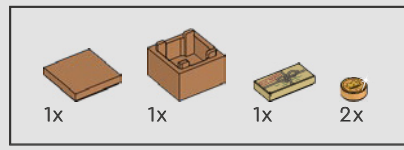
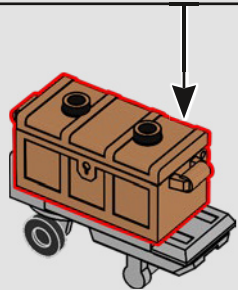
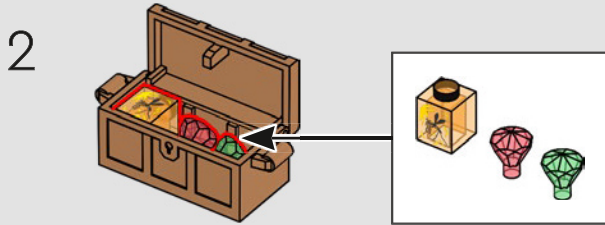
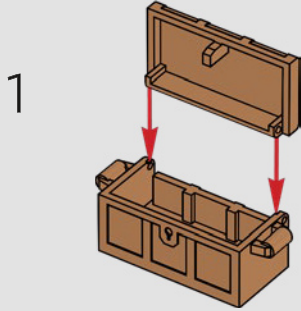

6

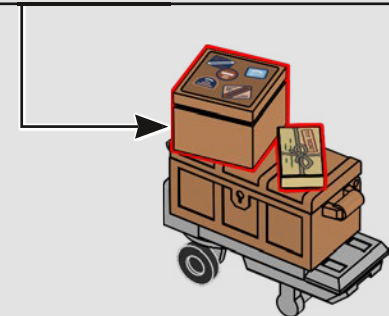
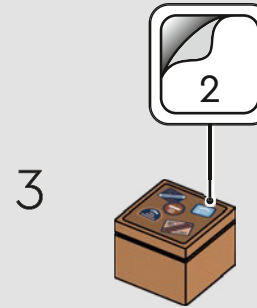
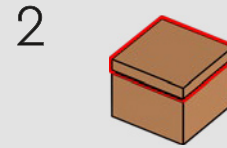
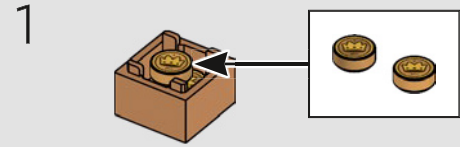

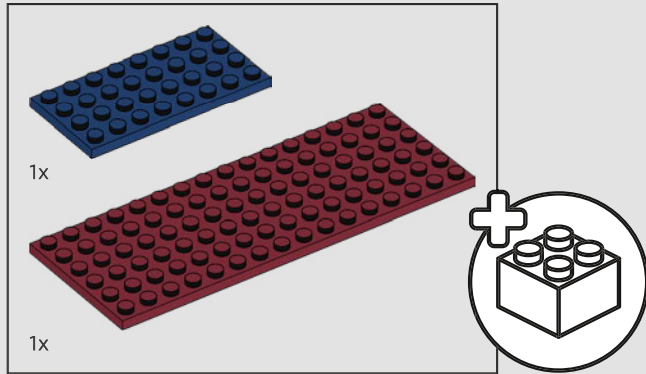
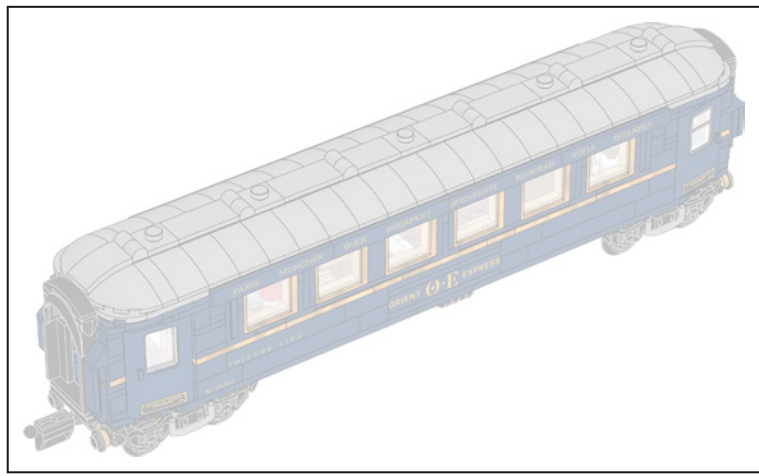

138

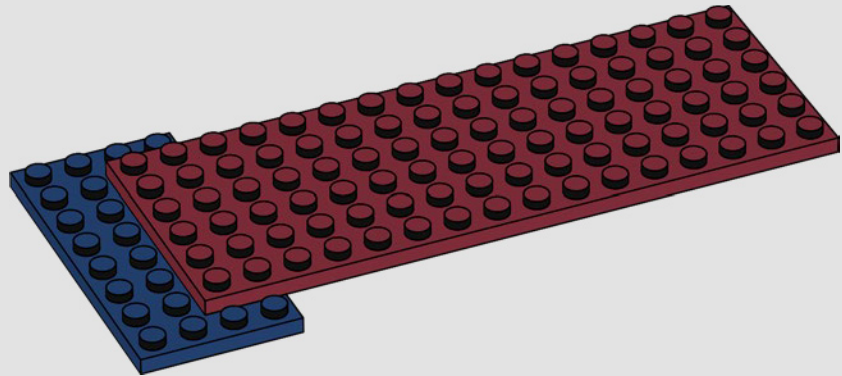

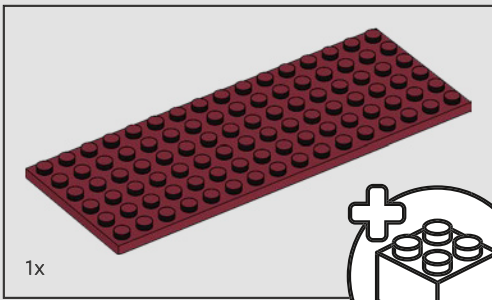

1x

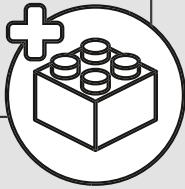

139

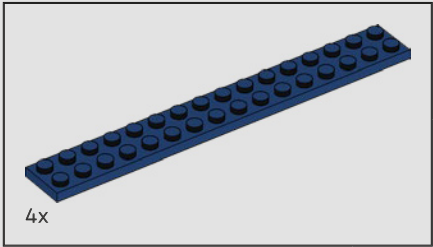
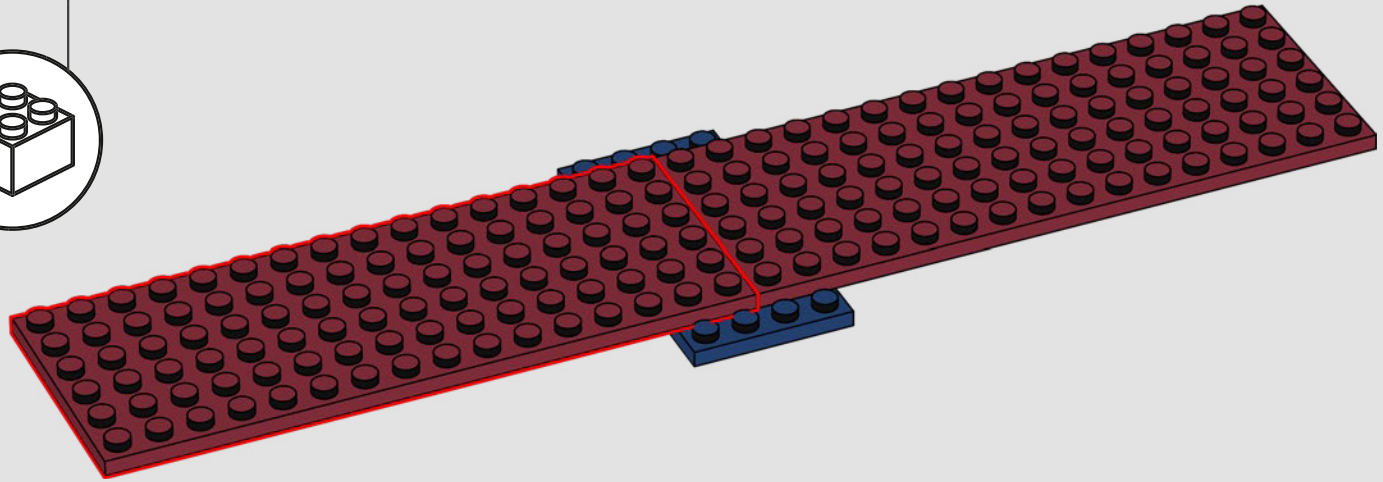

4x

140

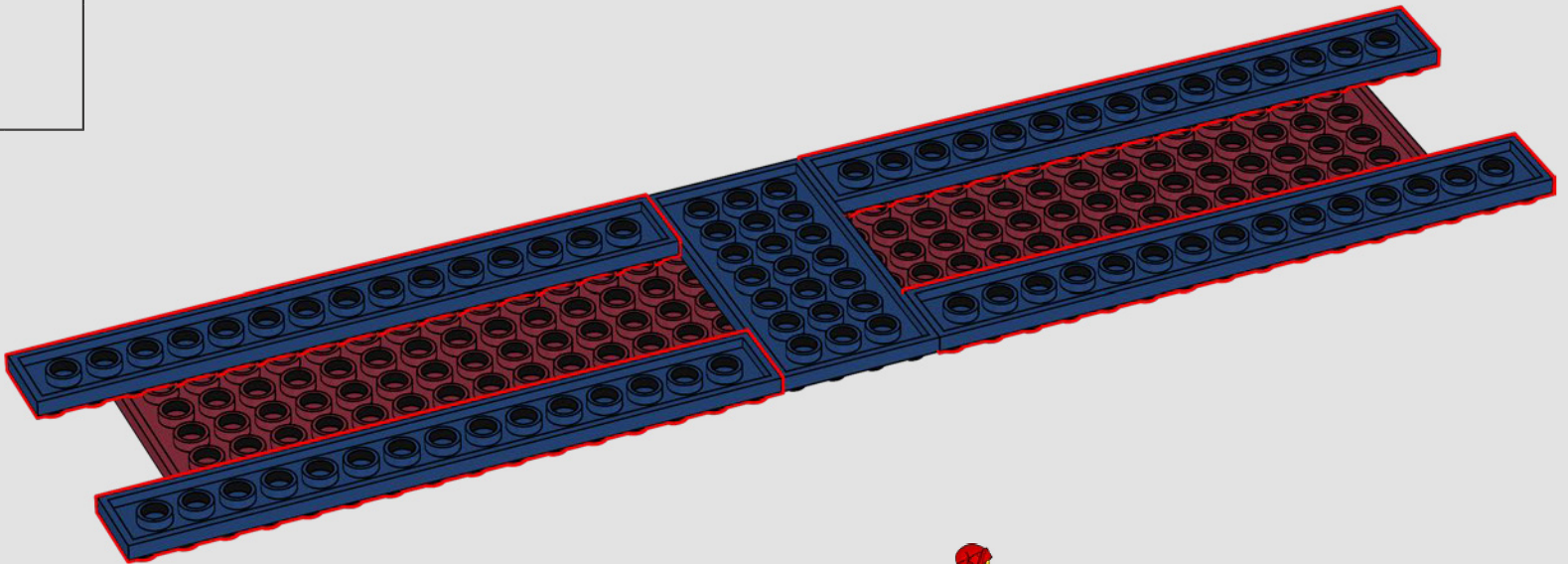

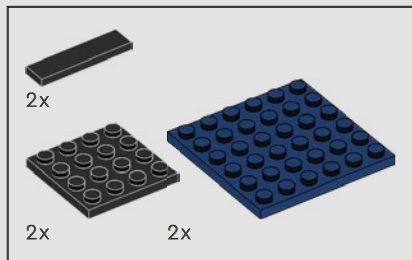

141

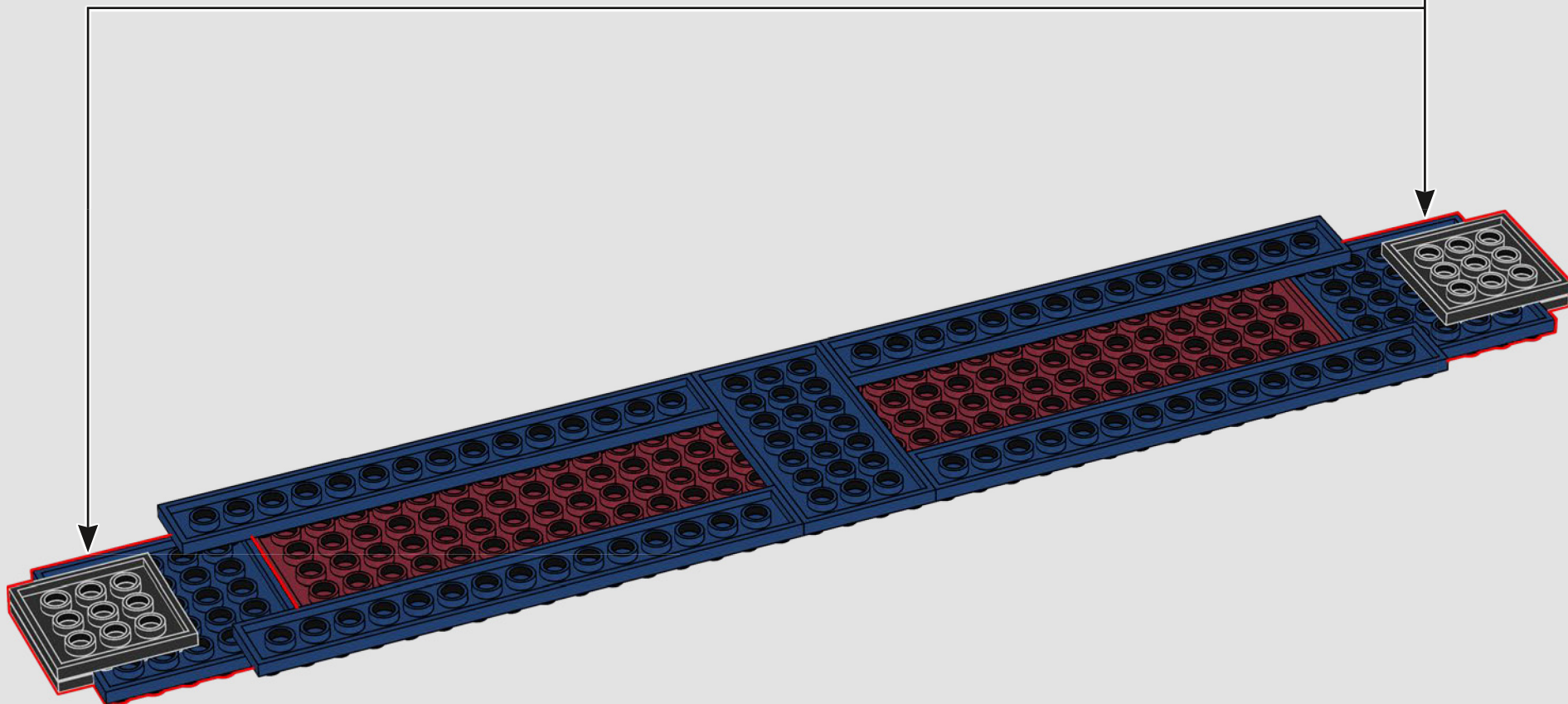
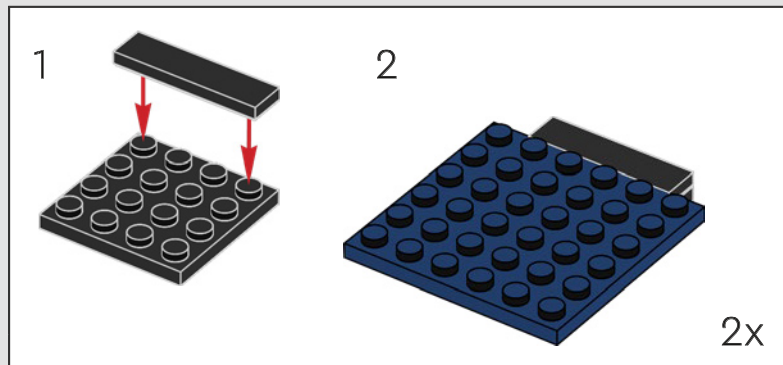

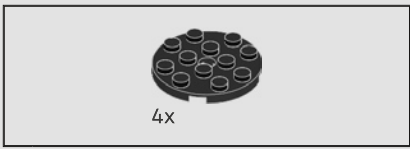

142

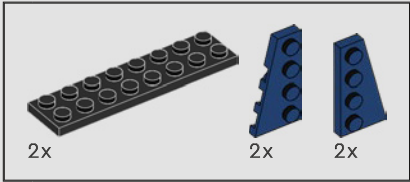

143

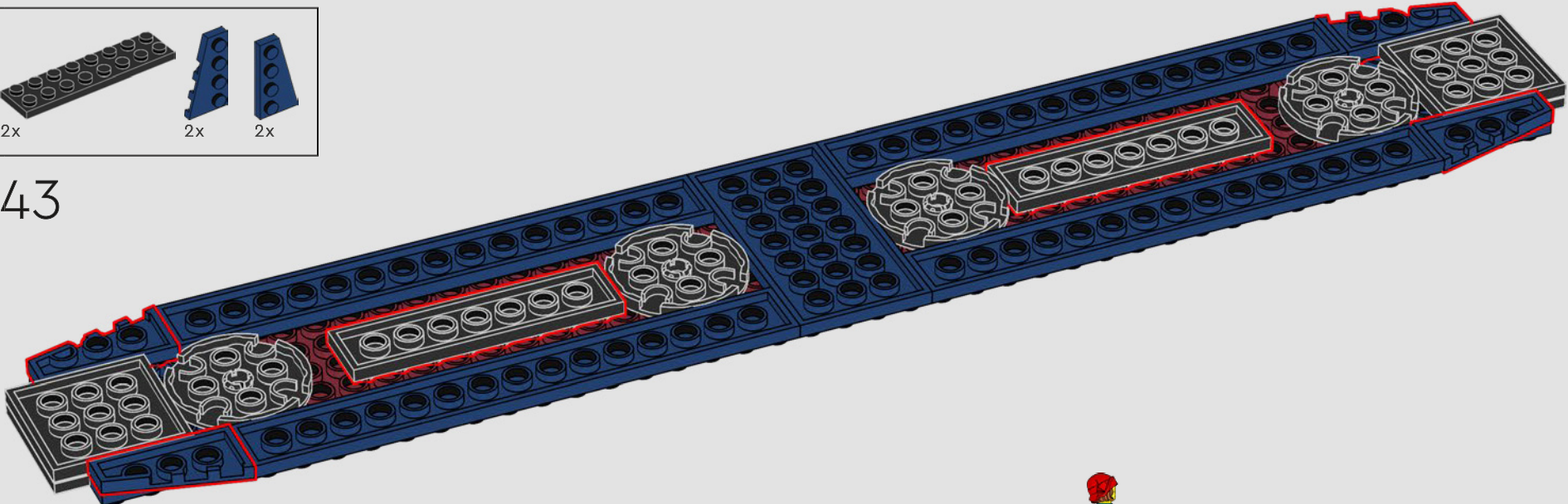

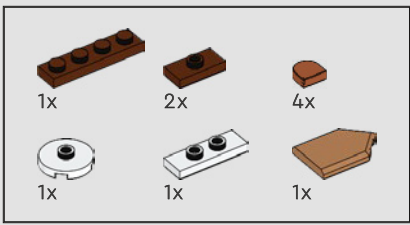

146

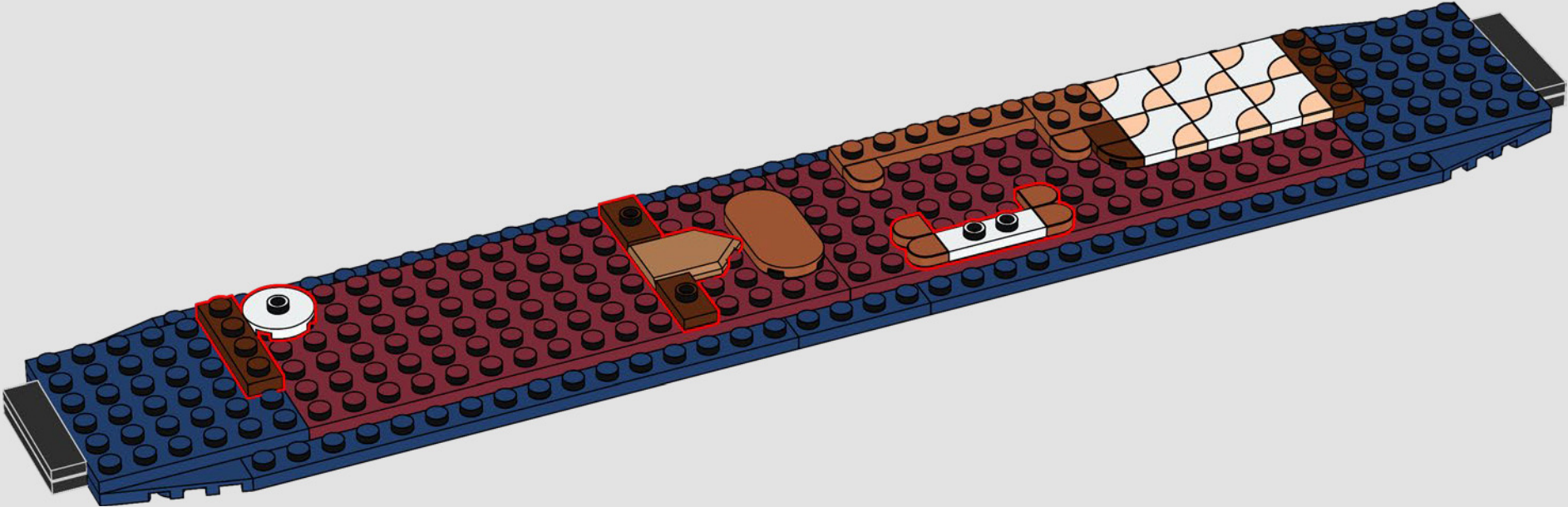

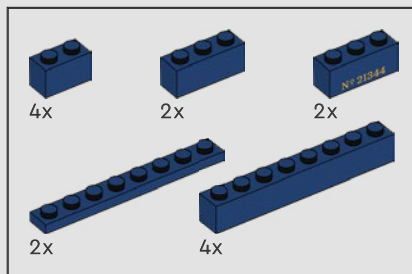

147

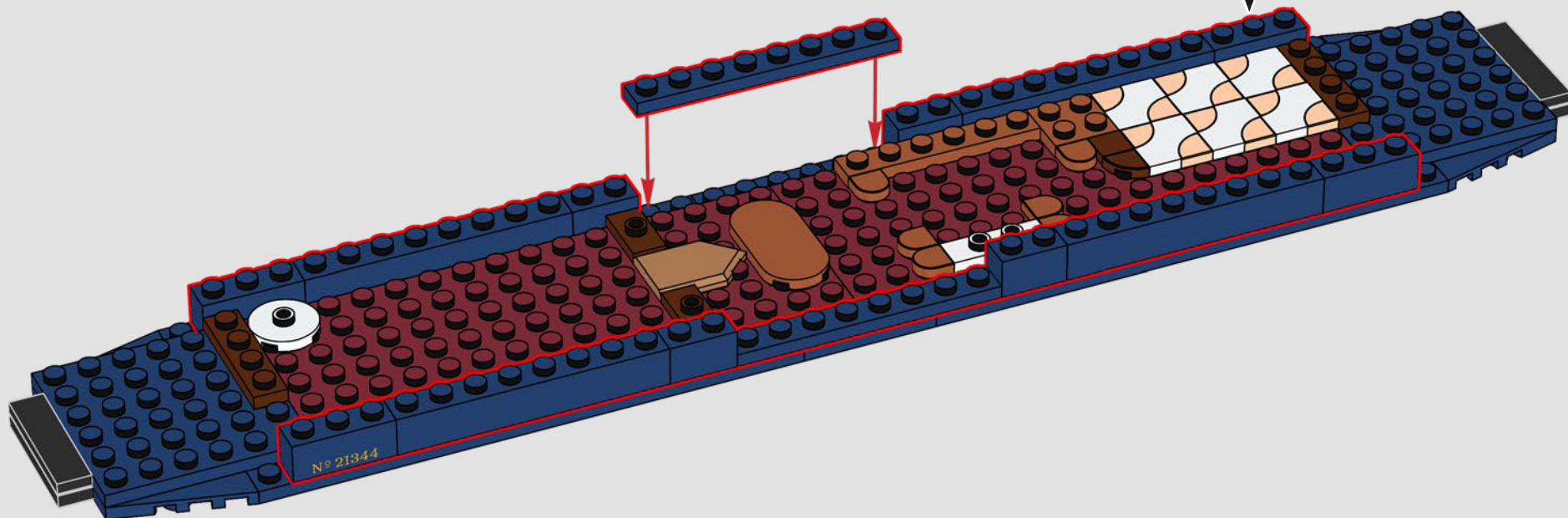

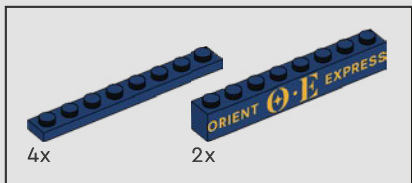

148

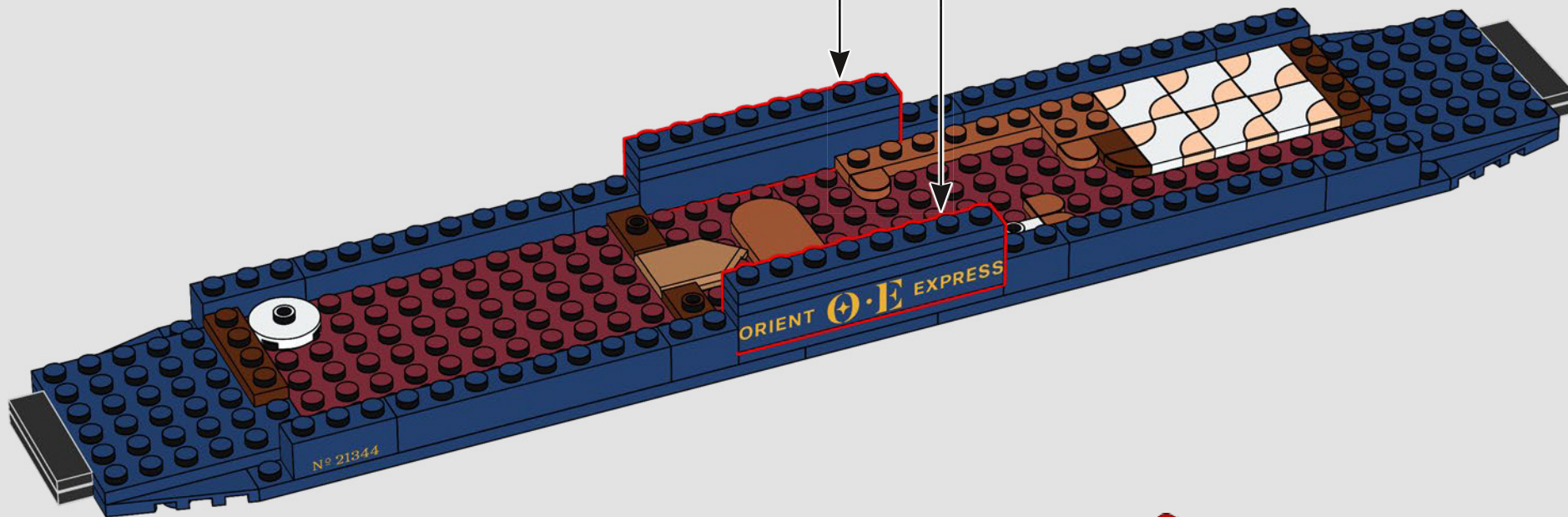
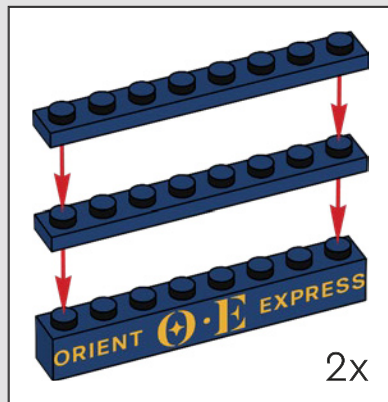

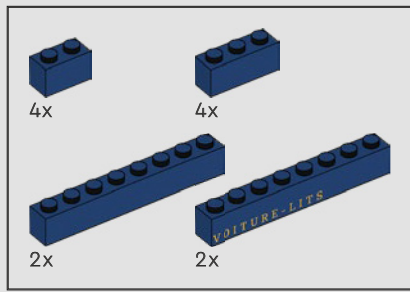

149

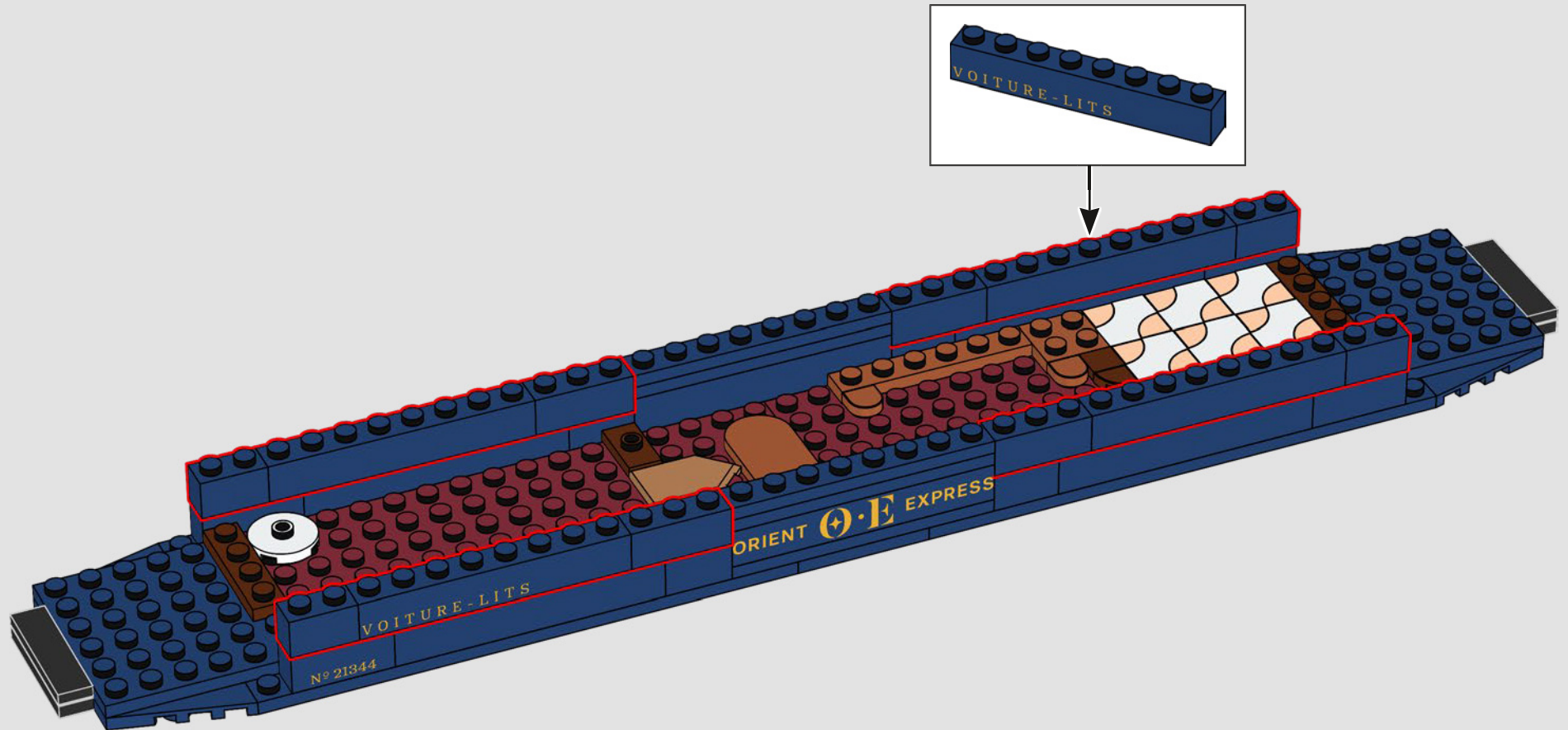

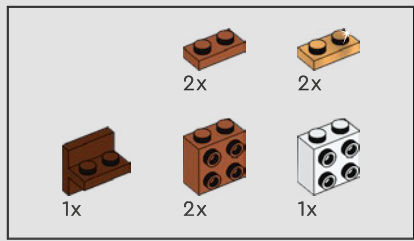

150

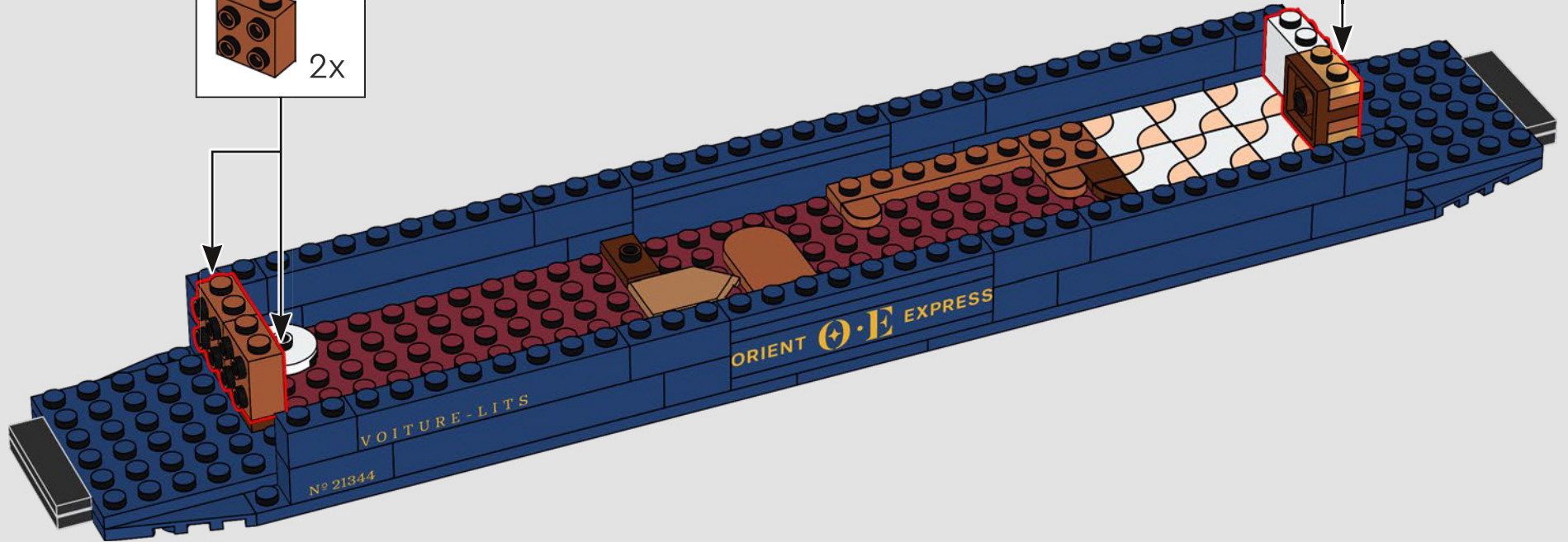
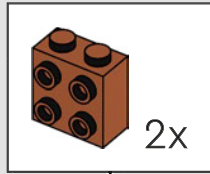
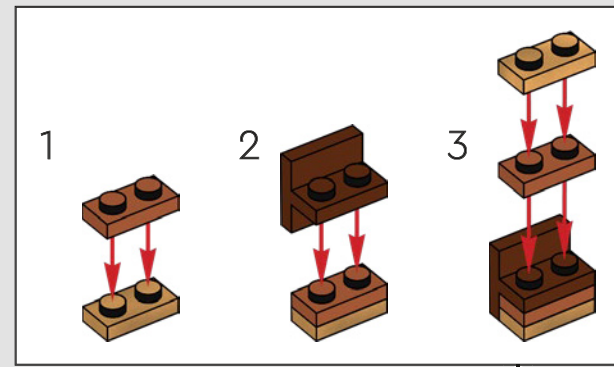

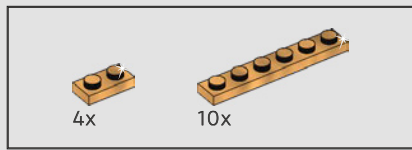

151

.....●
下一站:布达佩斯
“沿着多瑙河向布达佩斯驶去,
河水像金子一样闪闪发光。”

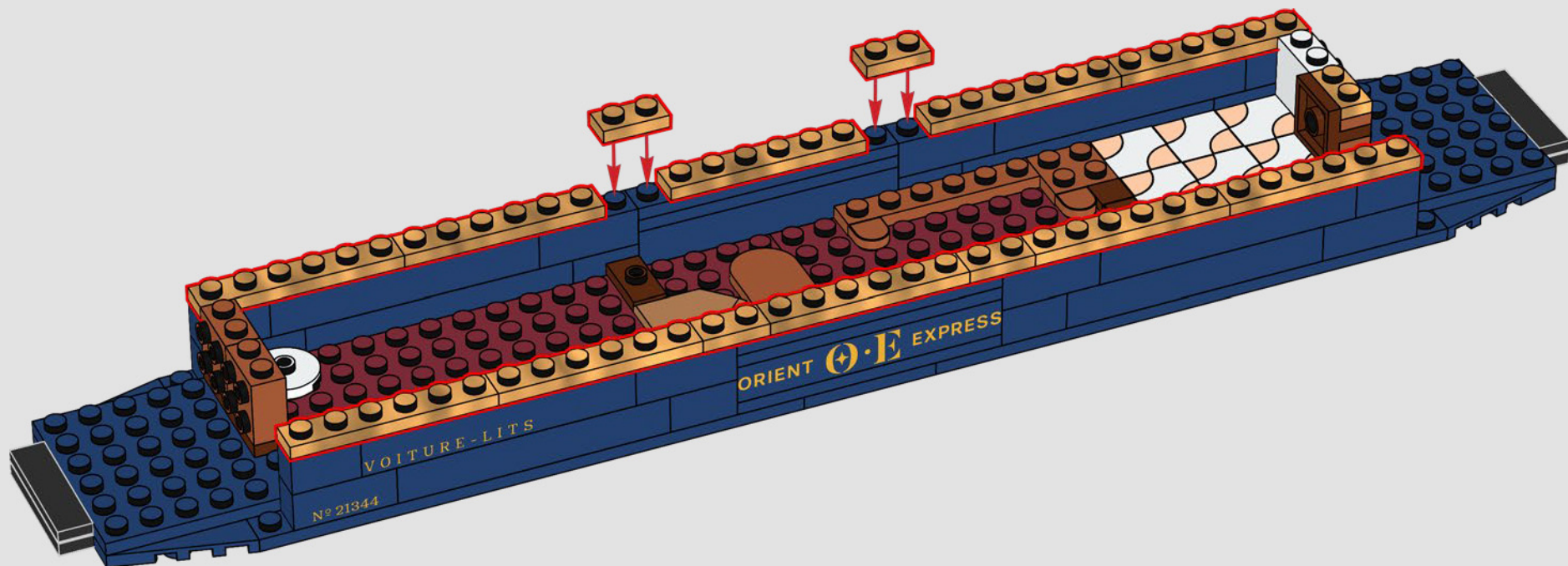

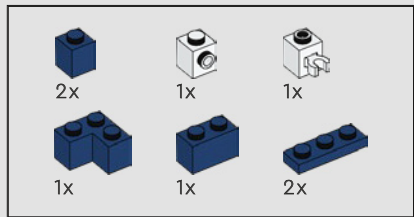

152

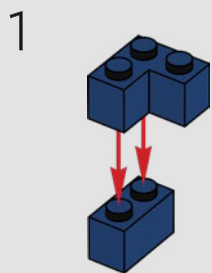

2

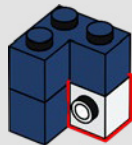

3

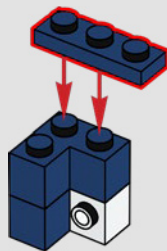

4

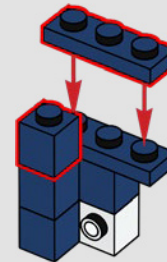

5

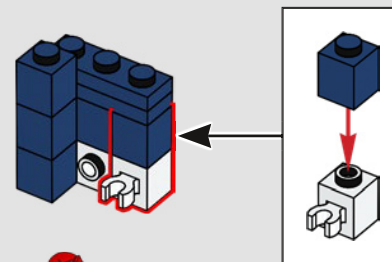

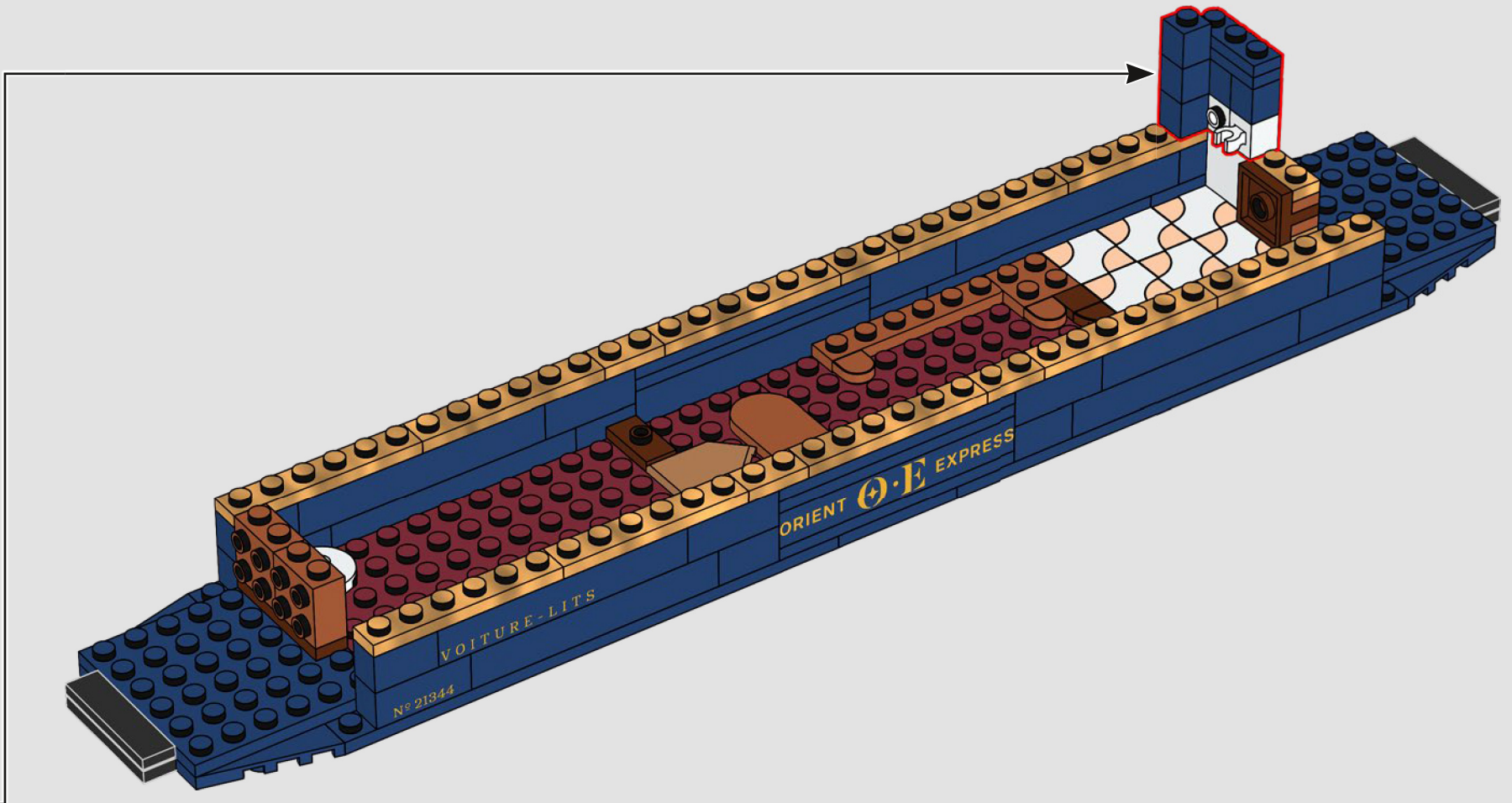

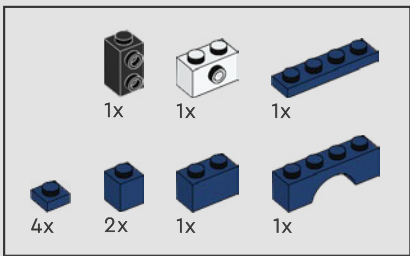

153

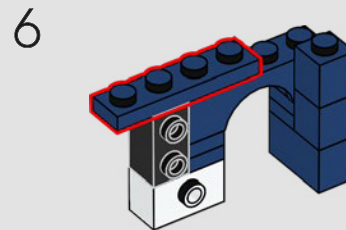
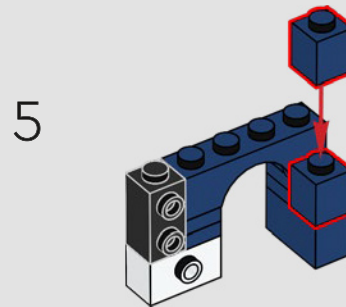
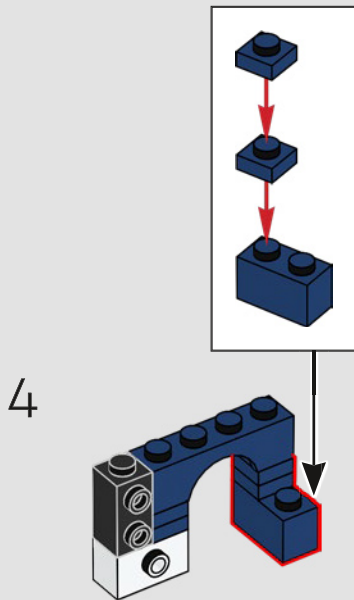
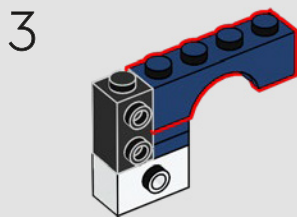
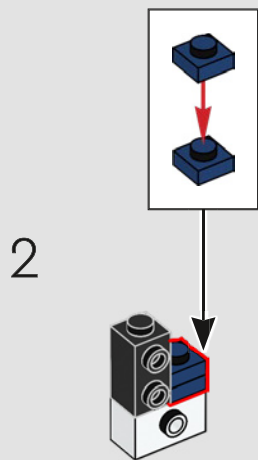
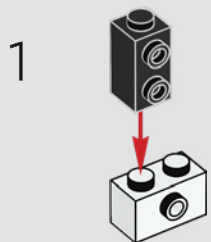

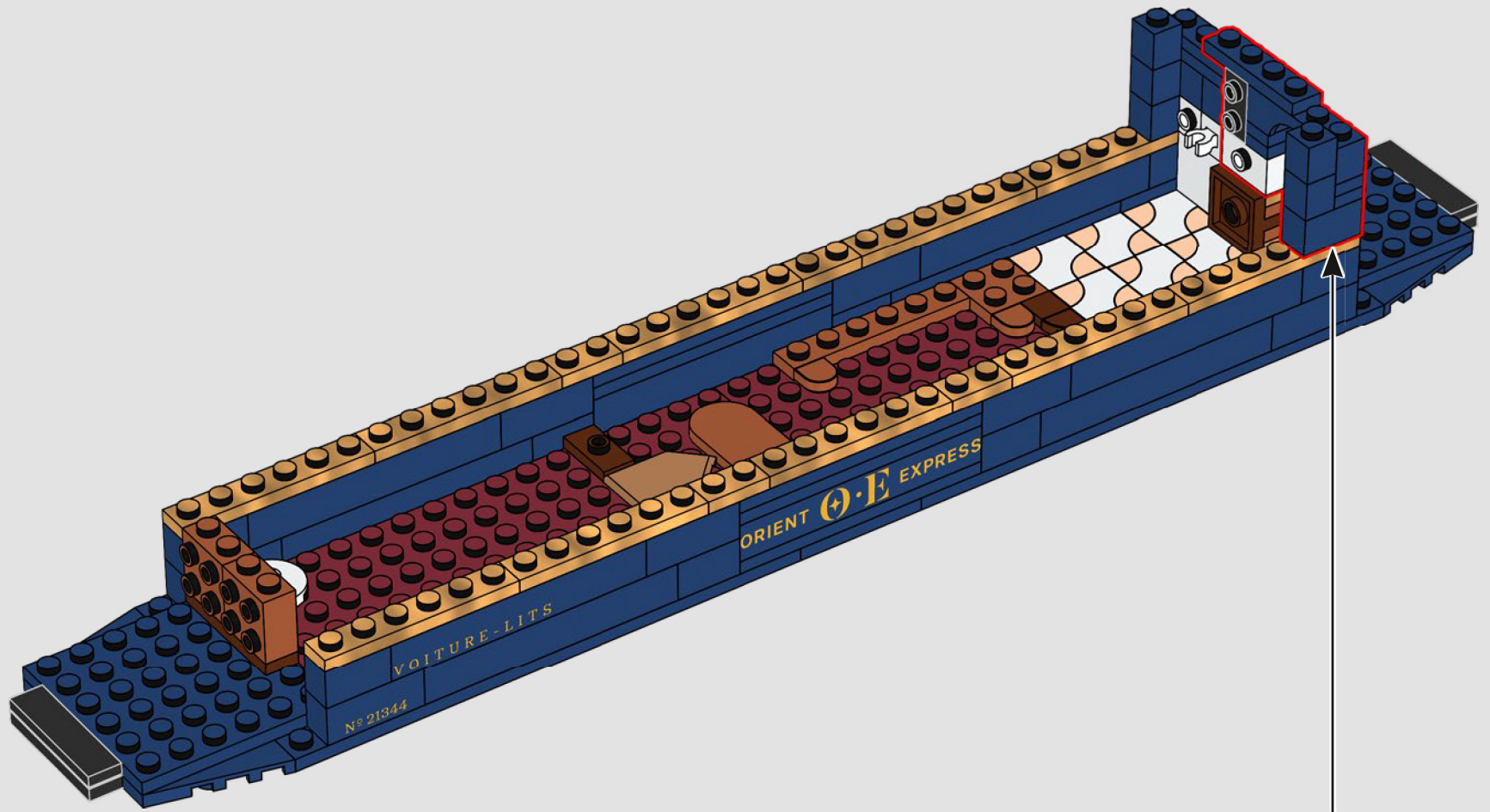

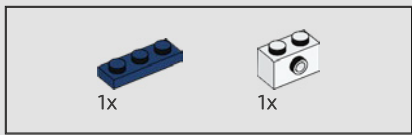

154

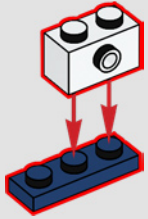

155

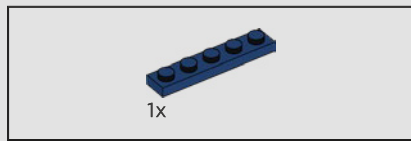
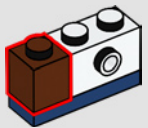

156

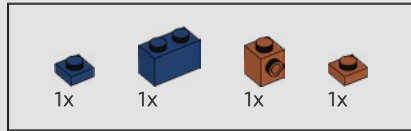
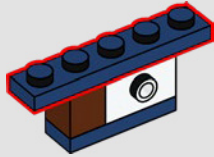

157

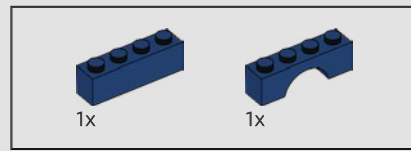
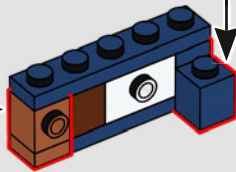
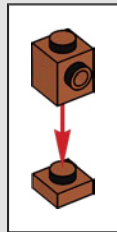
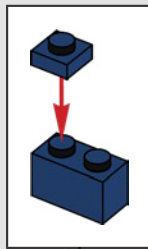

158

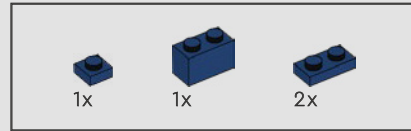
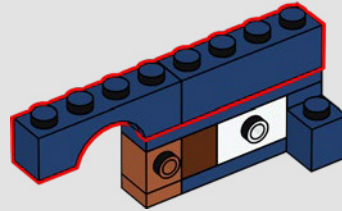

159

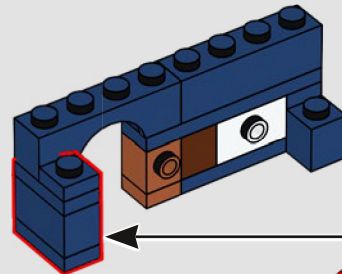
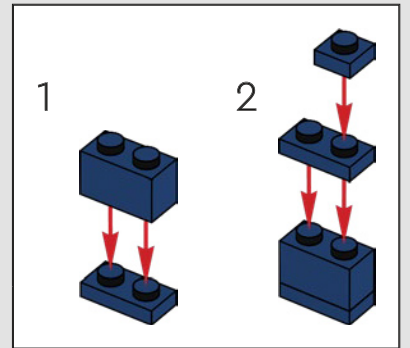

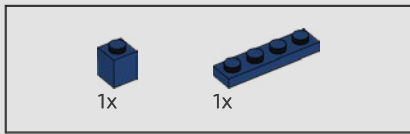

160

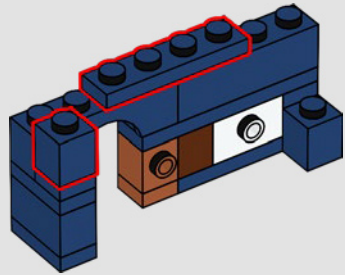

161

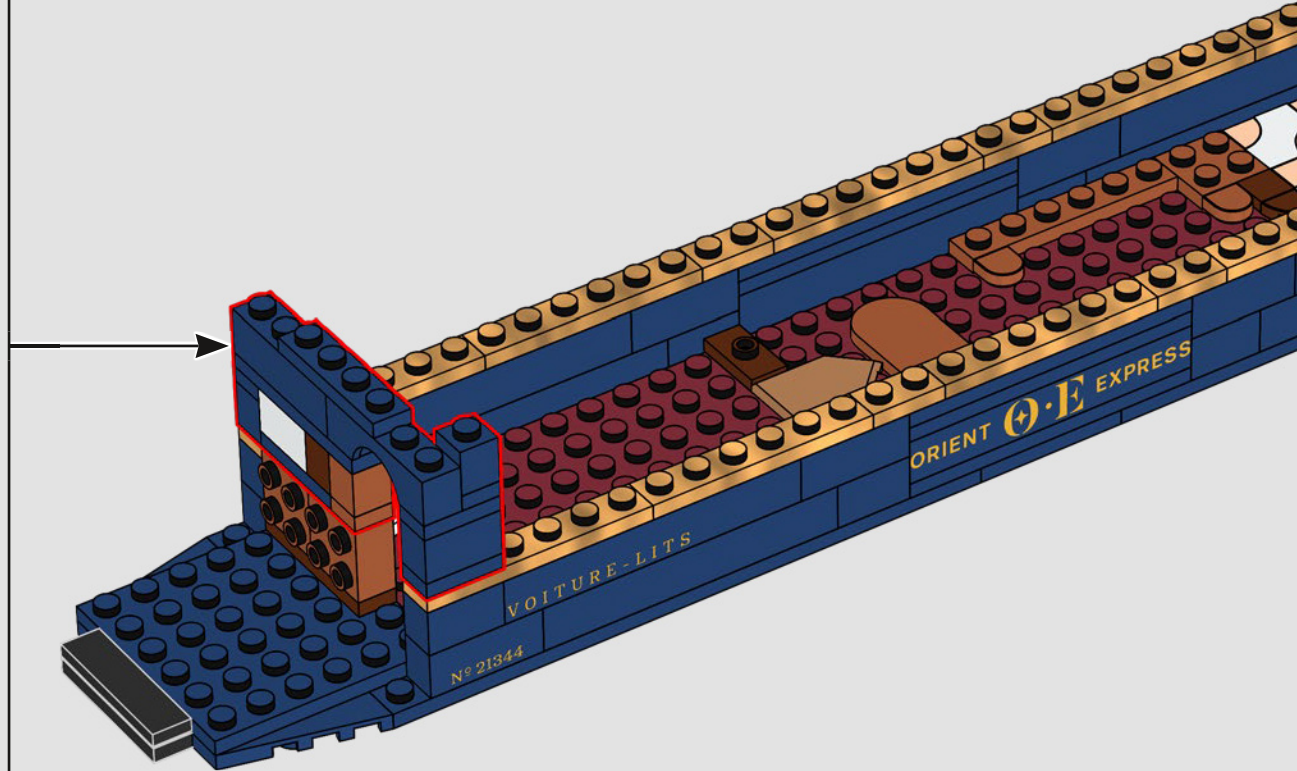

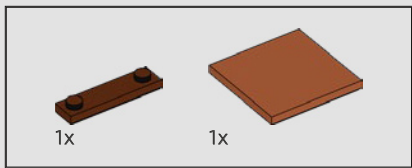

162

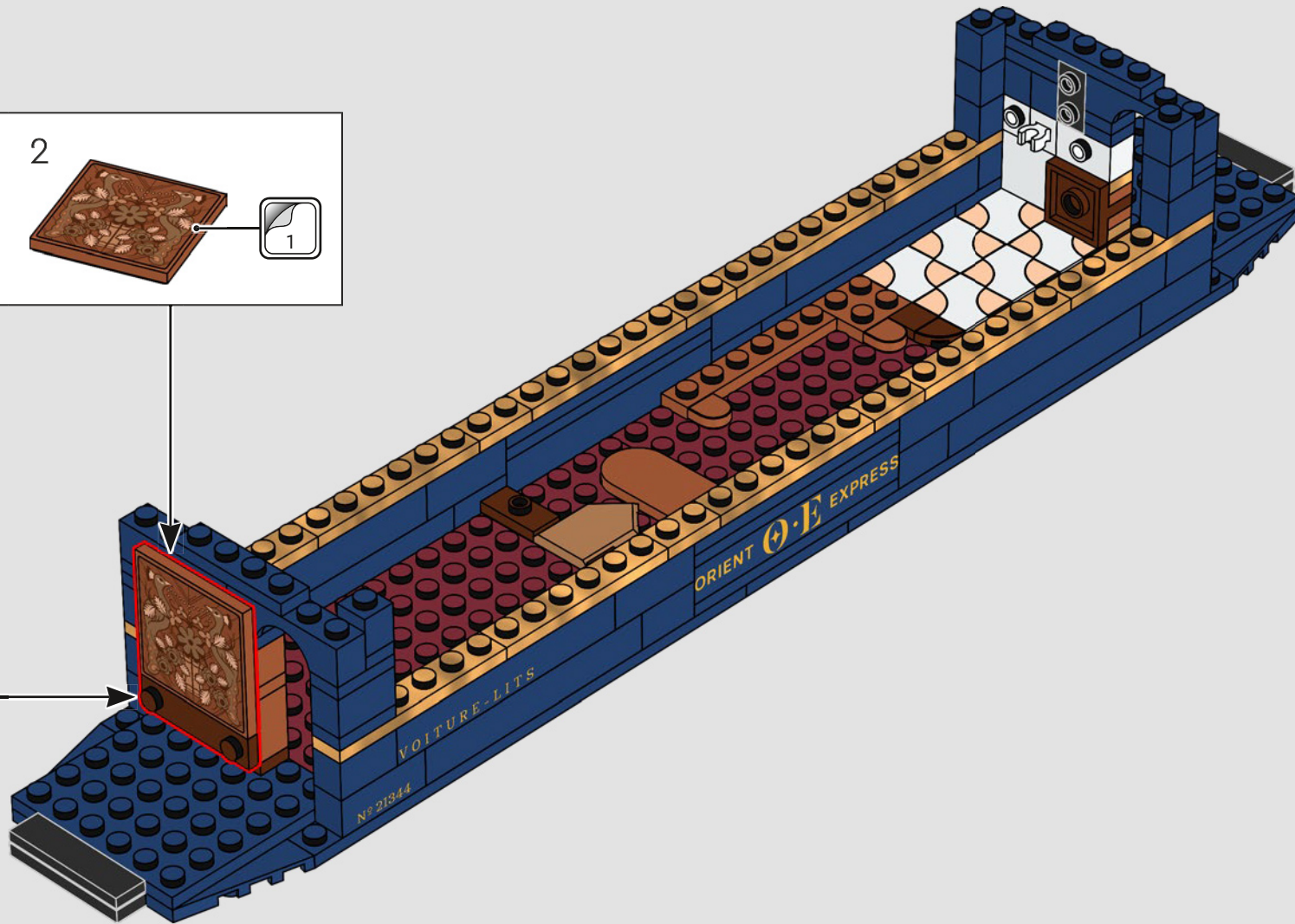
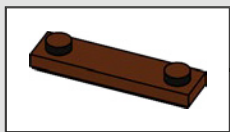

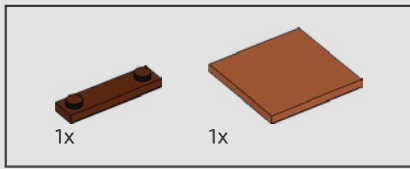

163

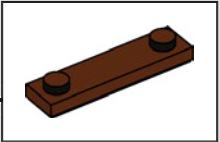
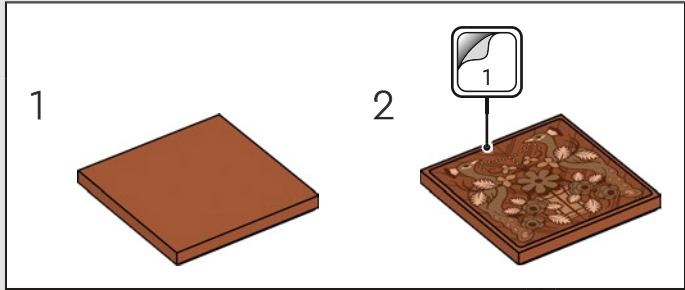
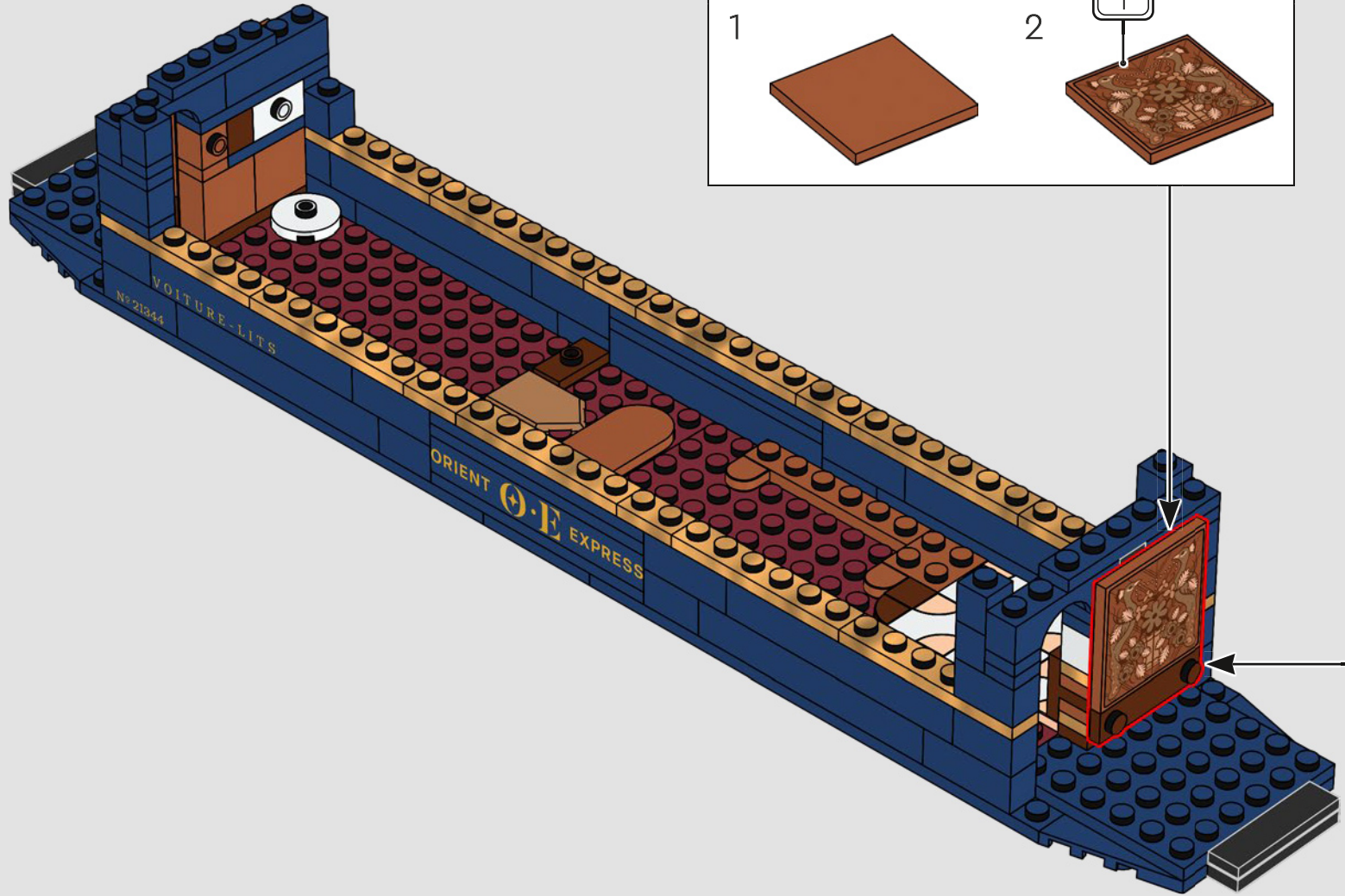

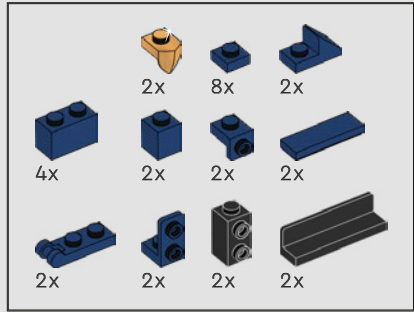
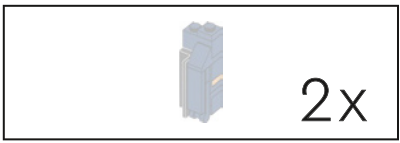

164

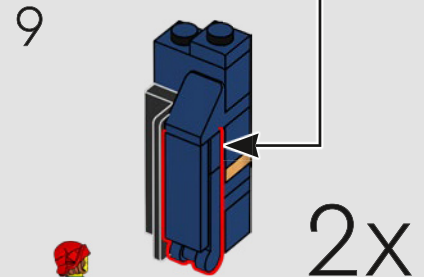
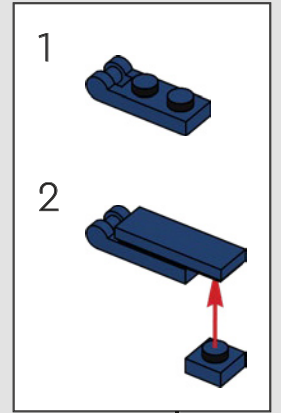
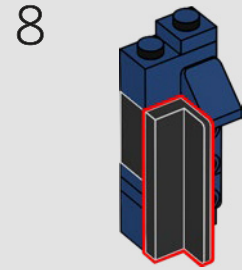
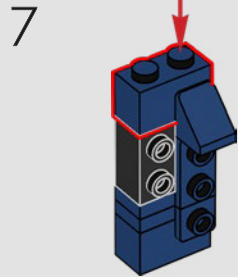
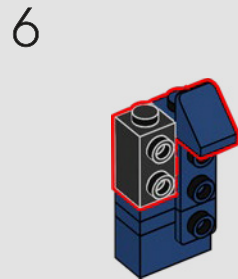
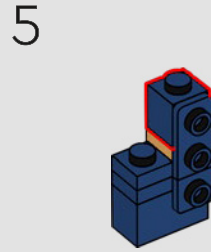
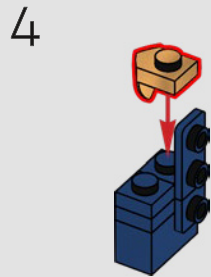
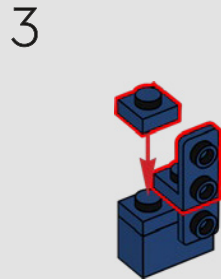
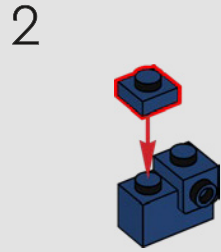
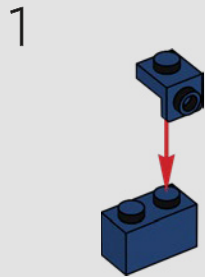

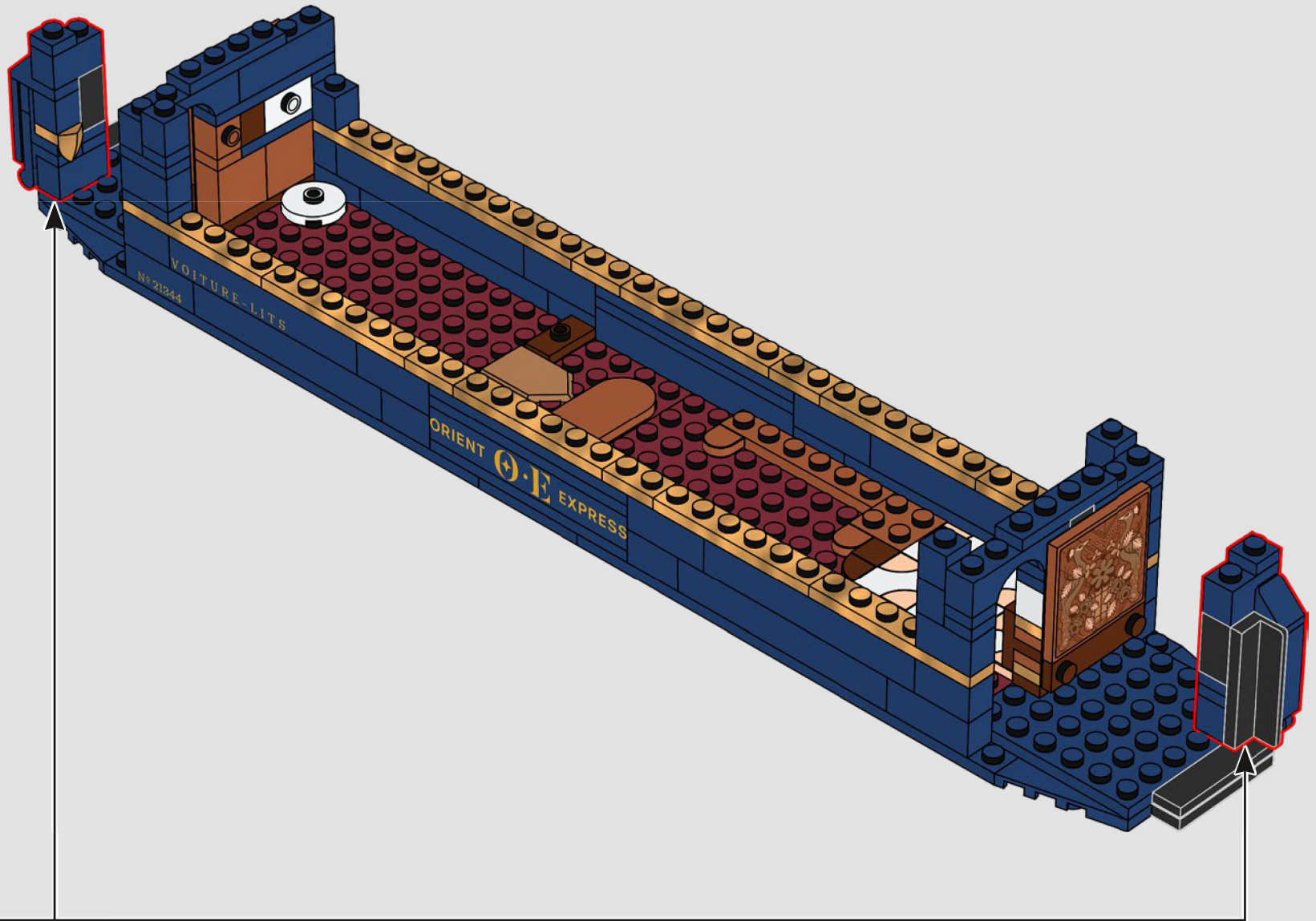



2x

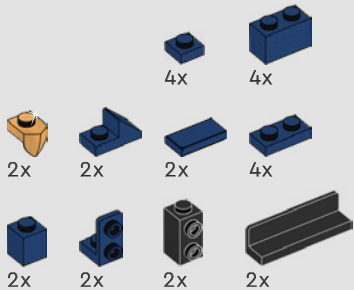

165

1

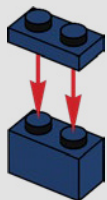

2

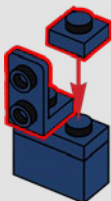

3

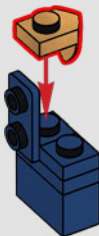

4

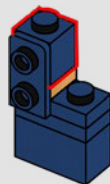

5

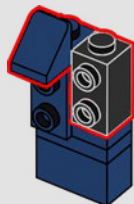

6

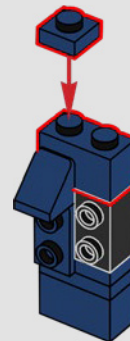

7

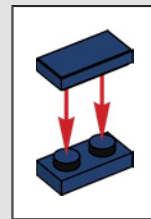

8

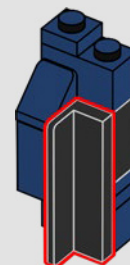

2x



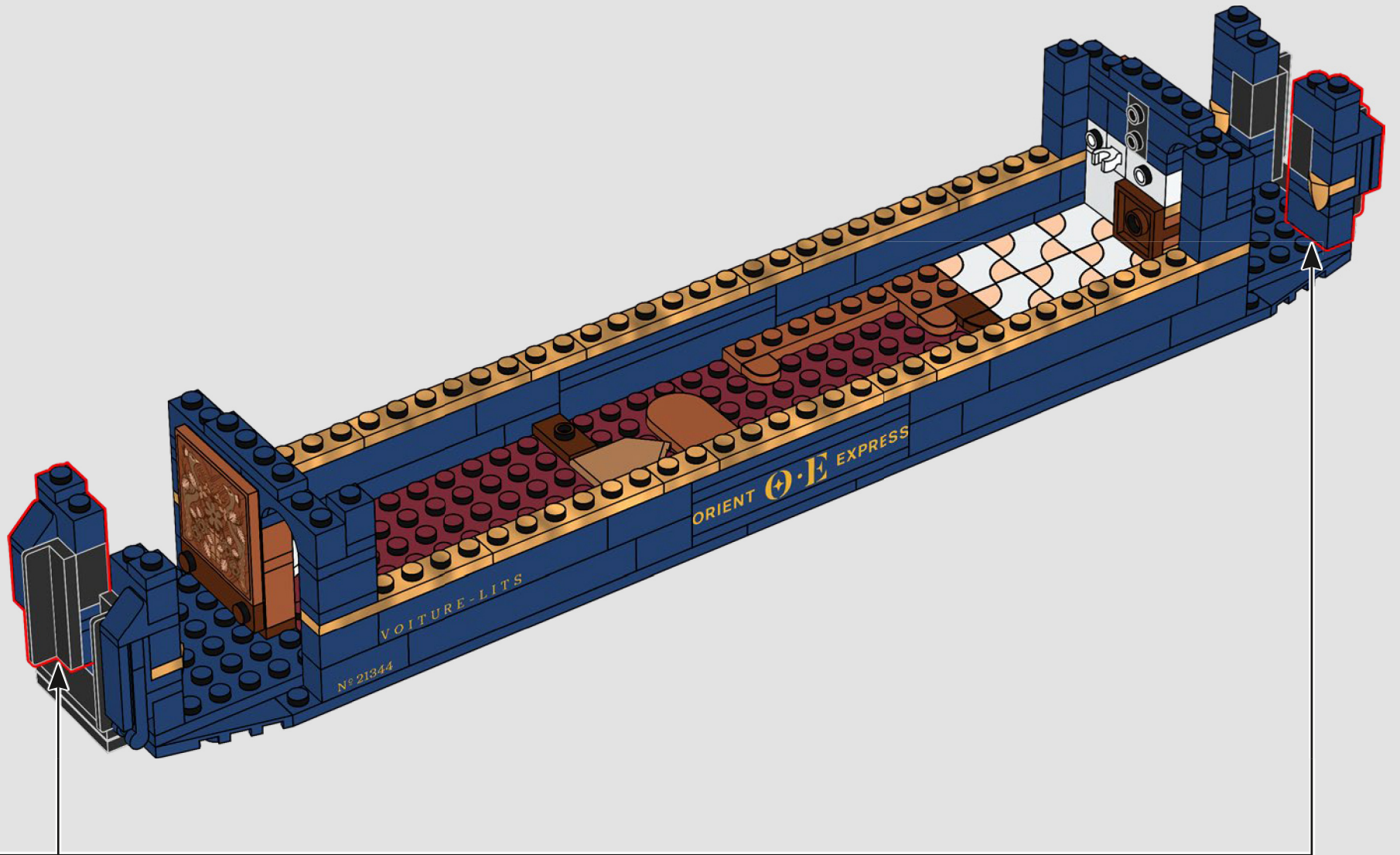

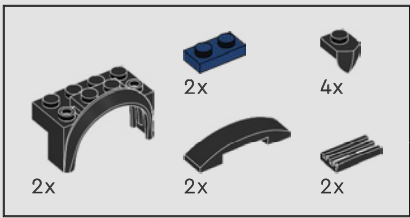

166

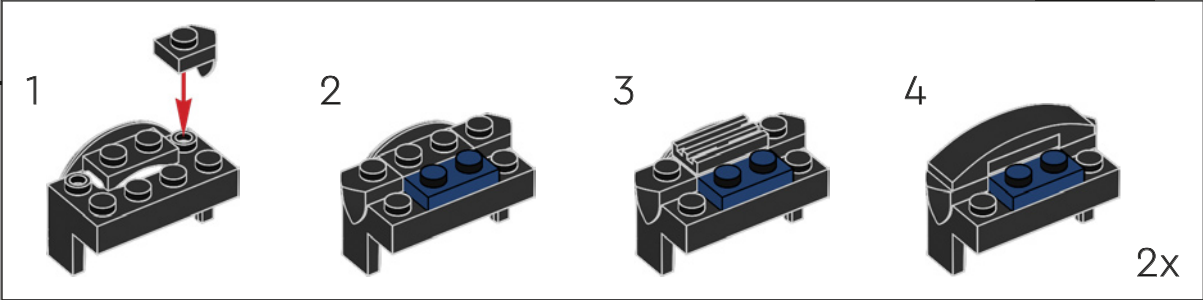
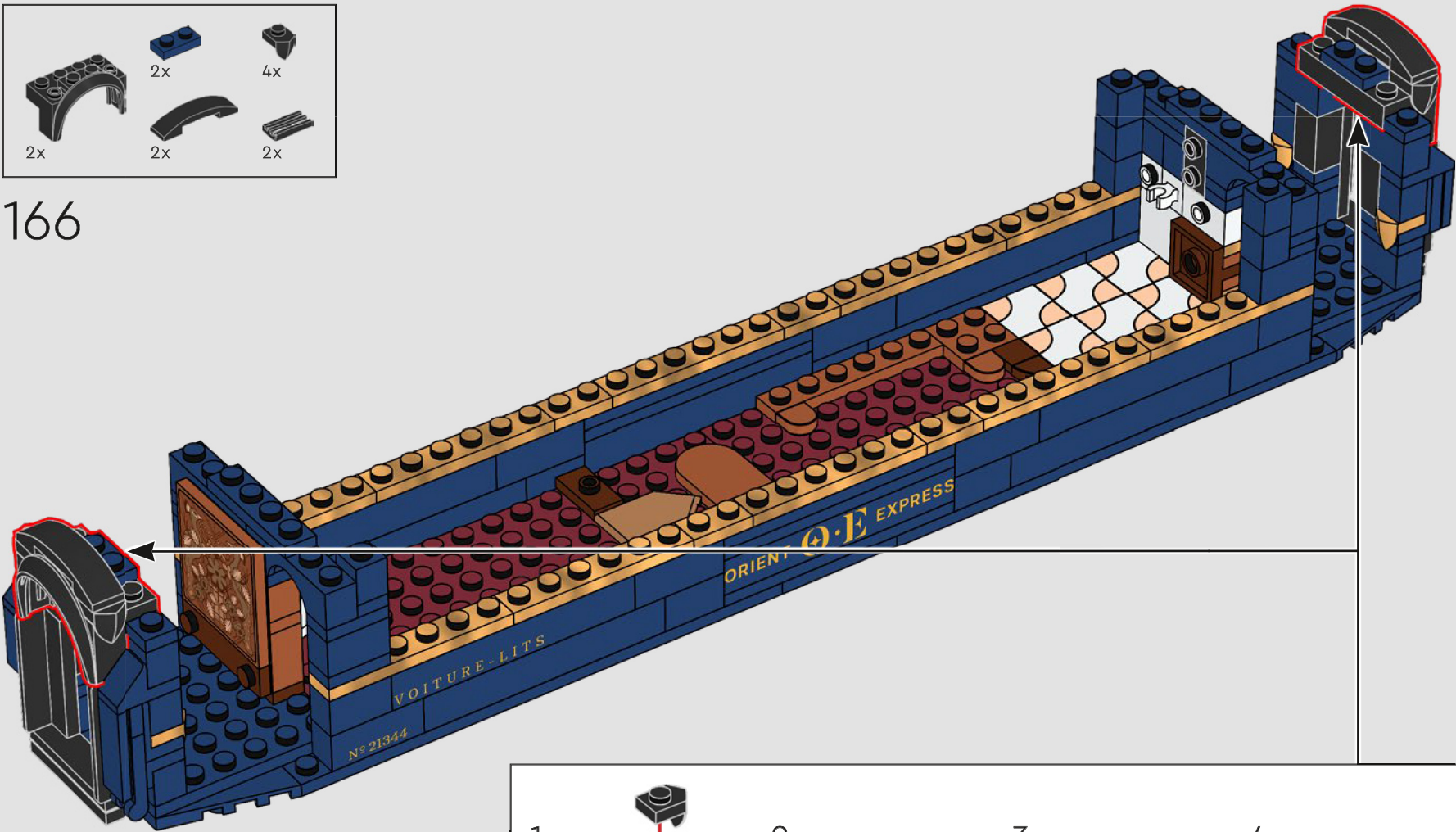

“每节卧铺车厢都安排有列车员，
以满足我们的各种需求。”

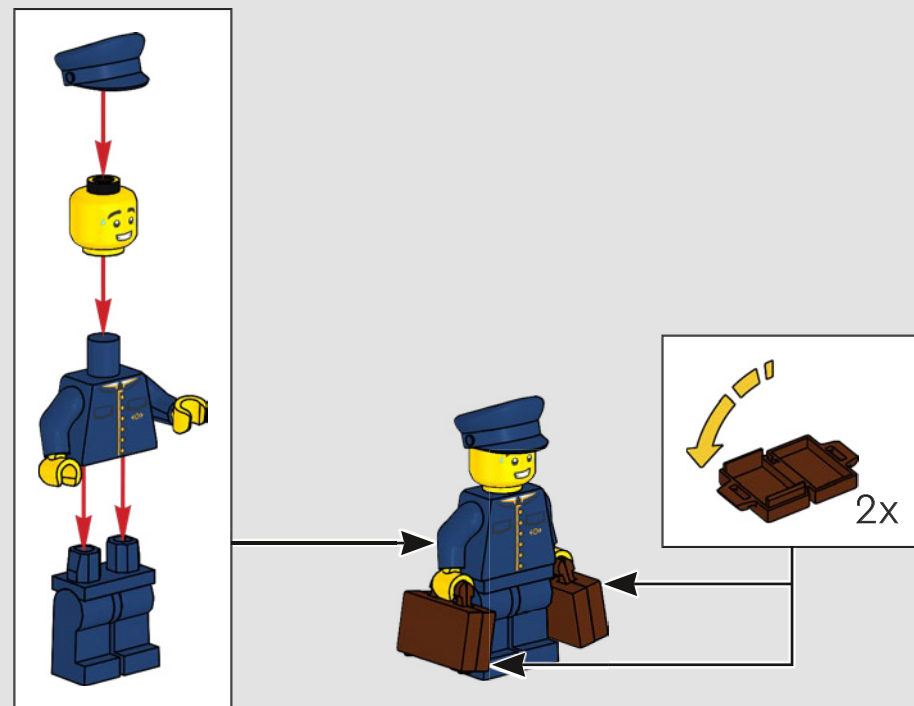

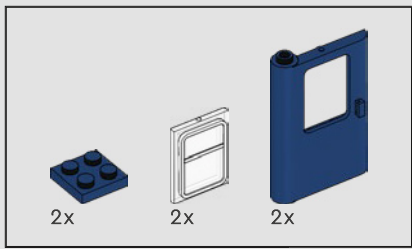

167

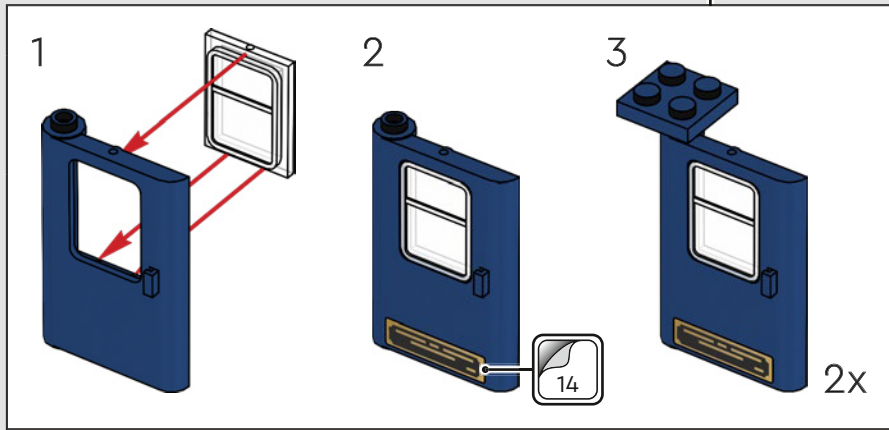
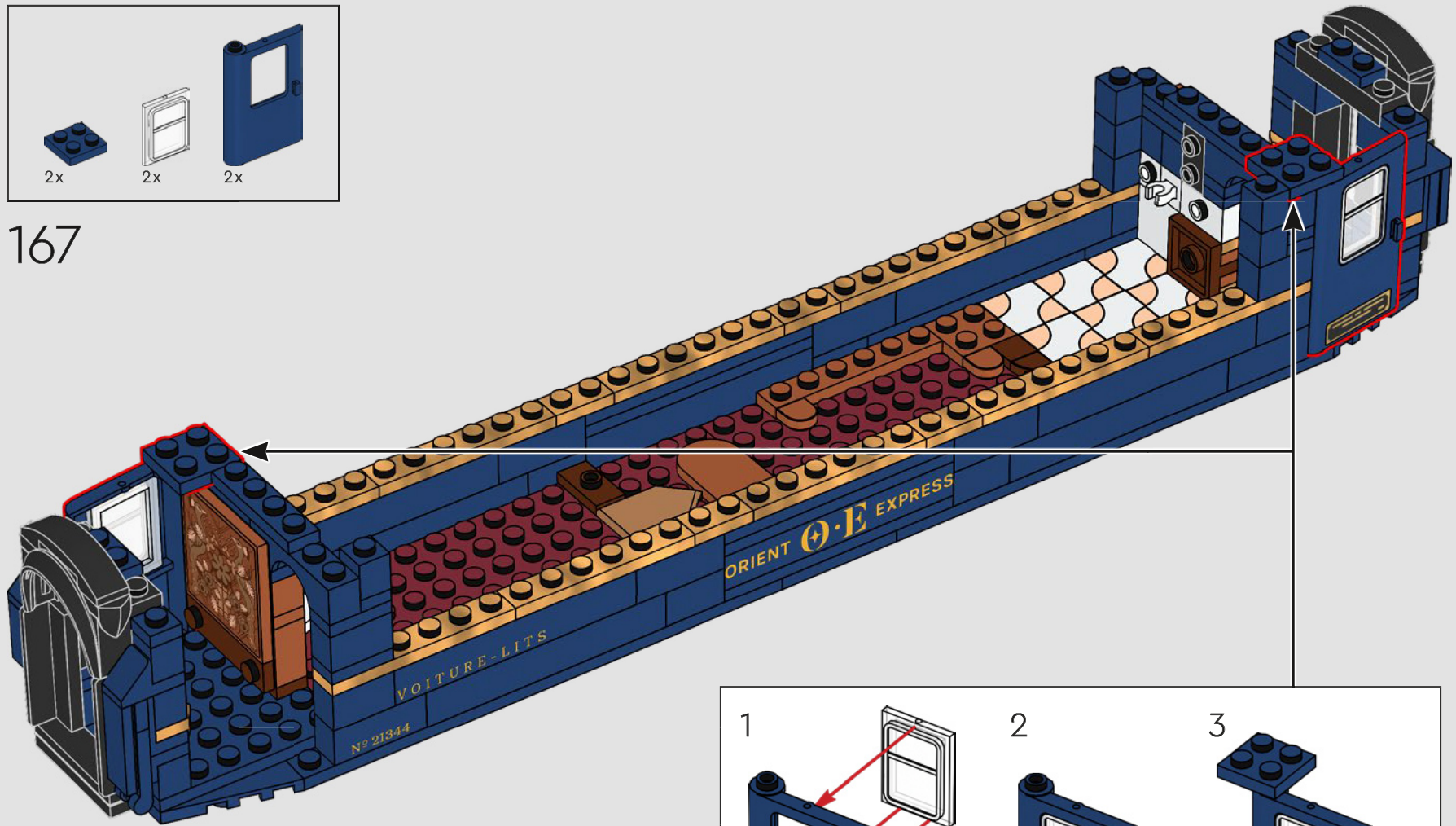

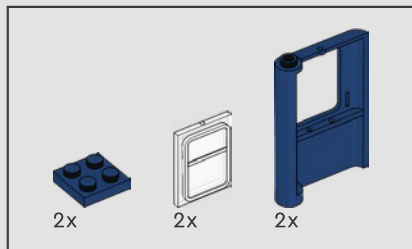

168

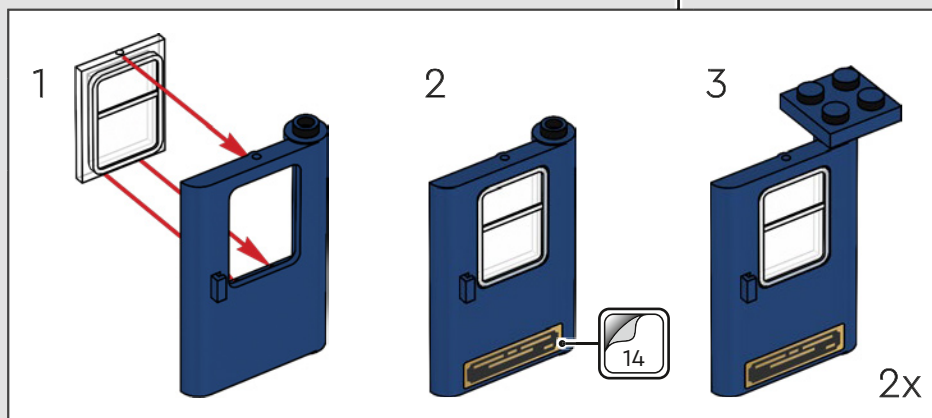
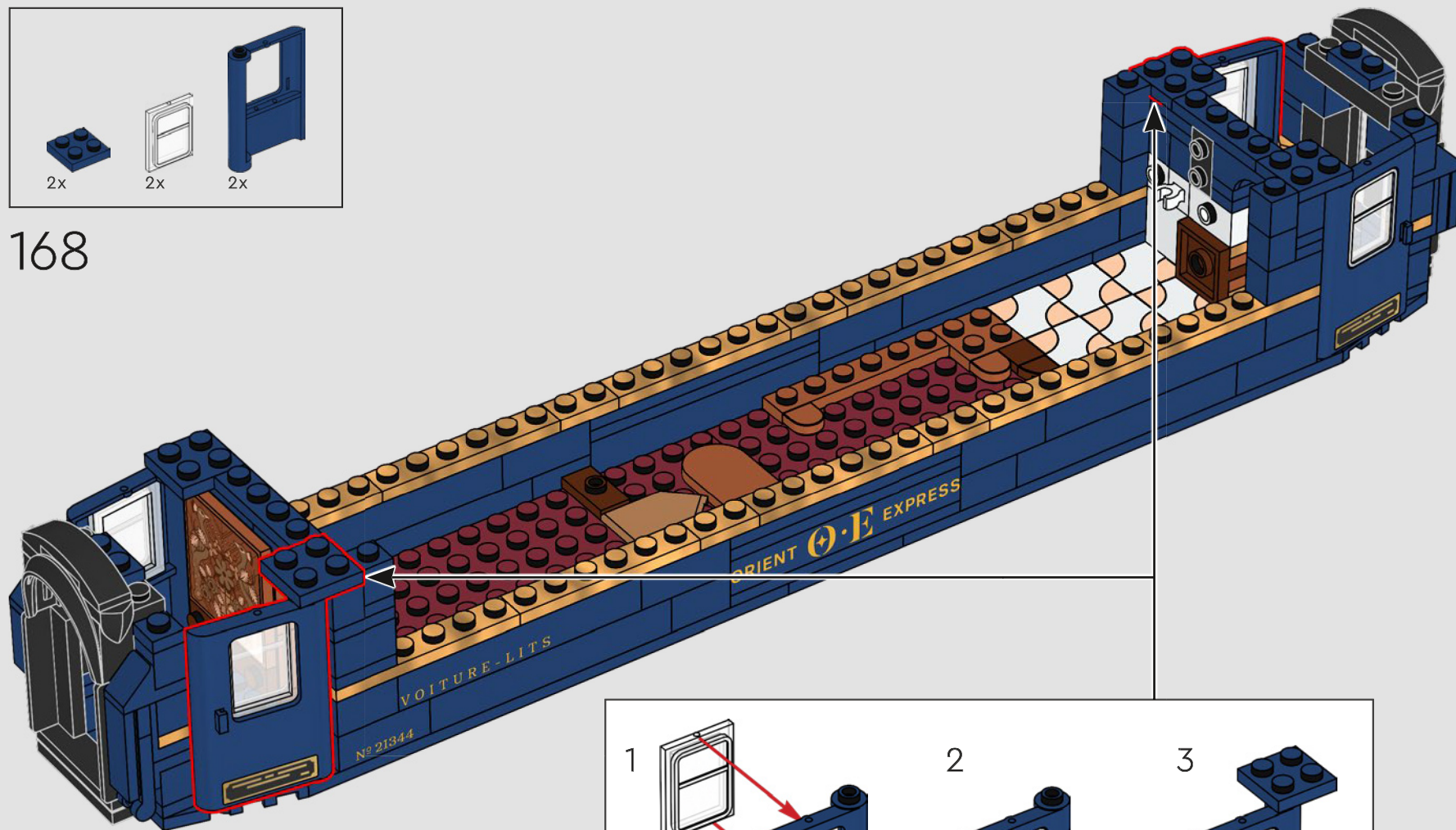

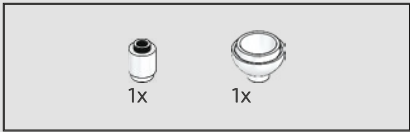

169

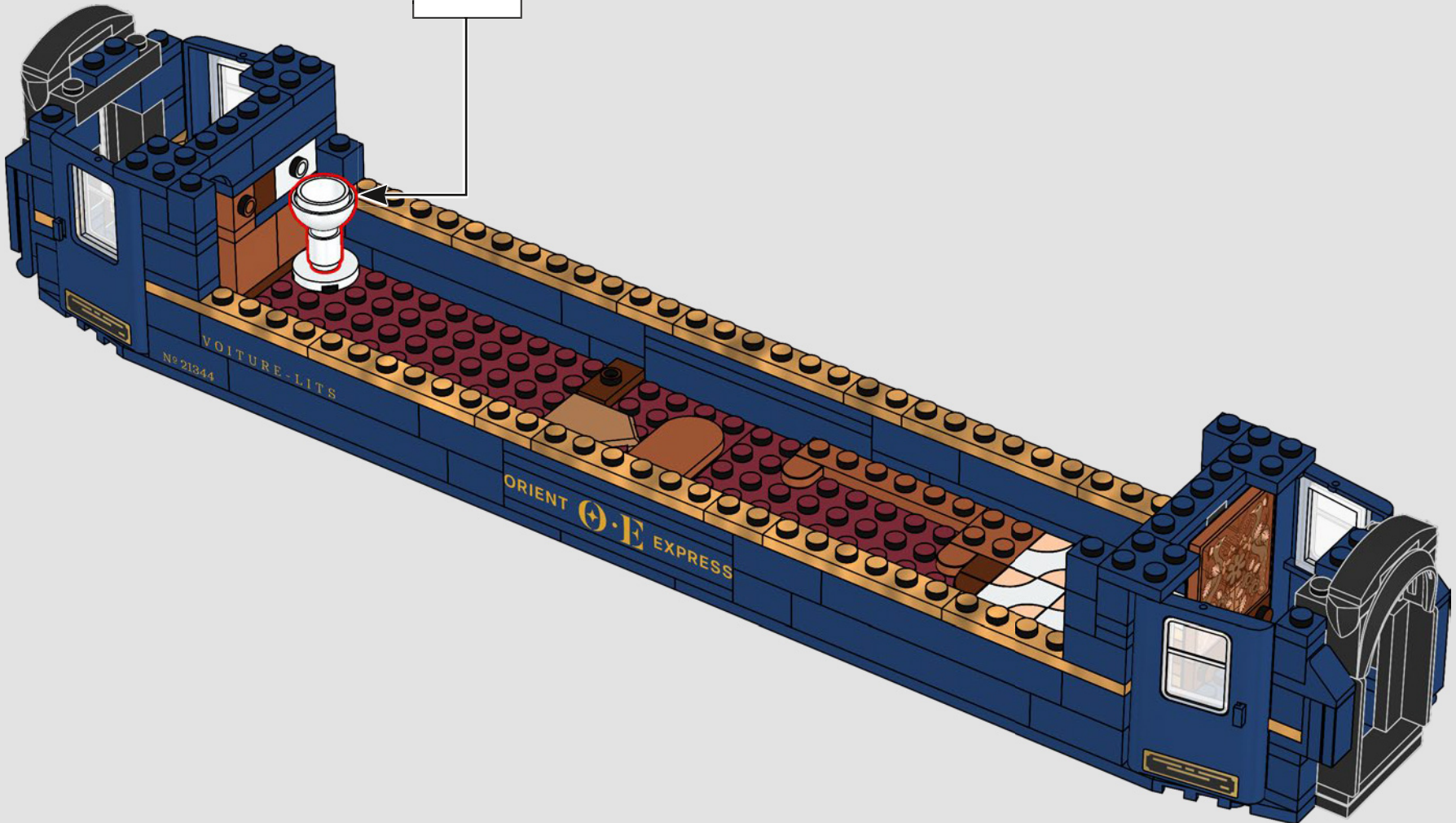



170

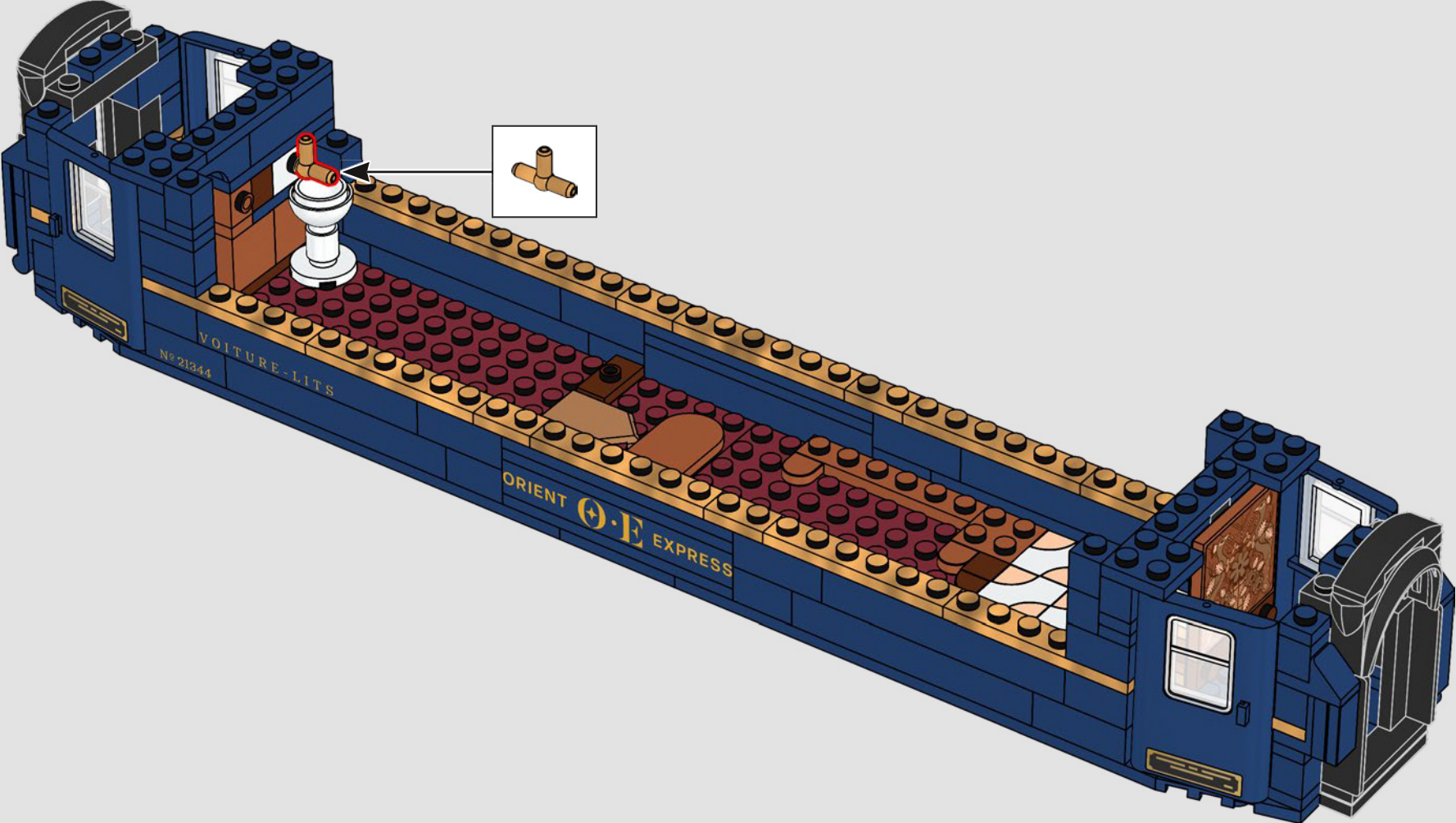



171

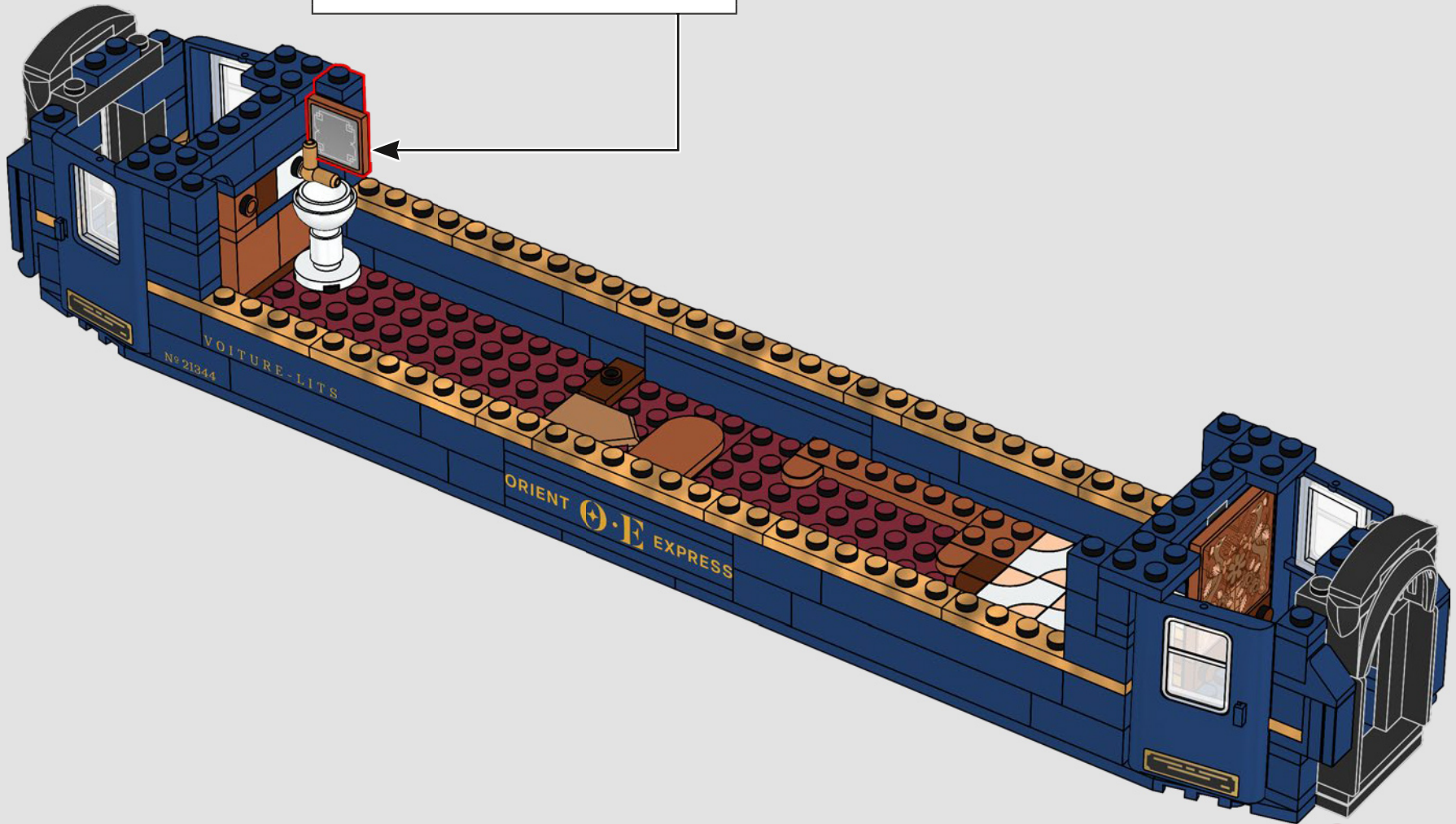
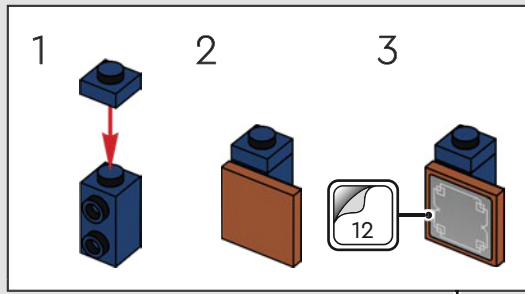

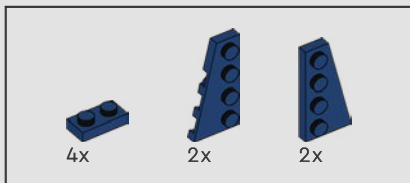

172

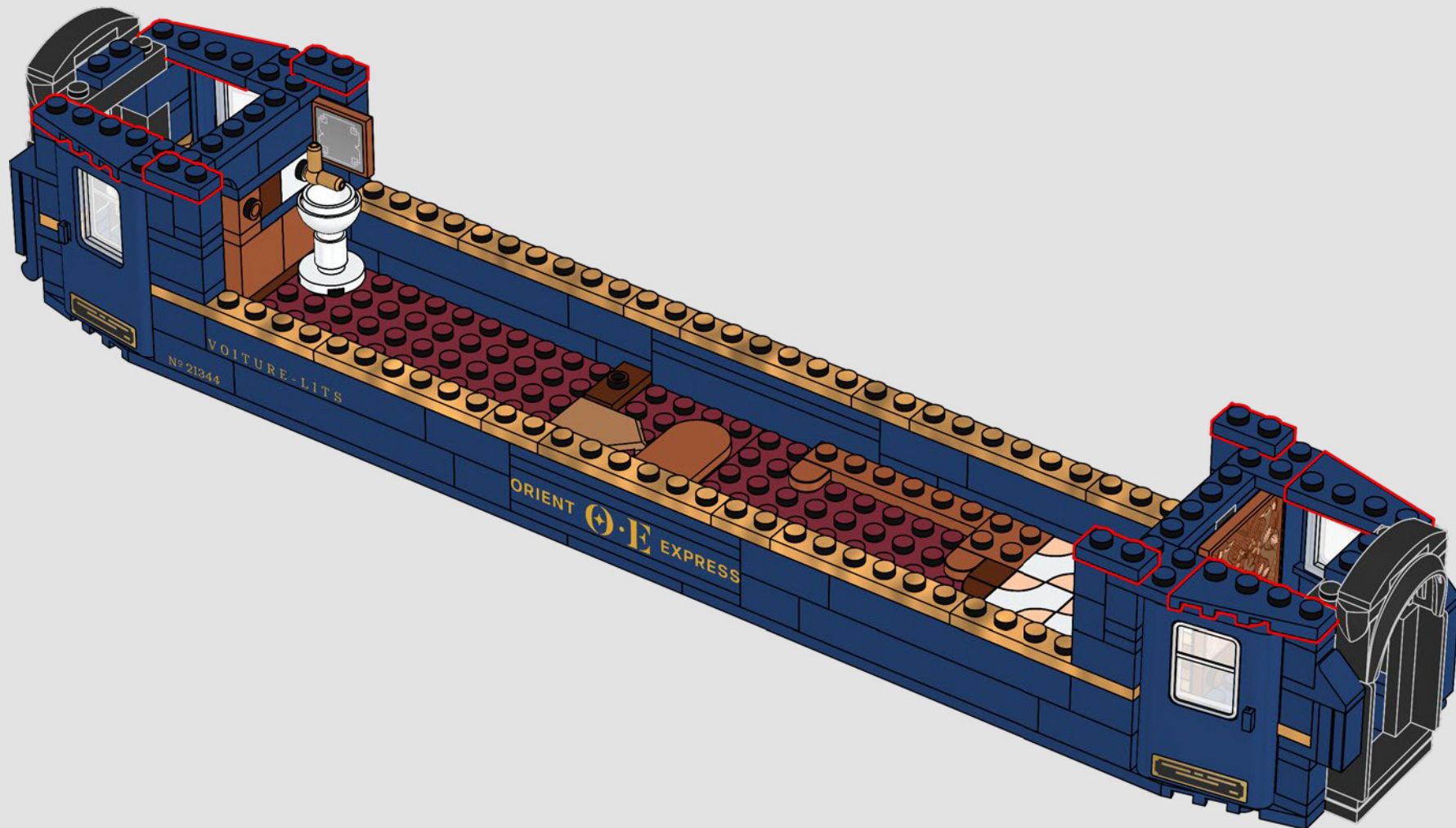

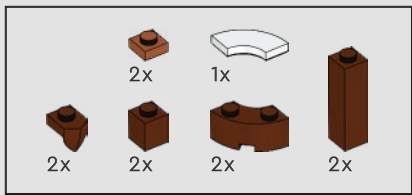

173

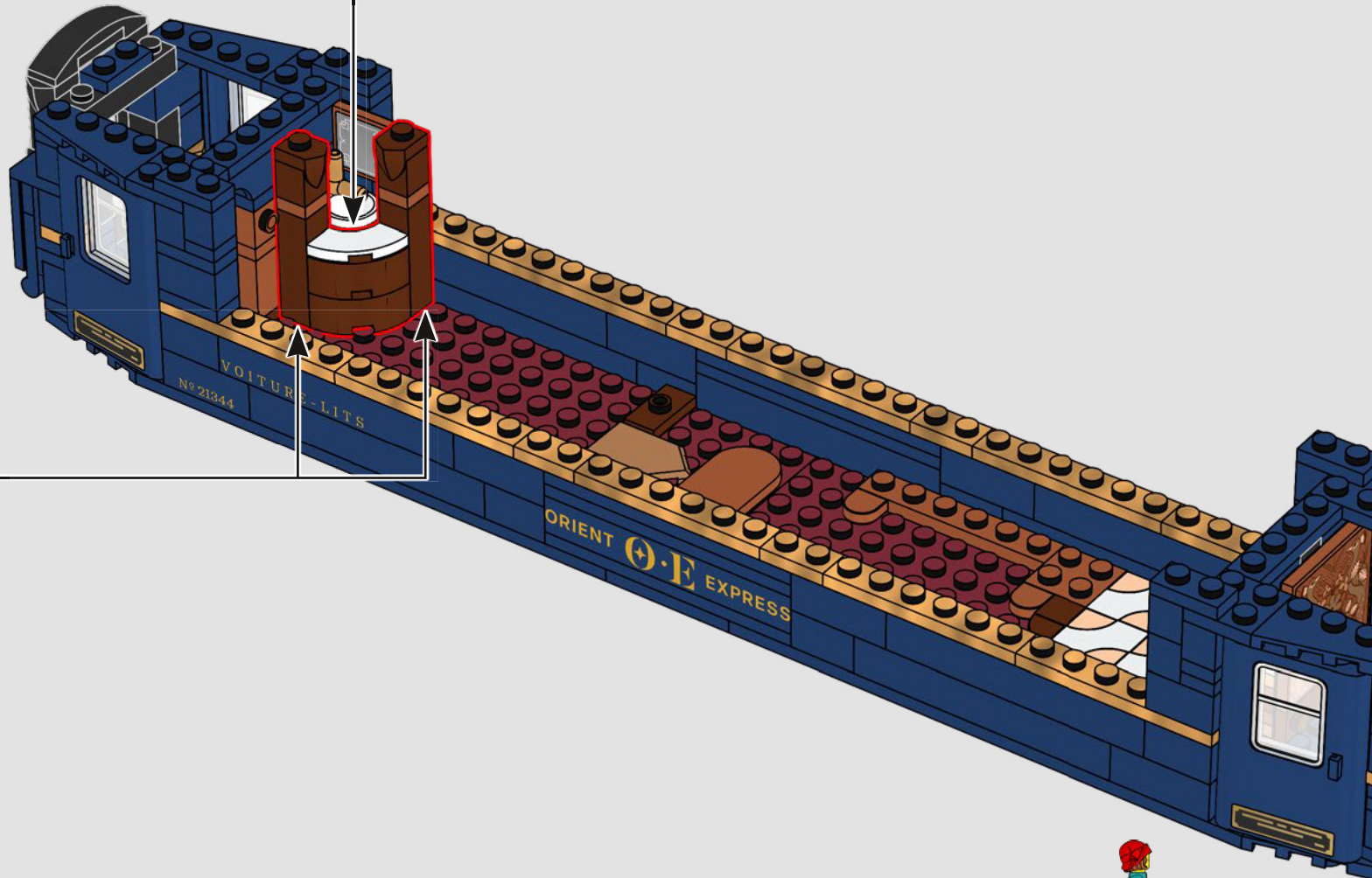
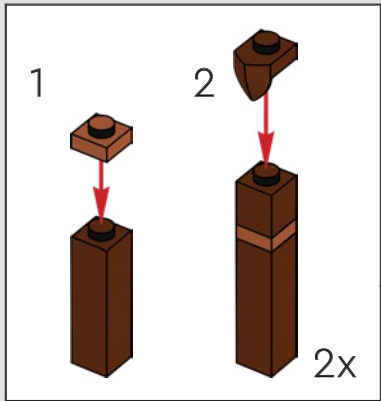
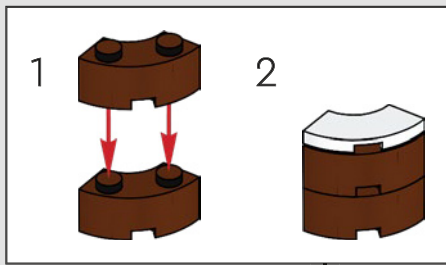

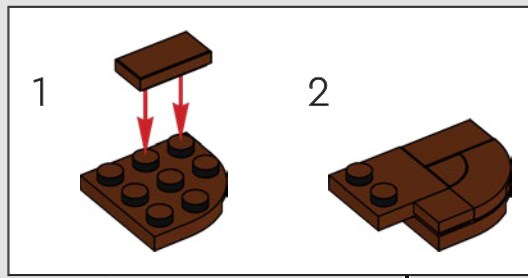
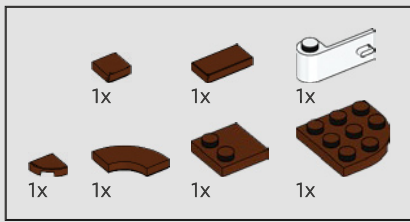

174

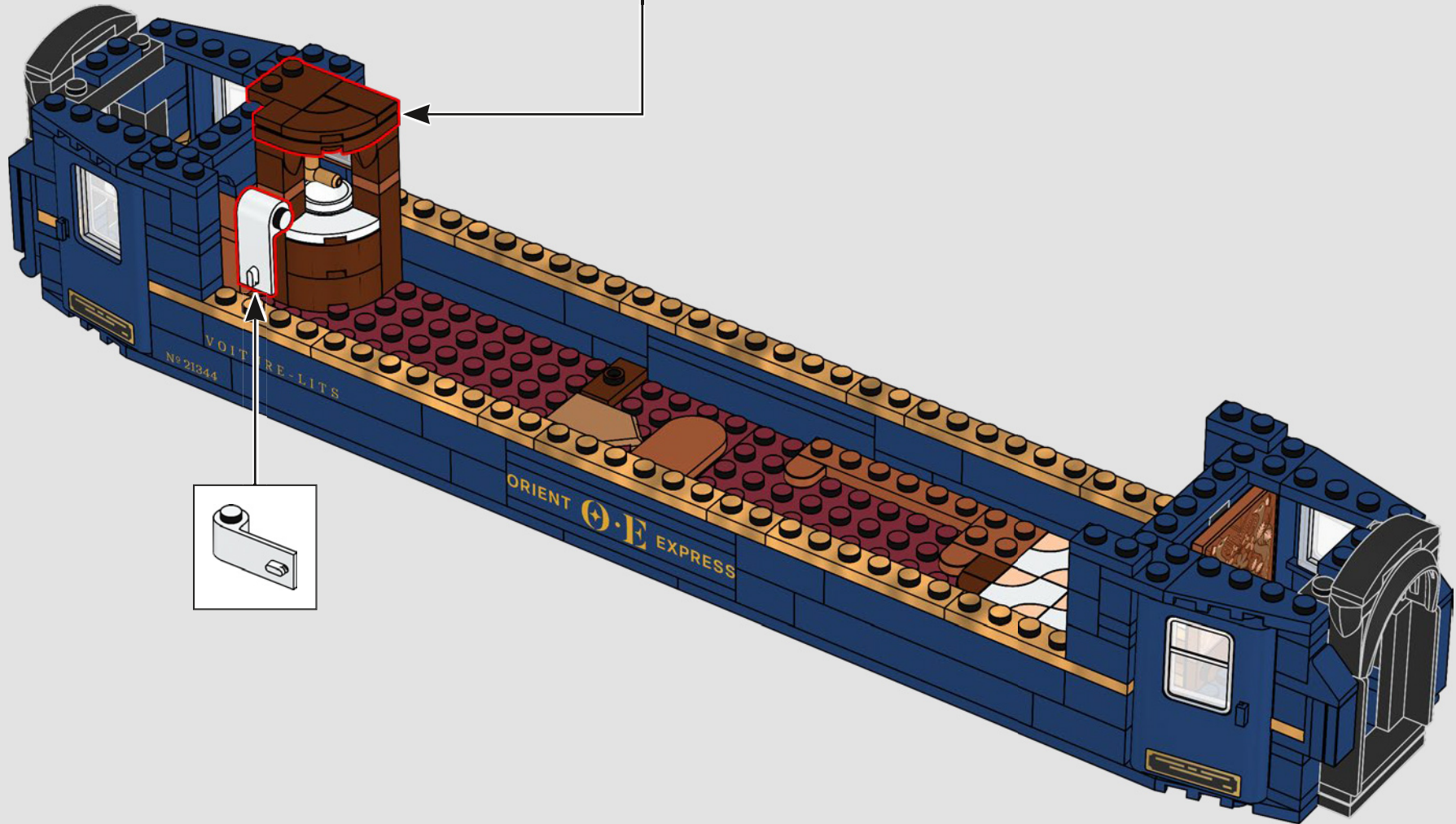



175

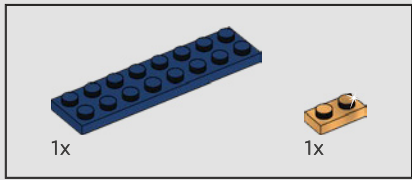
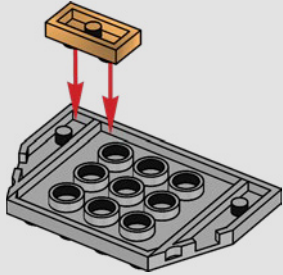

176

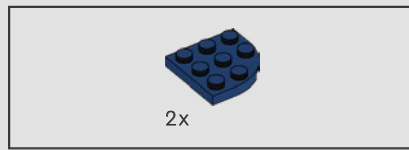
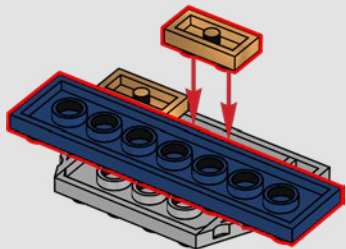

177

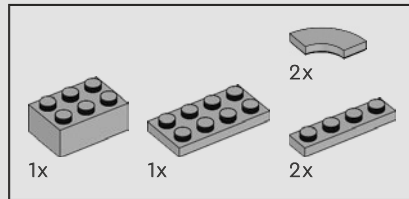
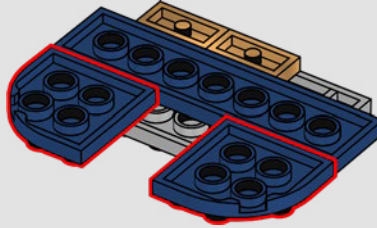

178

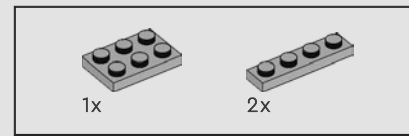
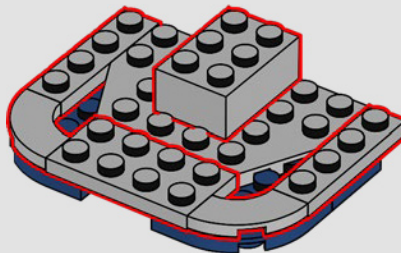
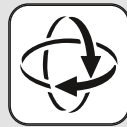

179

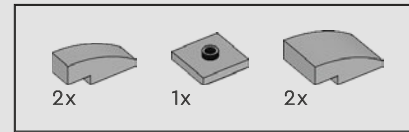
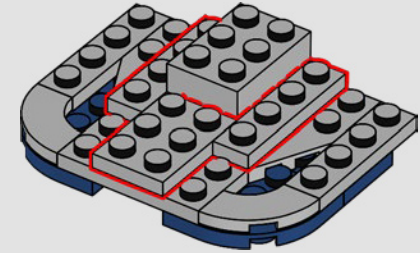

180

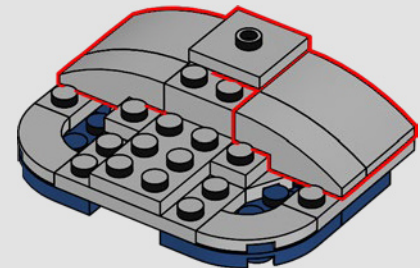

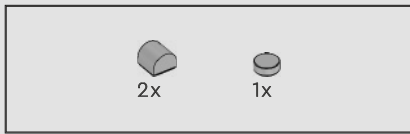

181

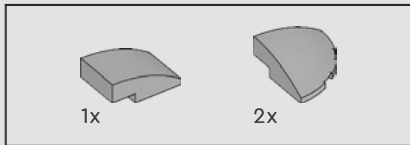
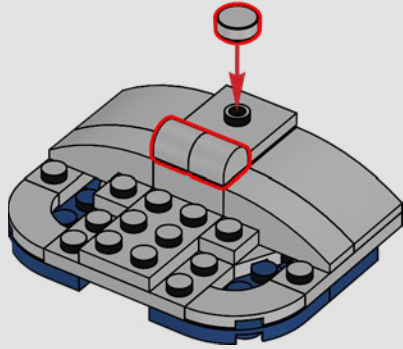

182

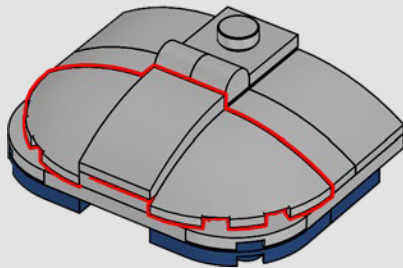

183

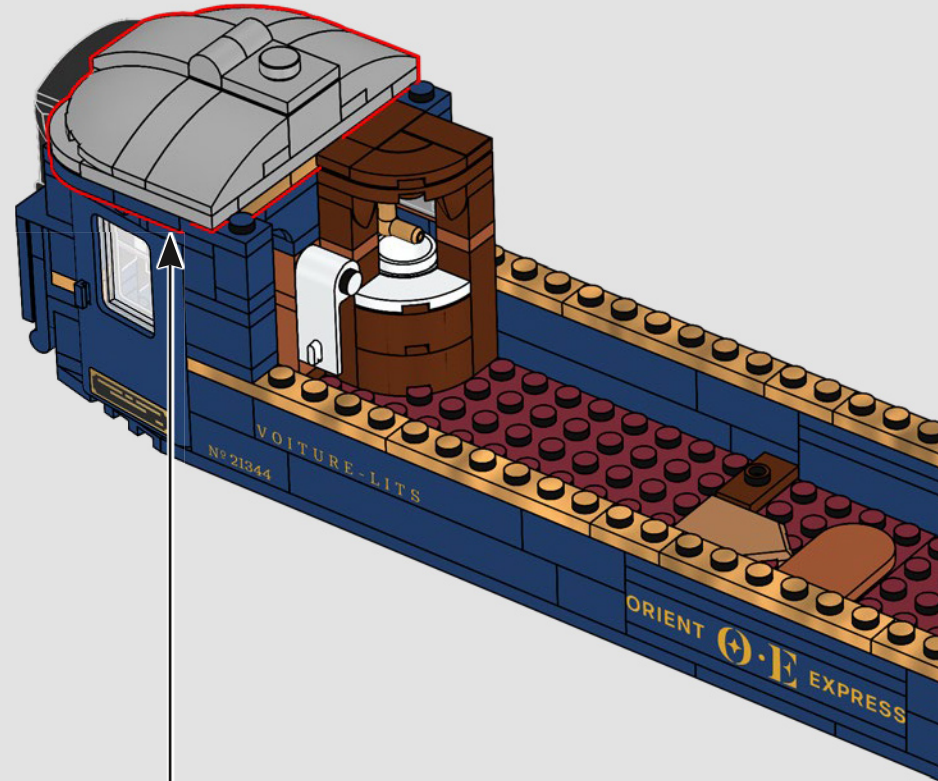

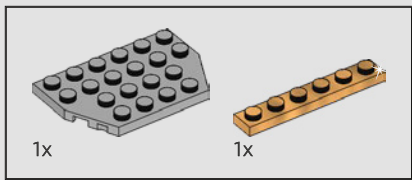

184

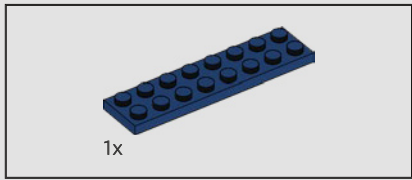
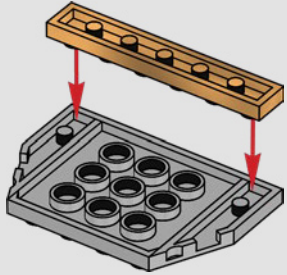

185

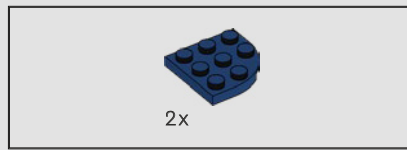
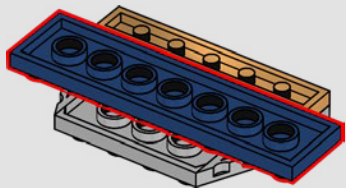

186

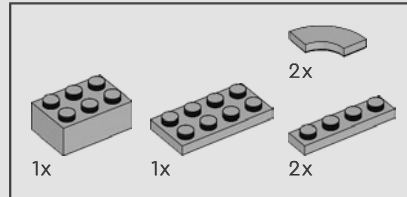
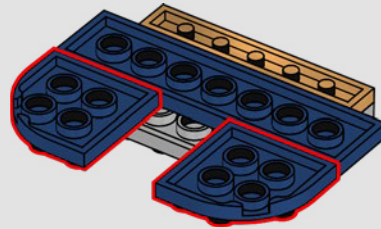

187

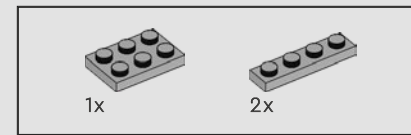
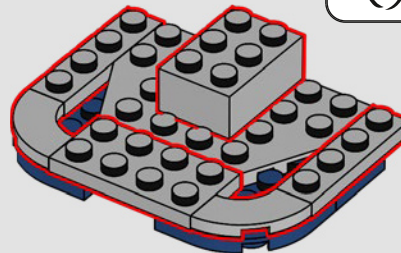

188

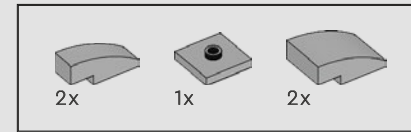
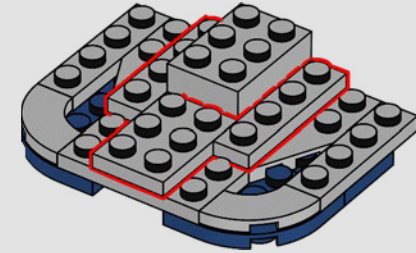

189

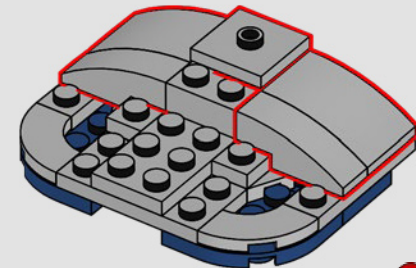

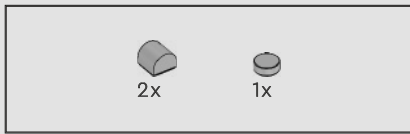

190

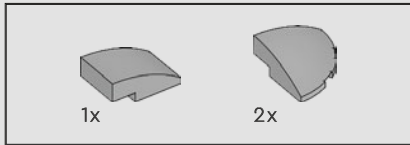
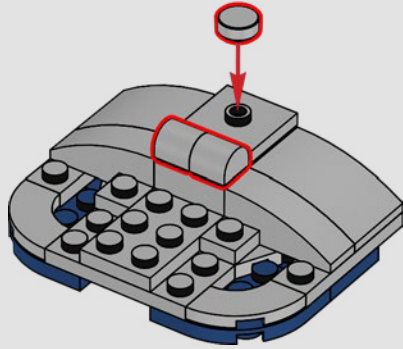

191

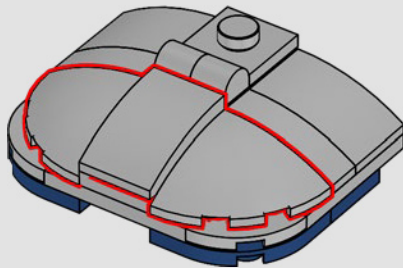

192

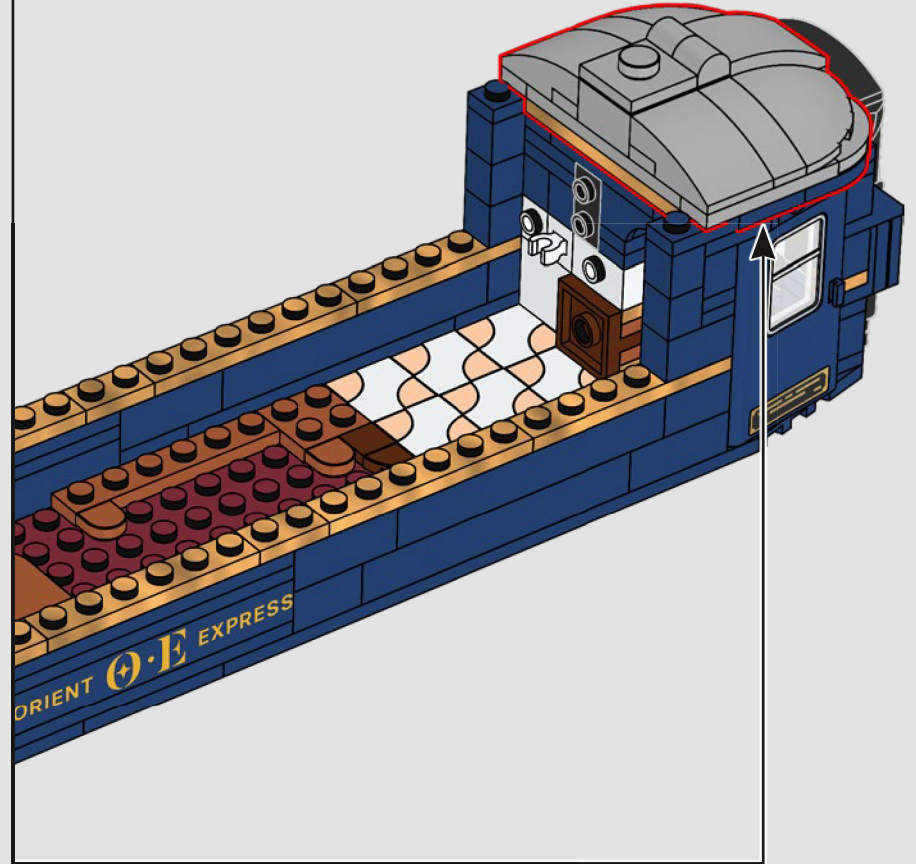

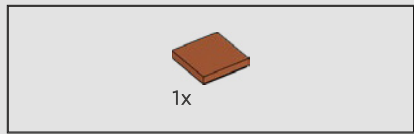

193

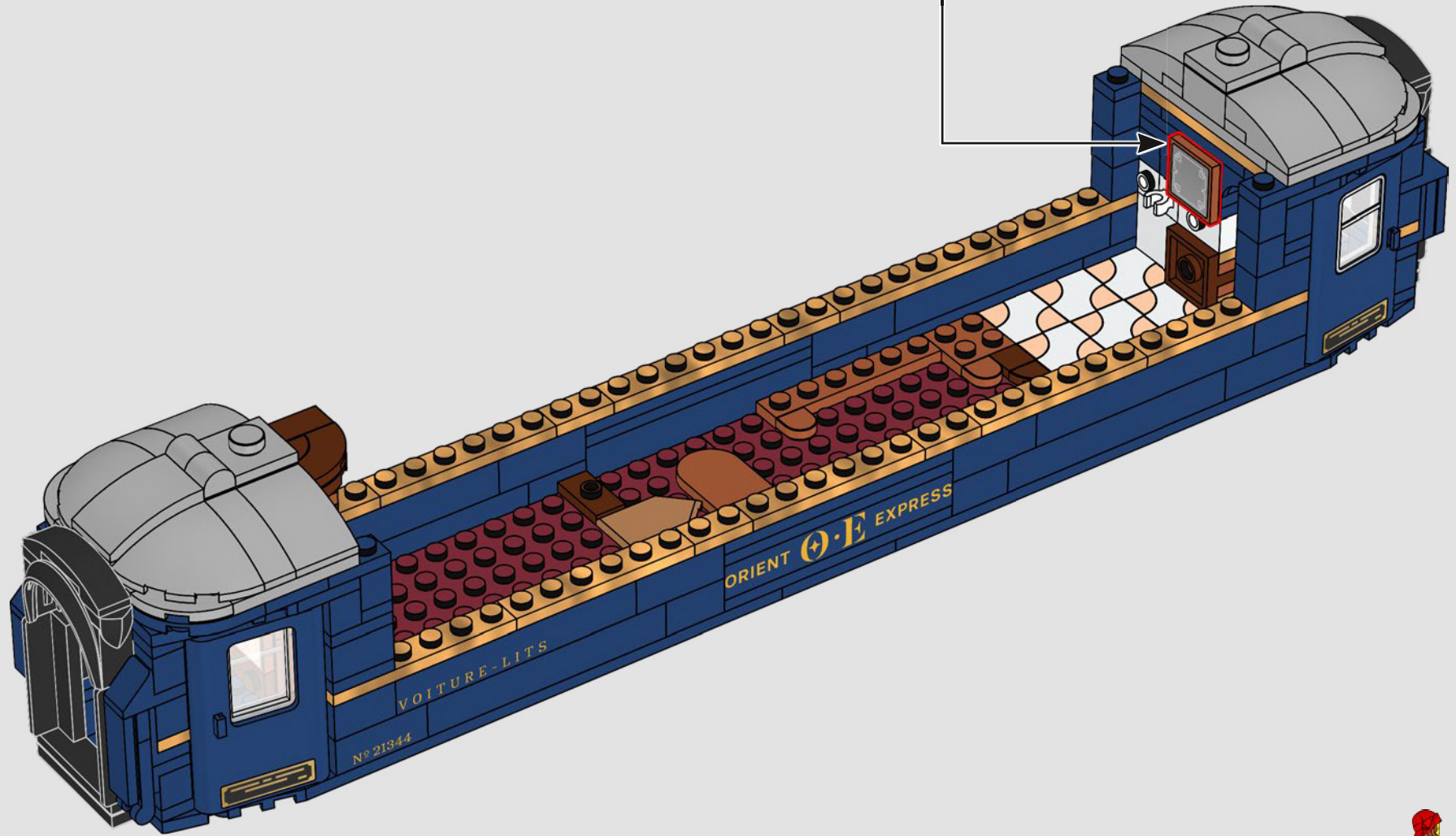
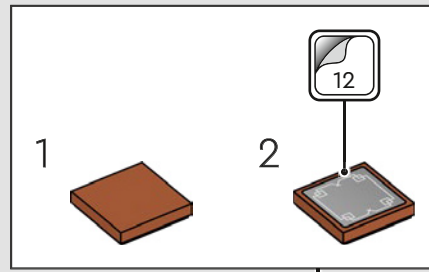

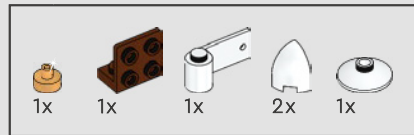

194

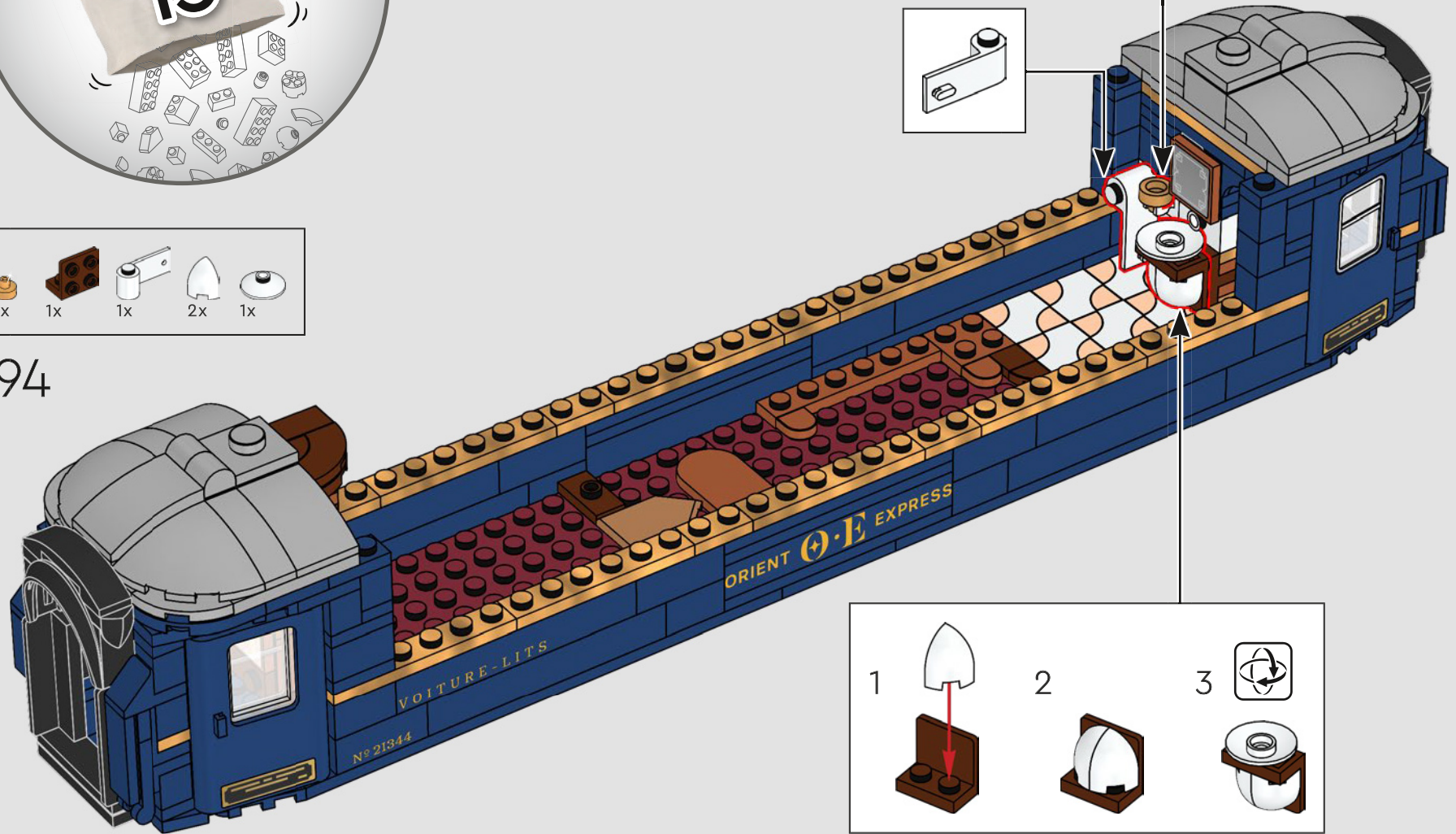

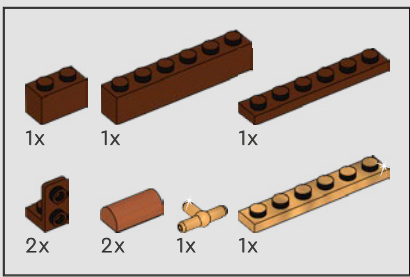

195

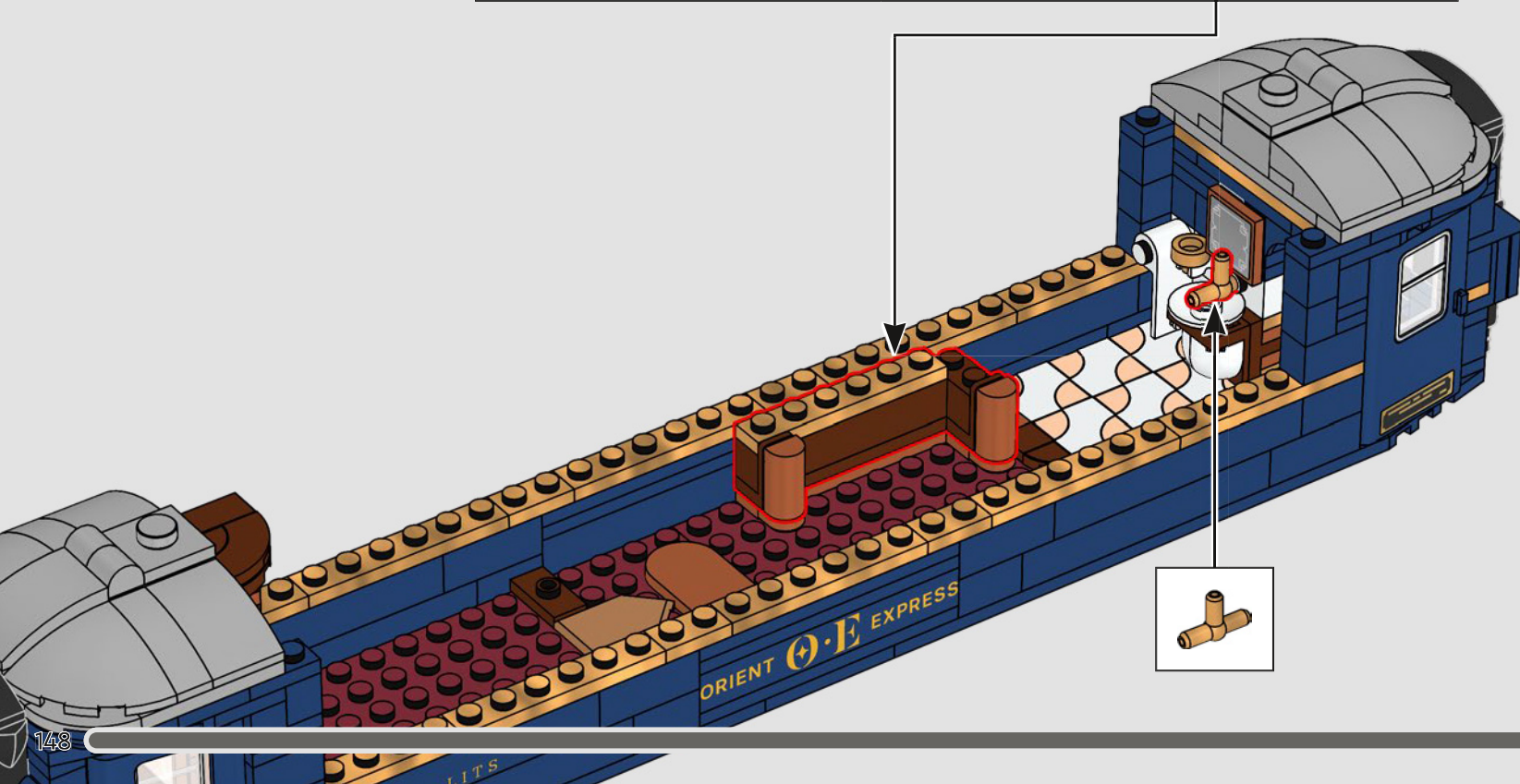
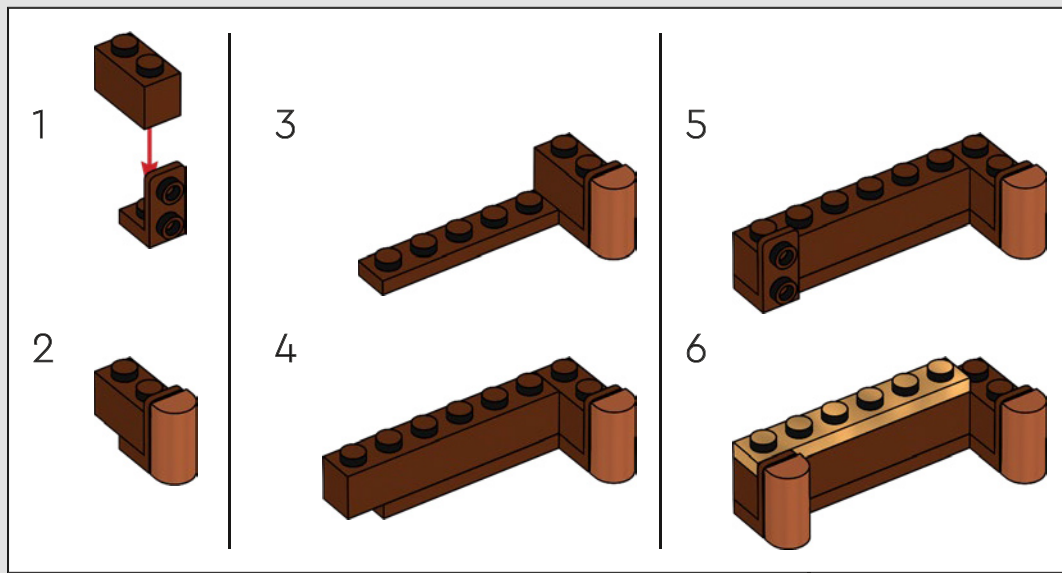

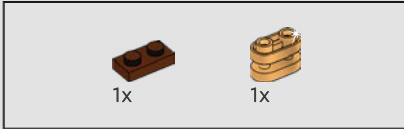
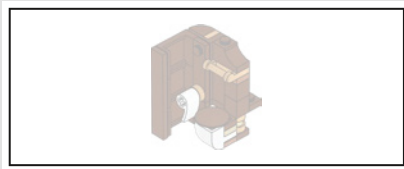

196

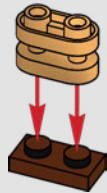

197



198

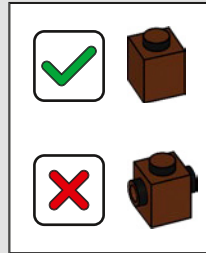

199

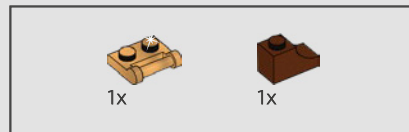
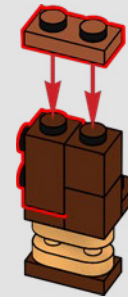
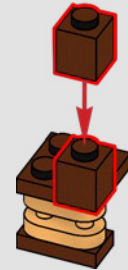

200



201

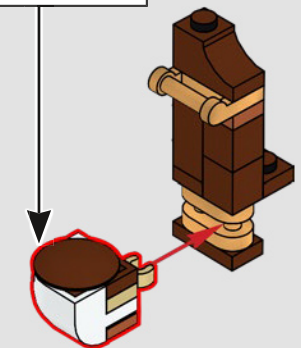
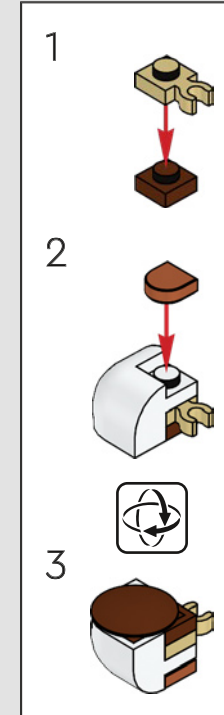

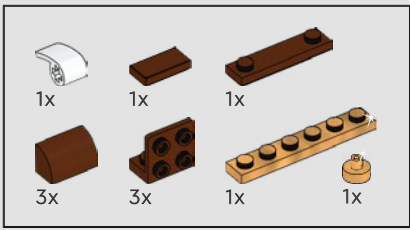

202

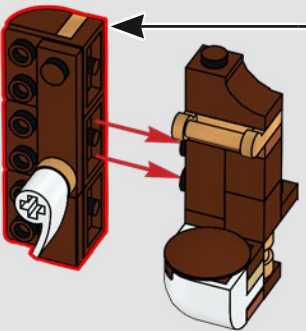
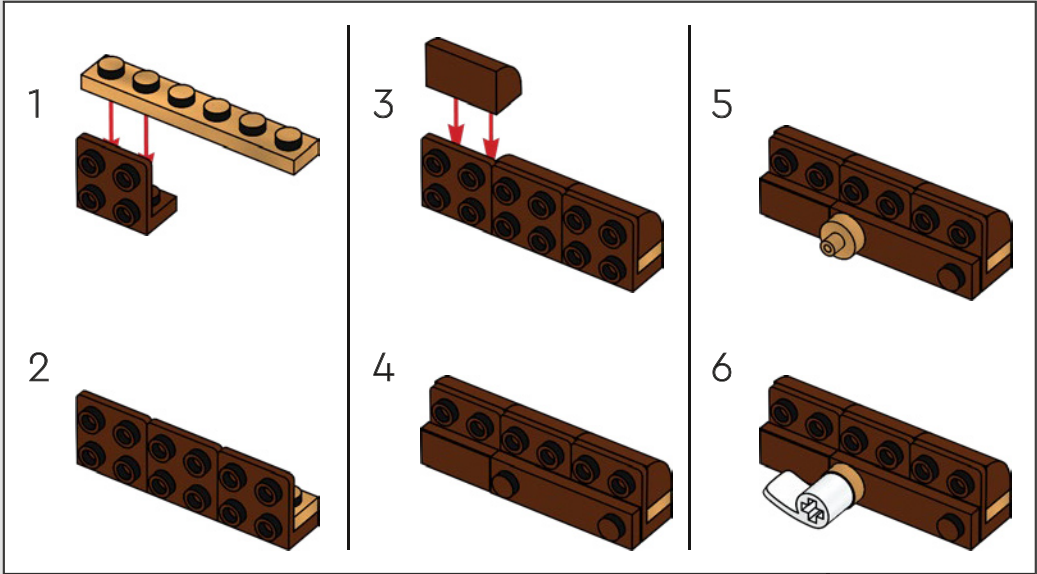

203

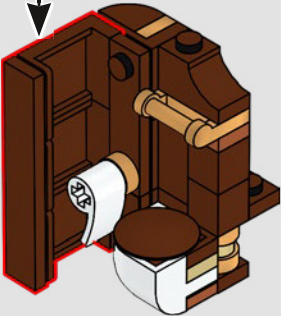
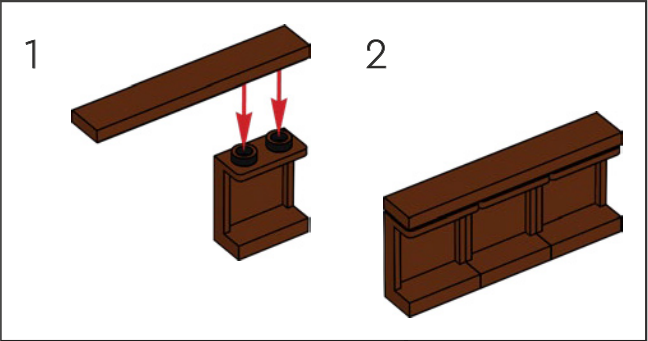

204

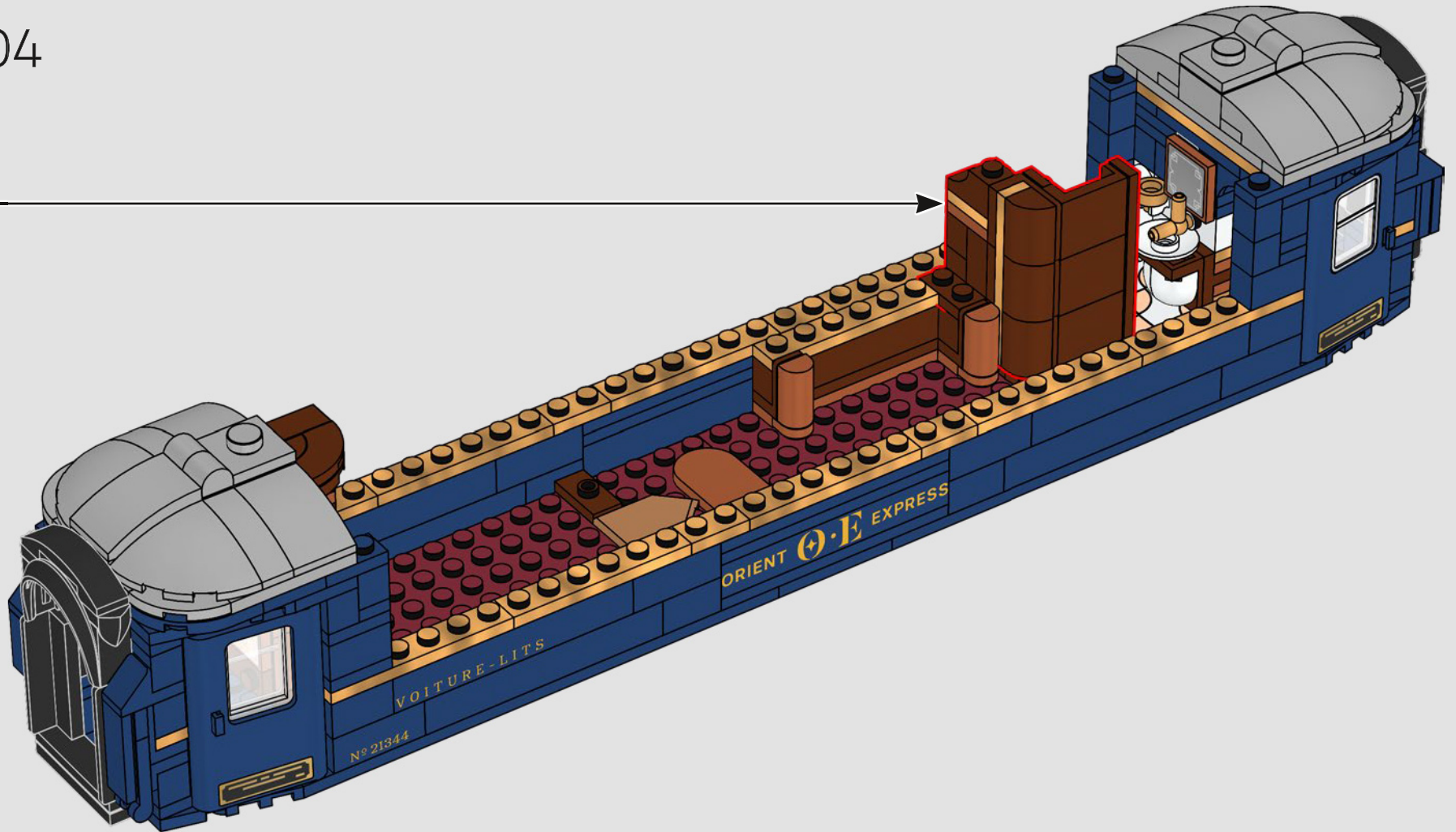

“头等车厢设有贴着宜人瓷砖的套间浴室。”

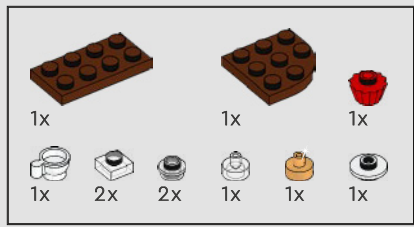

205

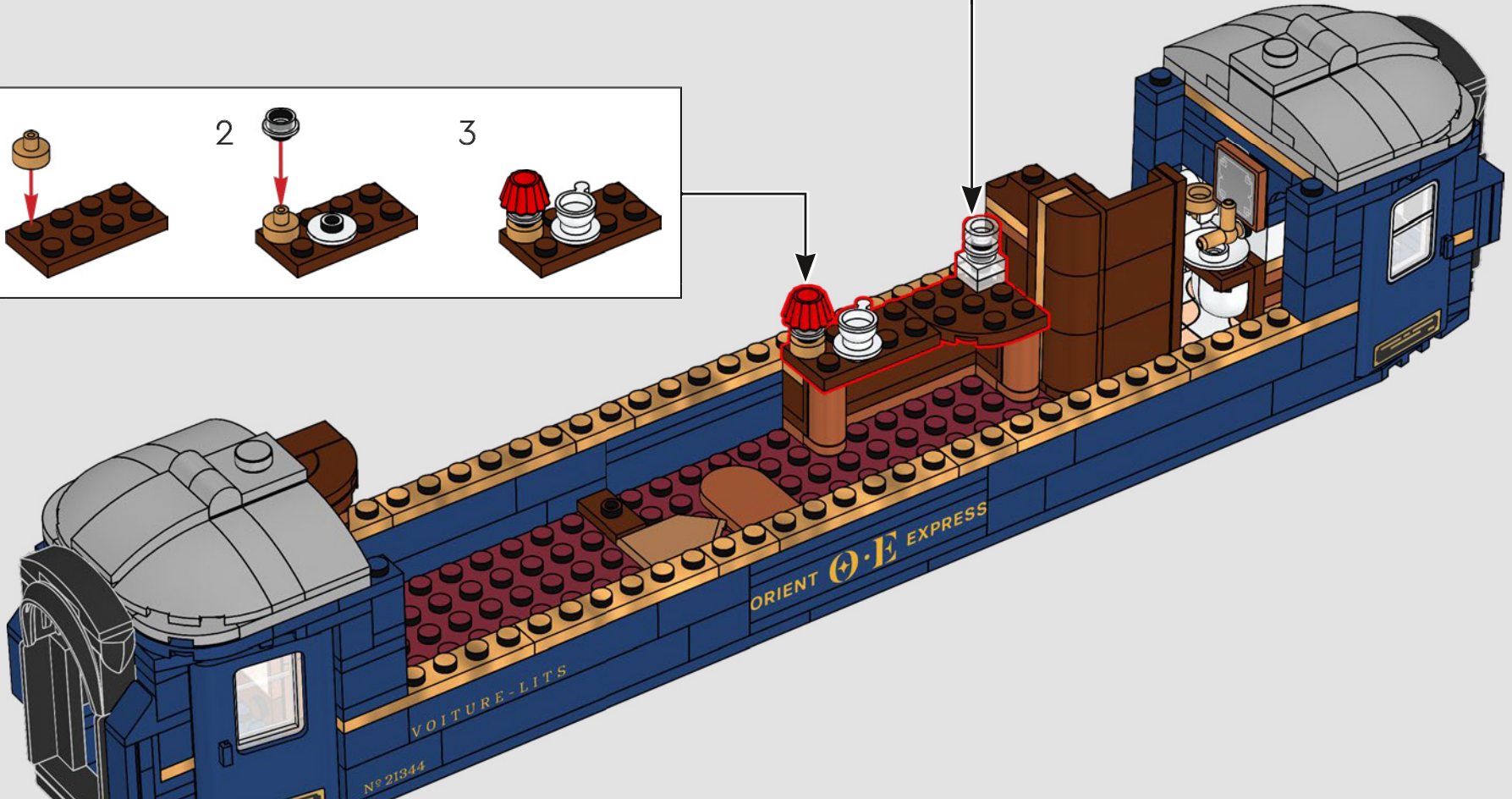
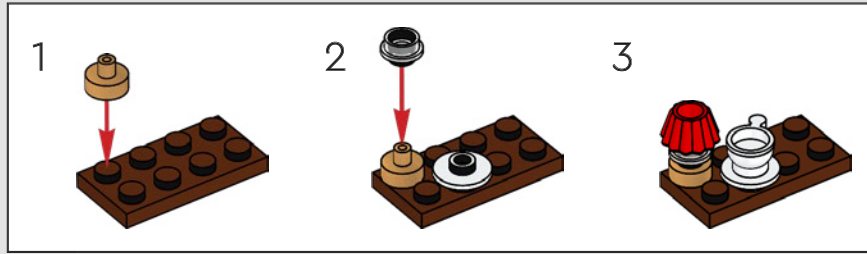
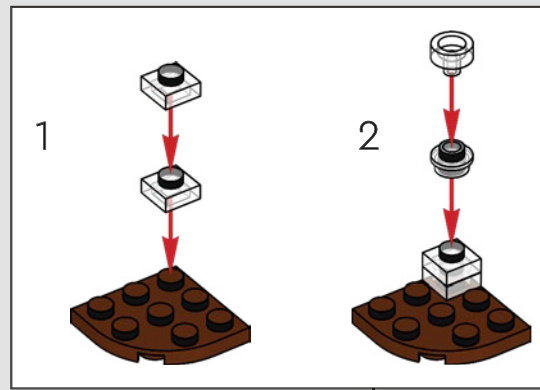

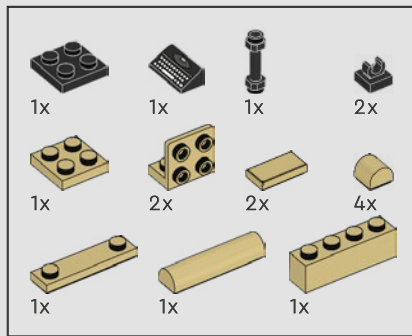

206

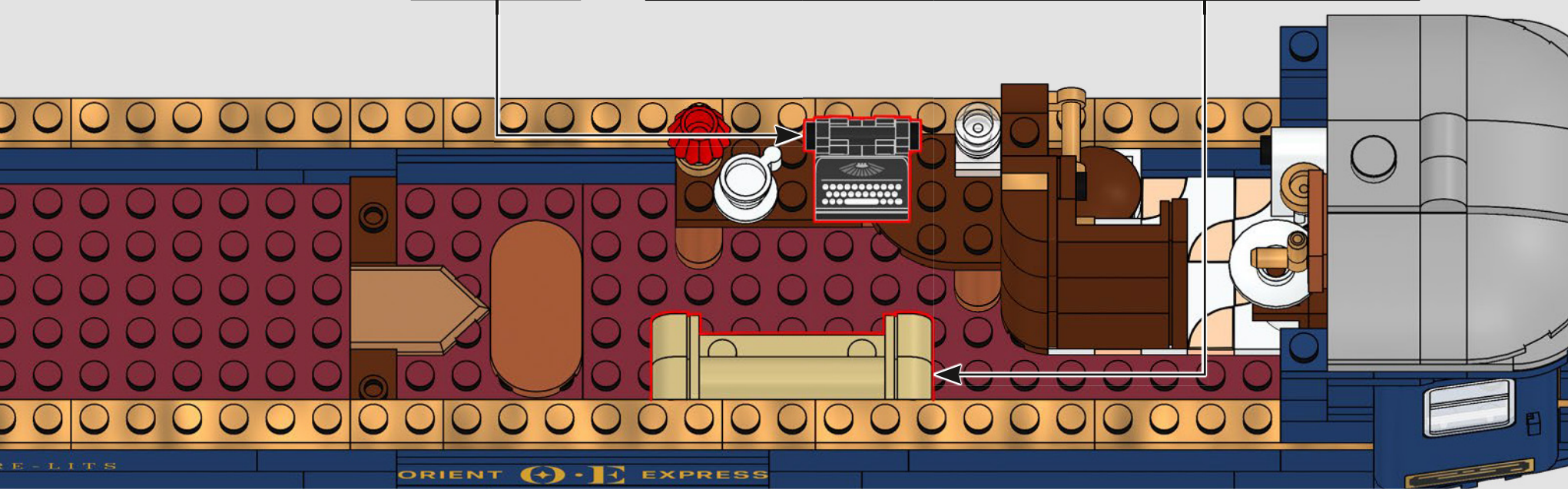
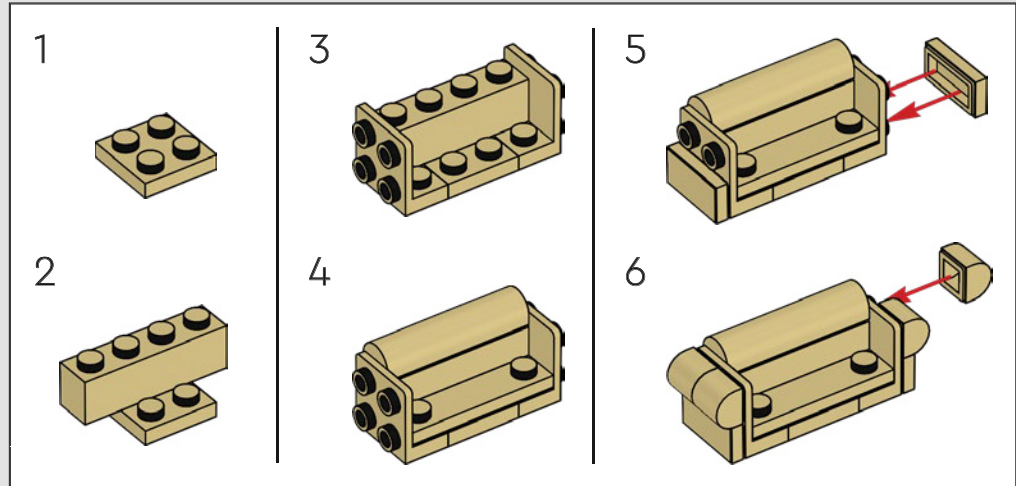
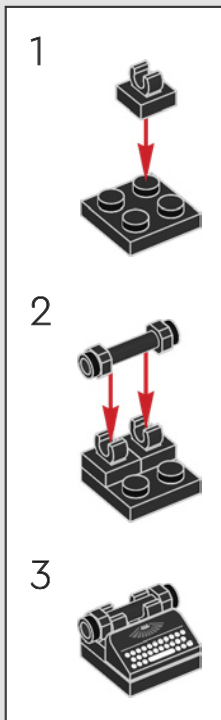

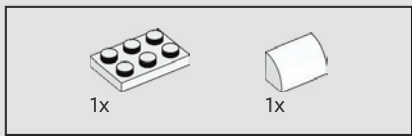

207

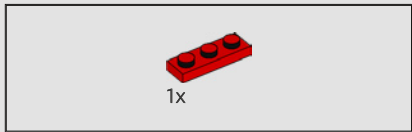
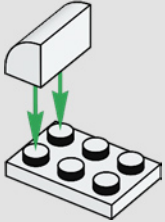

208

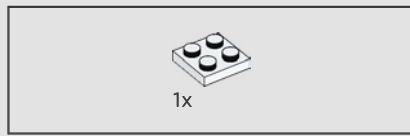
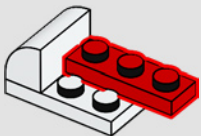

209

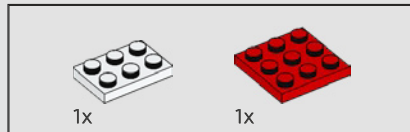
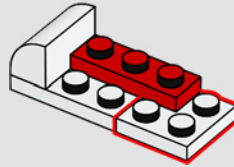

210

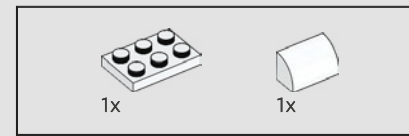
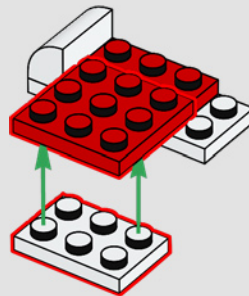

211

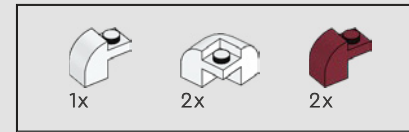
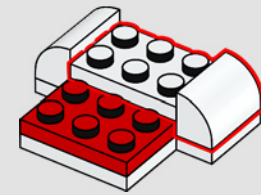

212

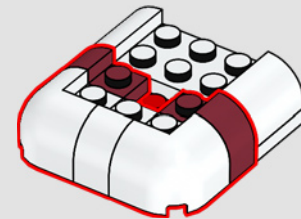

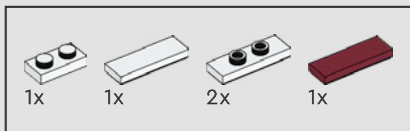

213

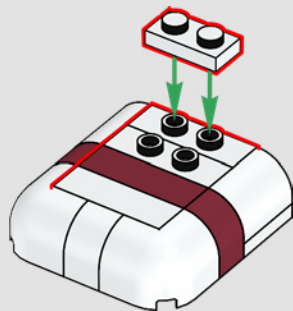

214

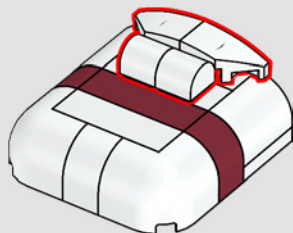

215

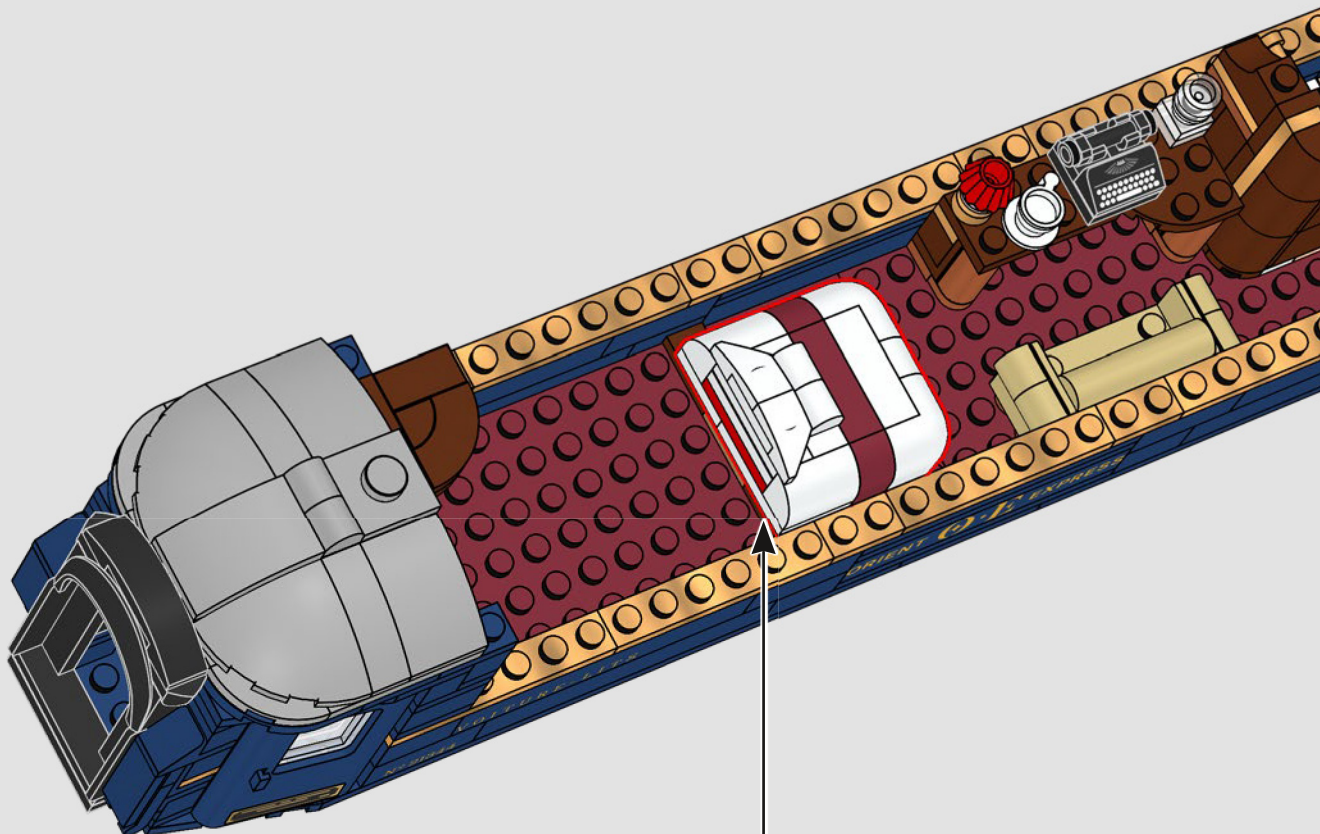

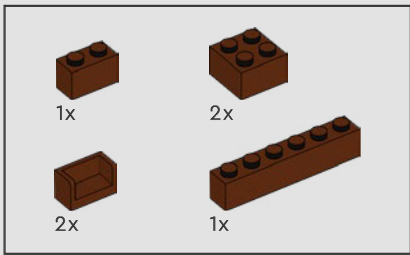

216

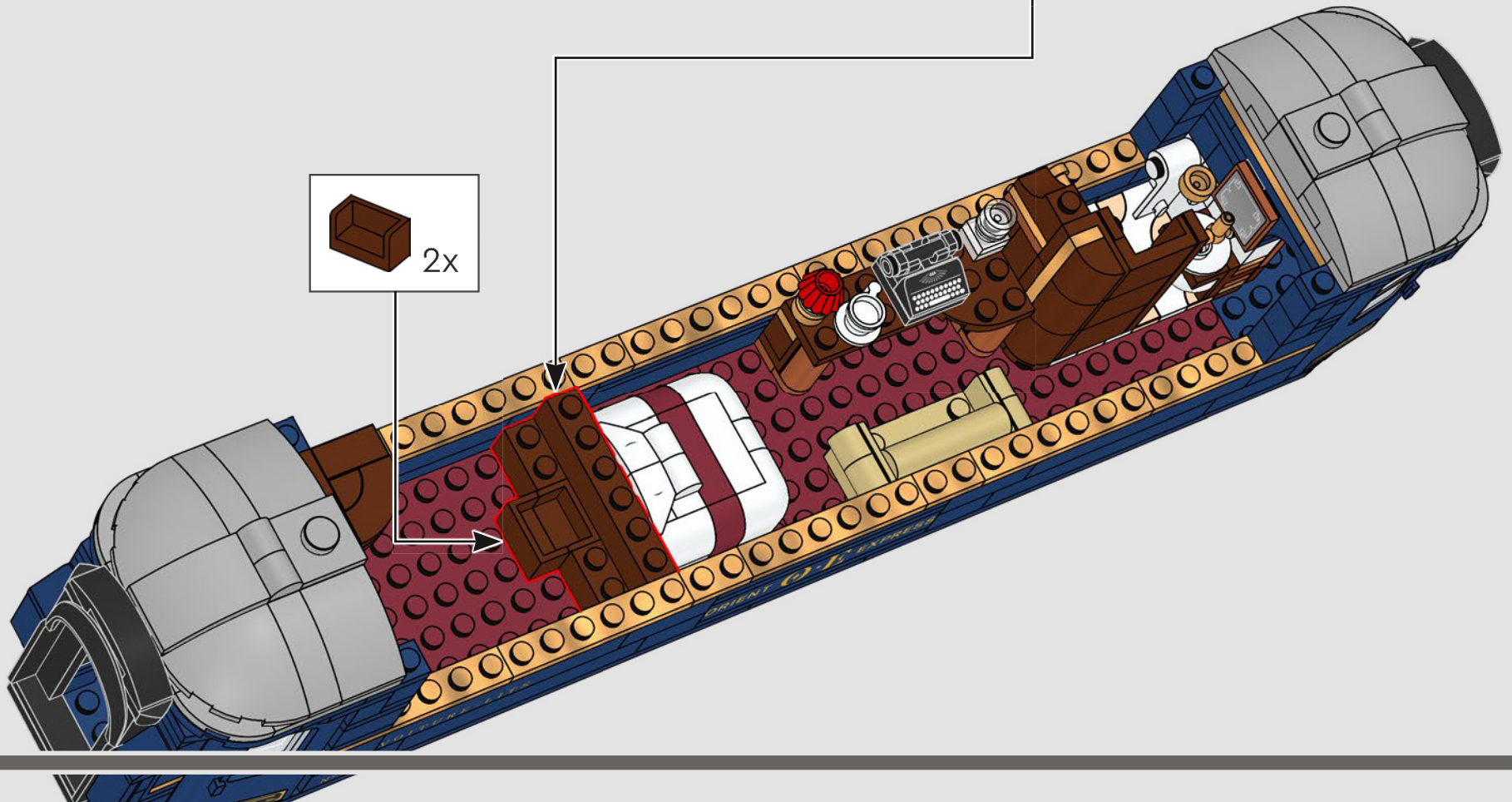
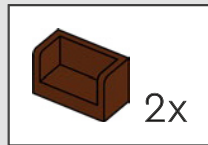
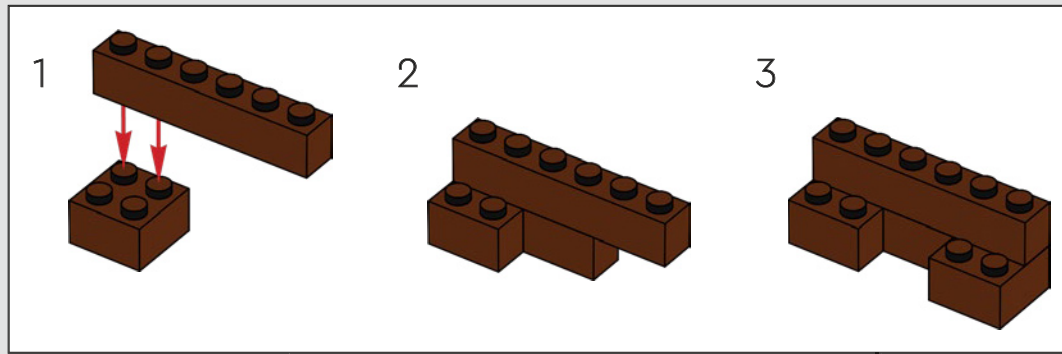



217

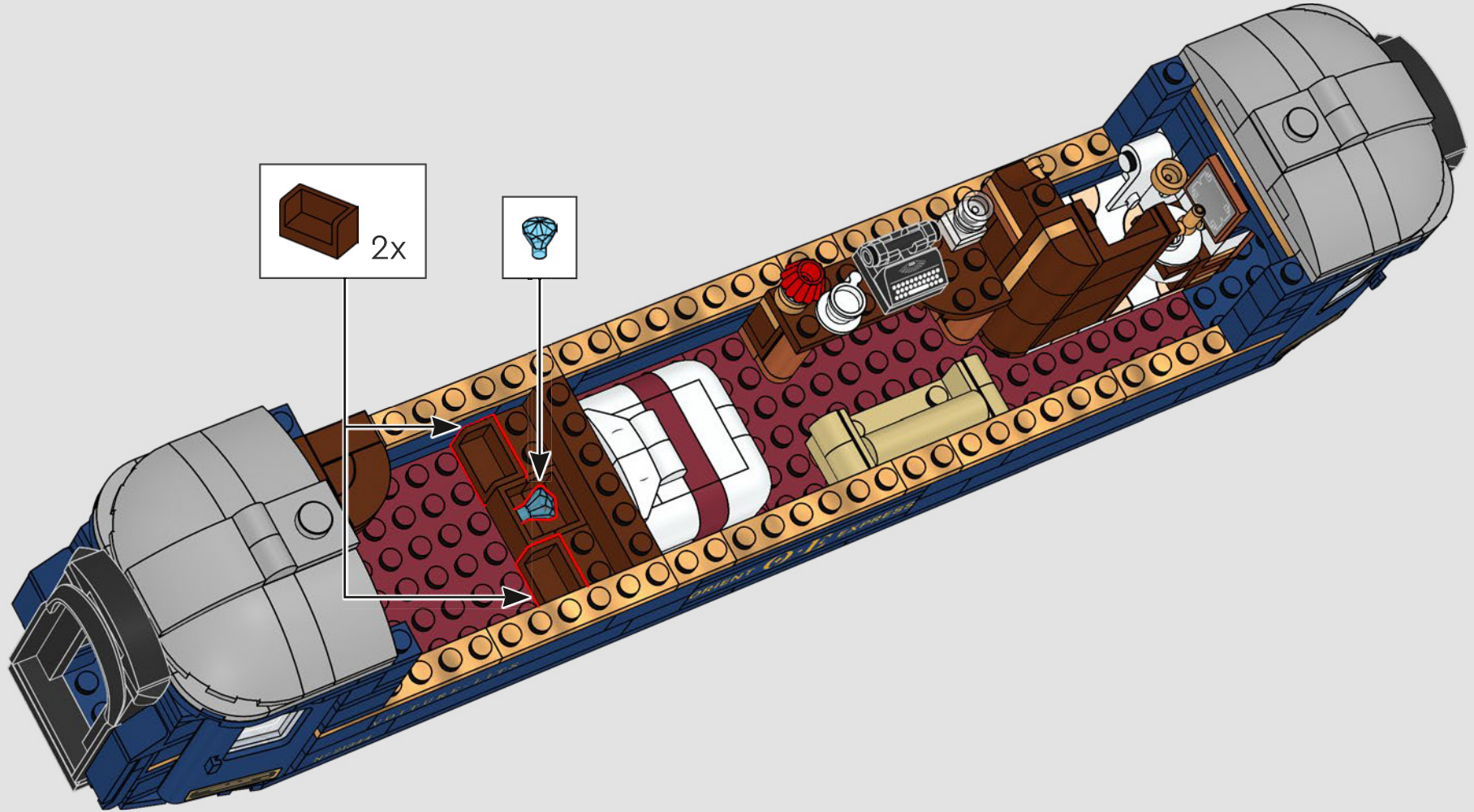

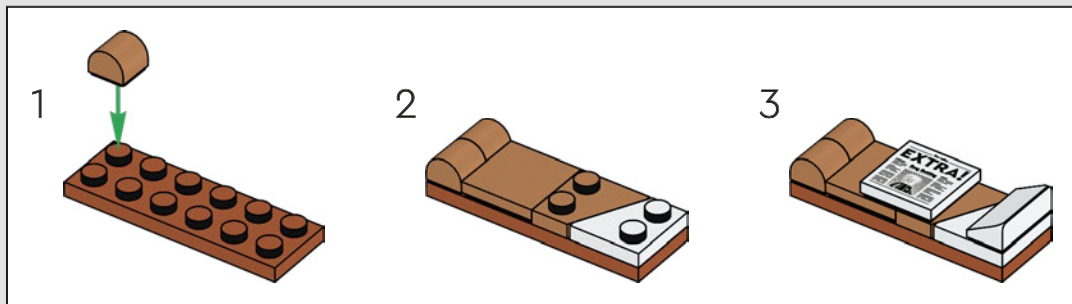
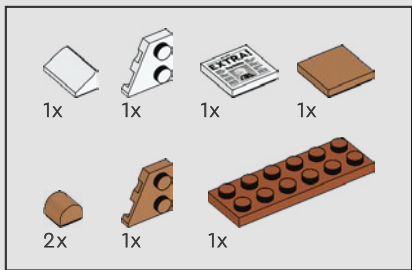

218

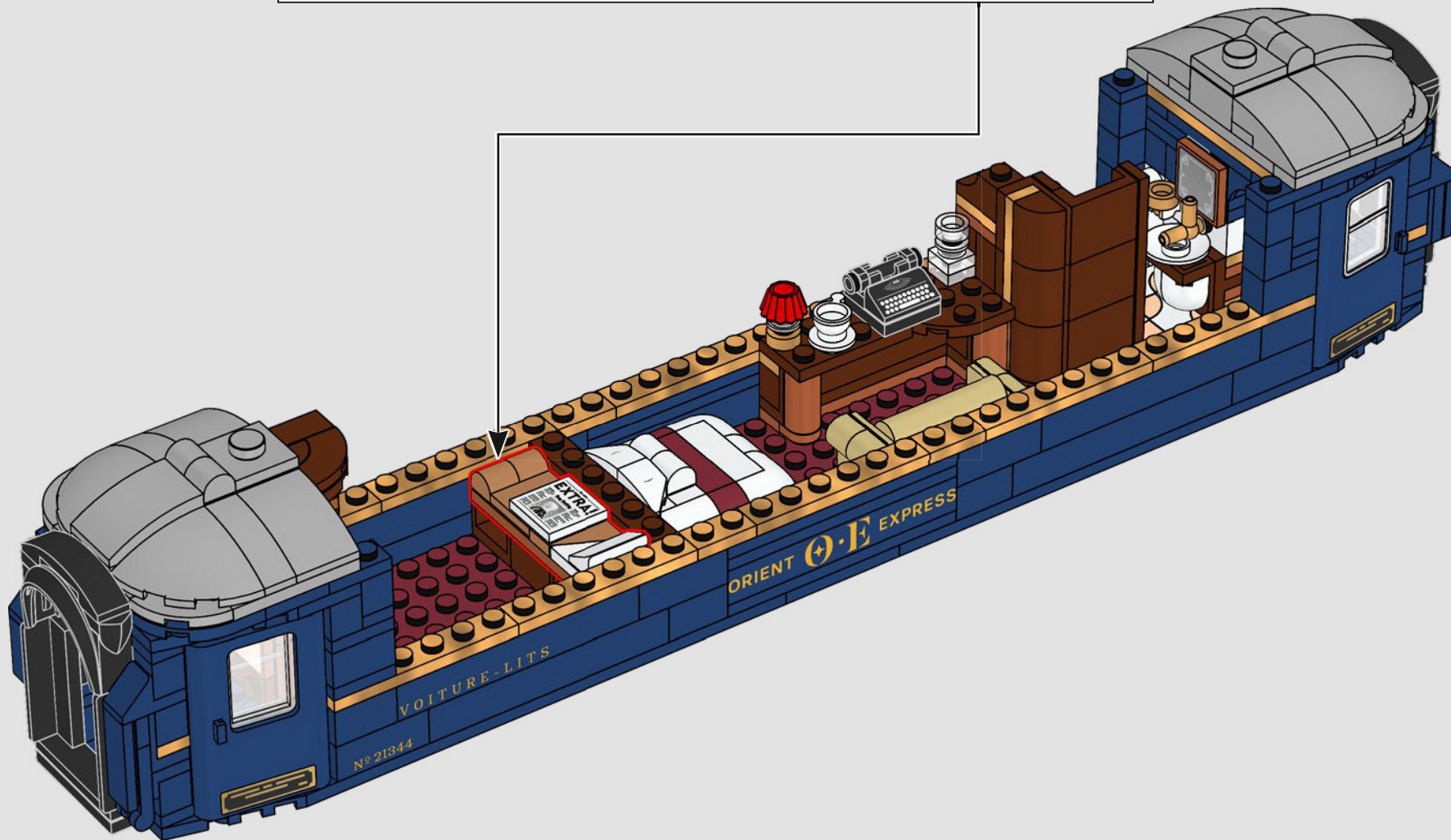



219

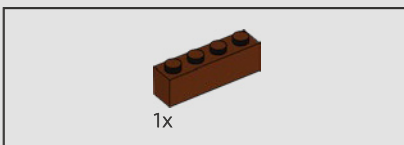
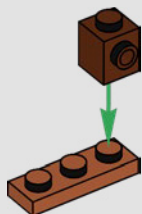

220

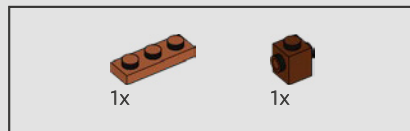
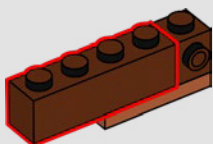

221

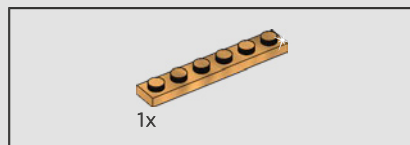
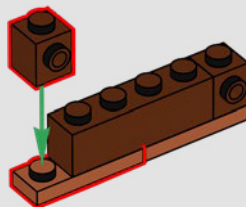

222

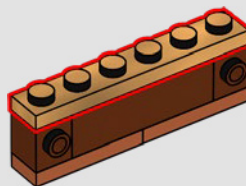

223

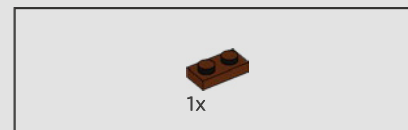
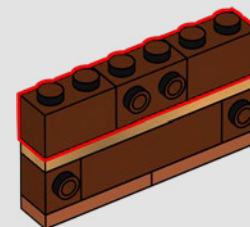

224

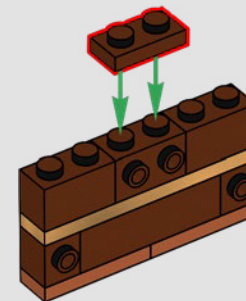



225

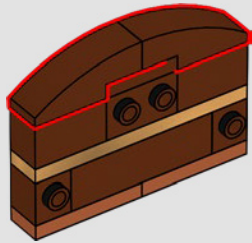

226

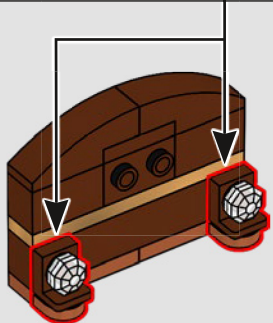
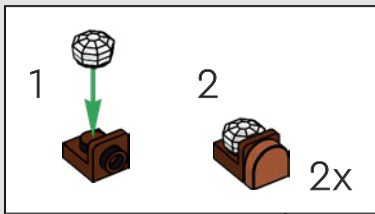

227

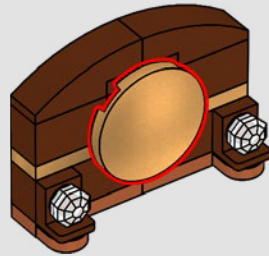

228

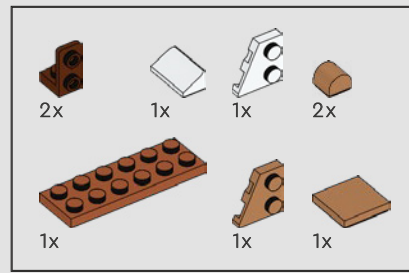
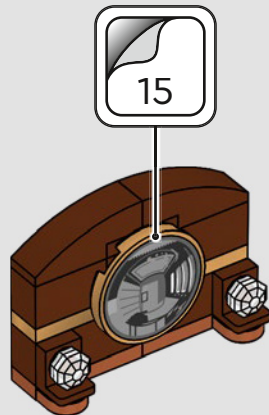

229

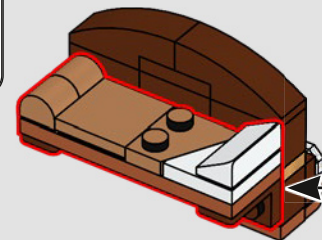
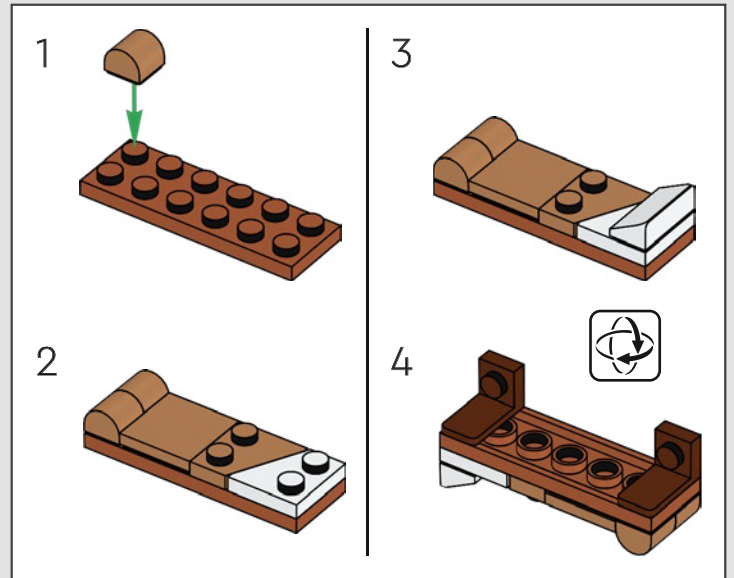

230

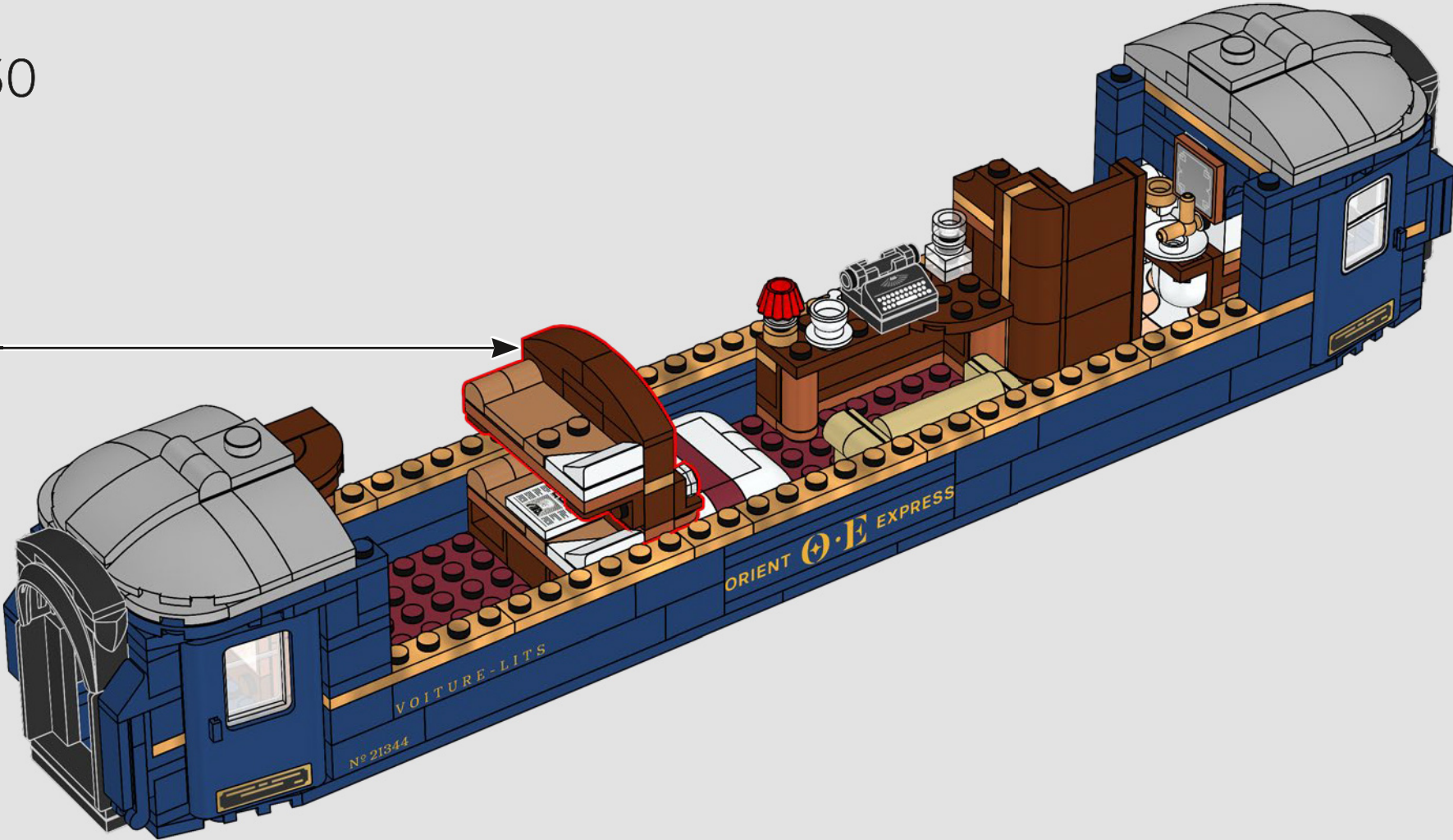

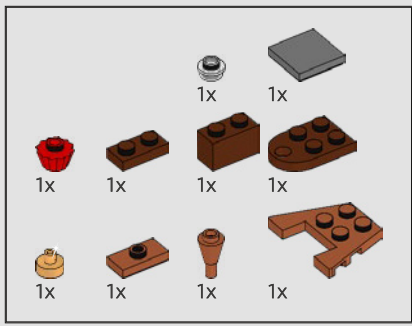

231

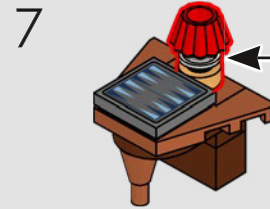
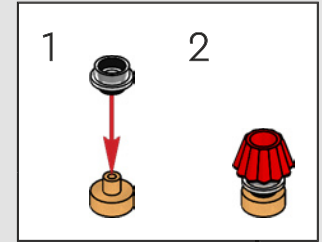
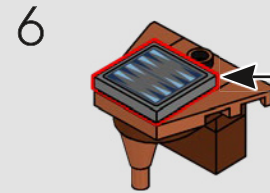
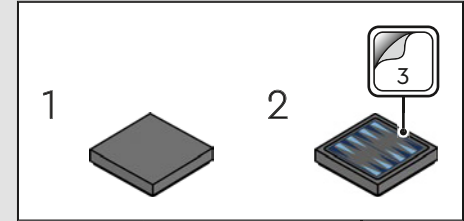
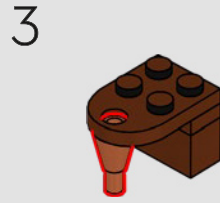
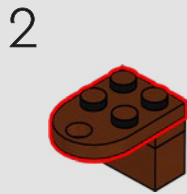
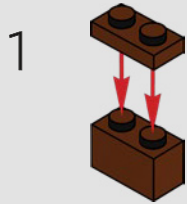

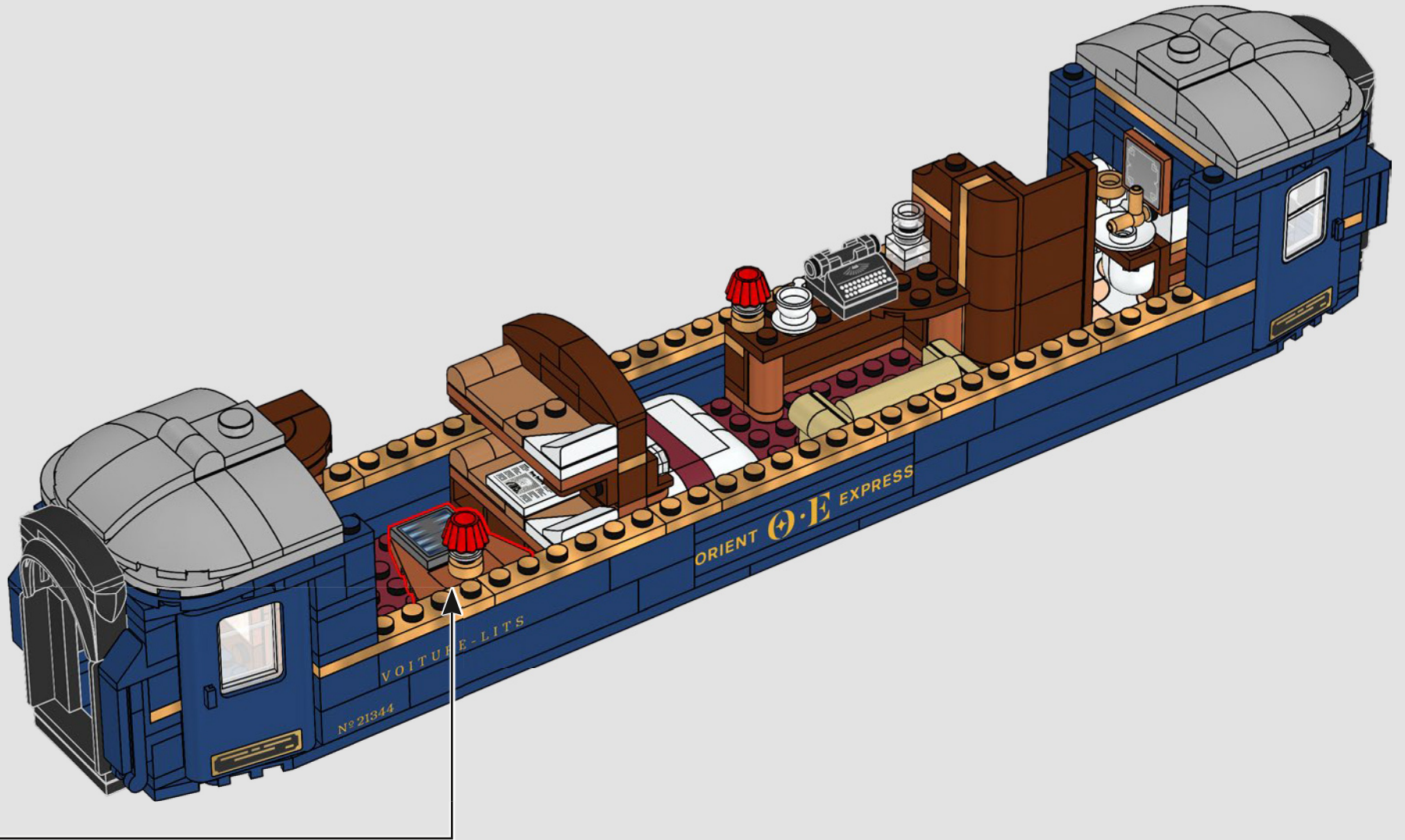



下一站:布加勒斯特
“这个充满活力的城市是我们的下一站。
林荫大道上熙熙攘攘,热闹非凡。”

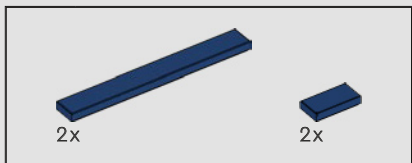

232

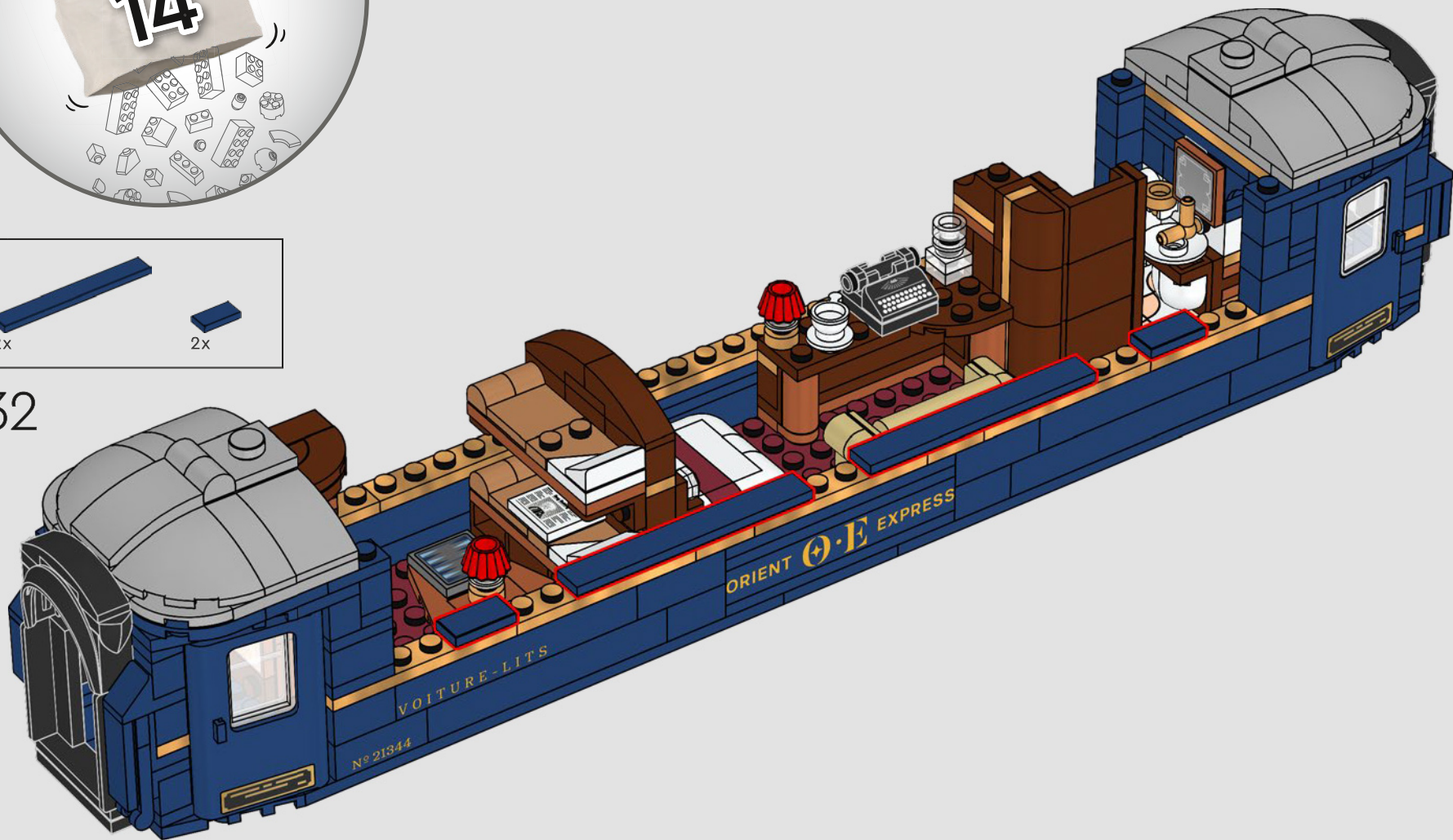

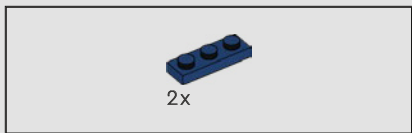

237

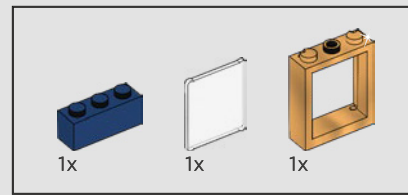
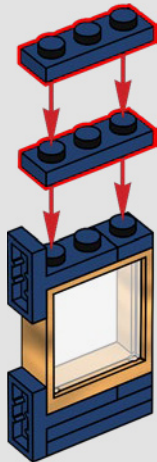

238

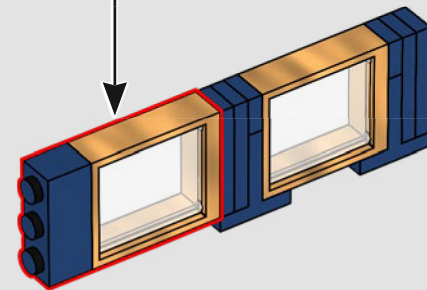
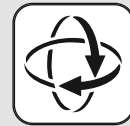
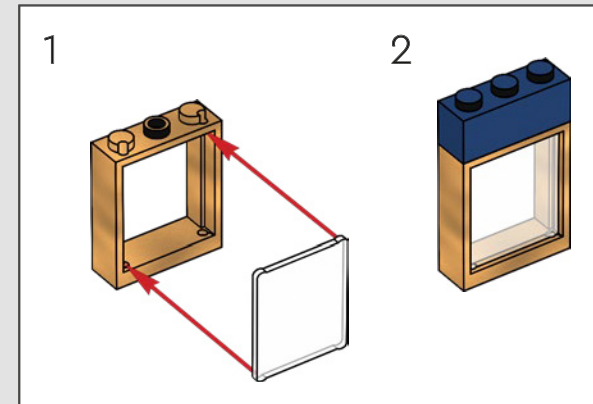

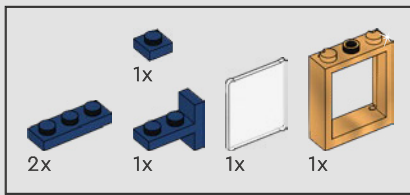

239

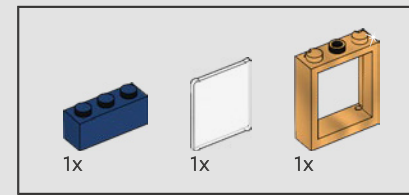
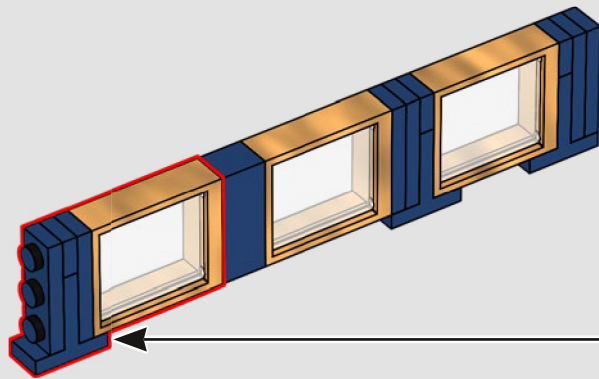
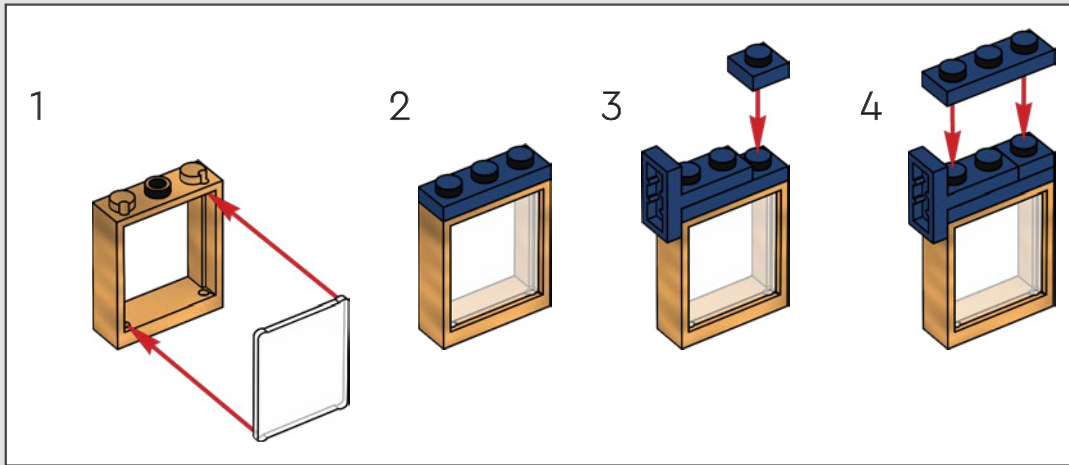

240

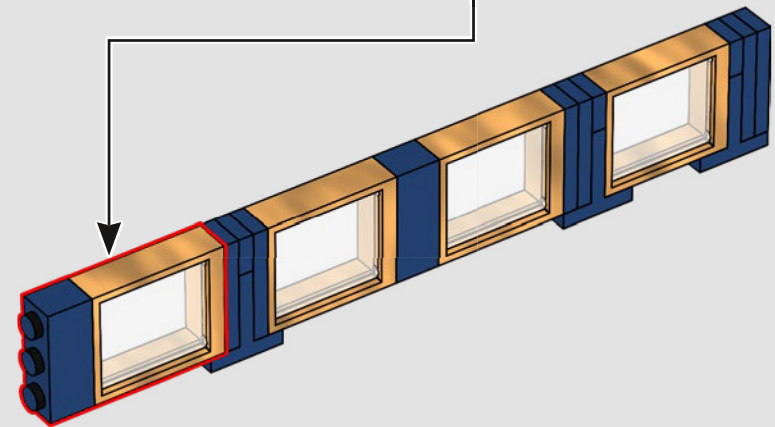
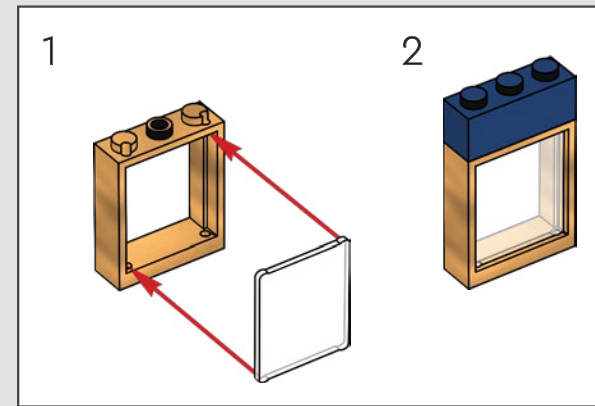

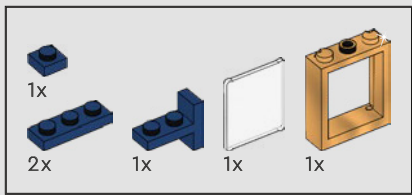

241

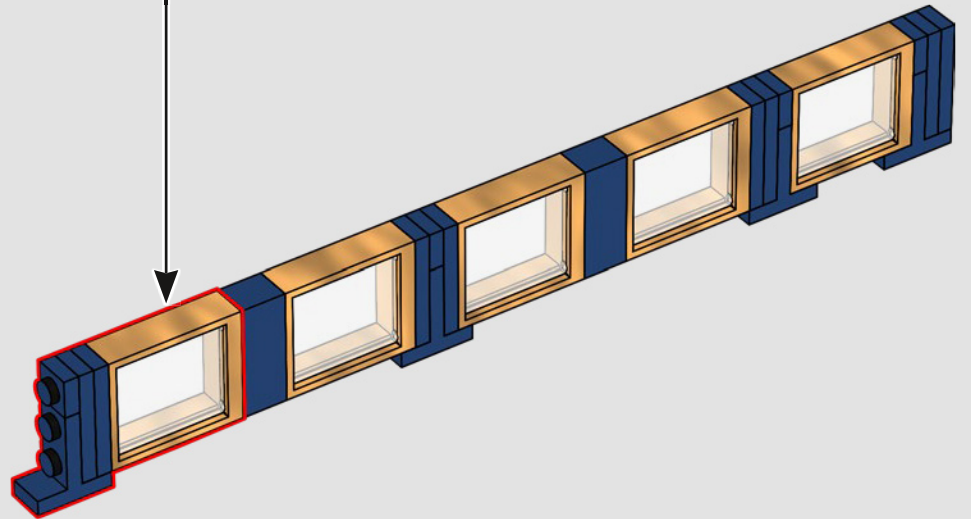
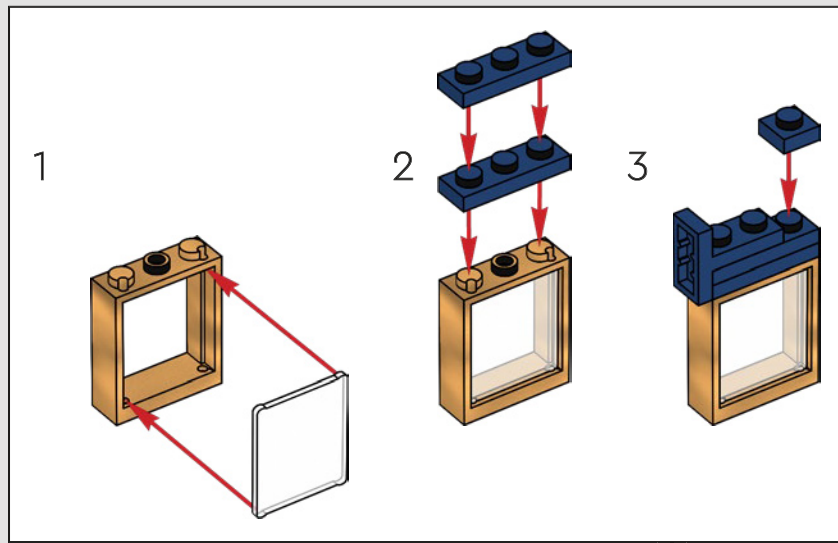

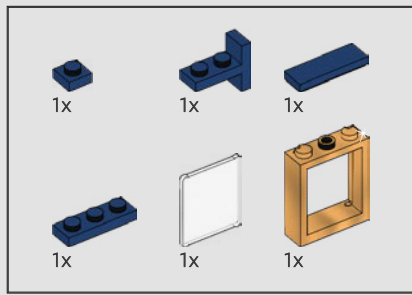

242

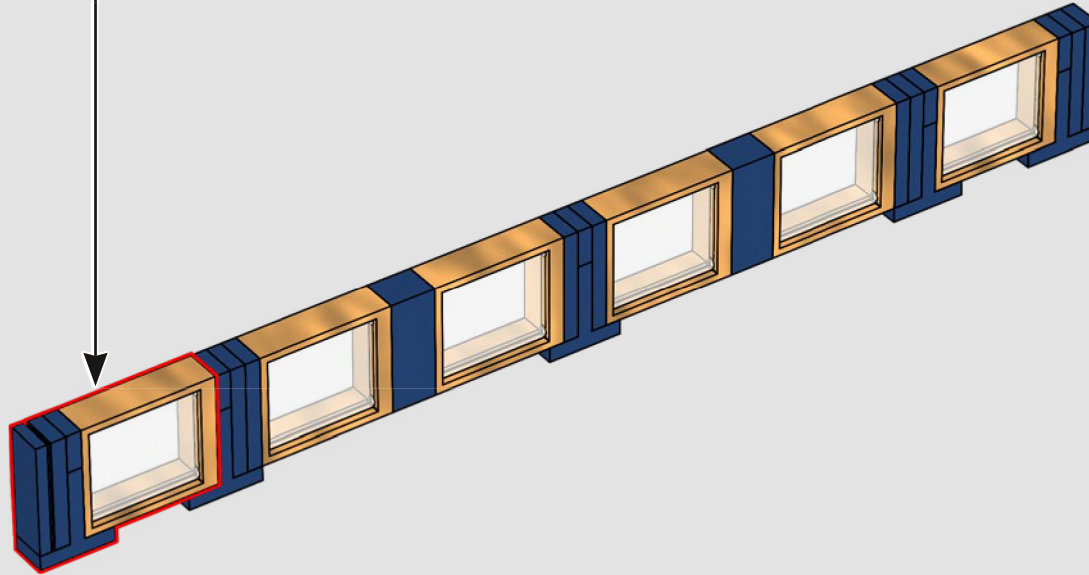
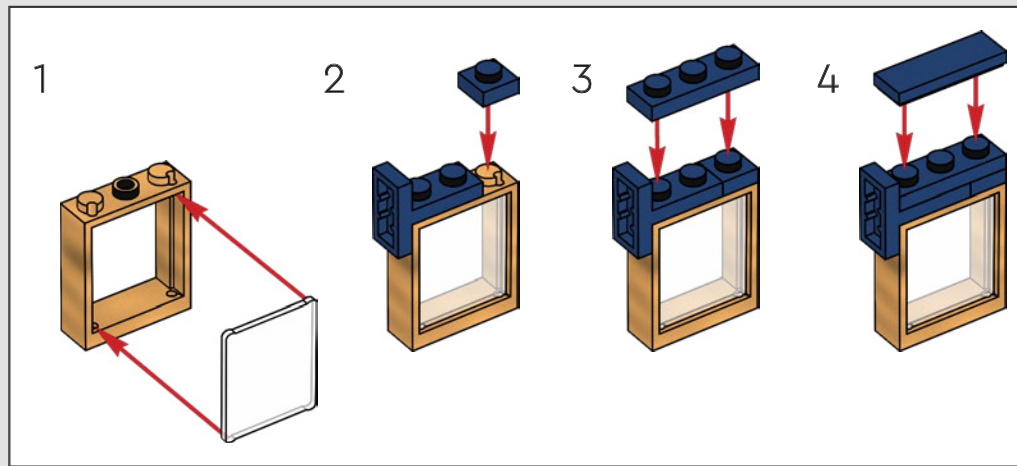

243

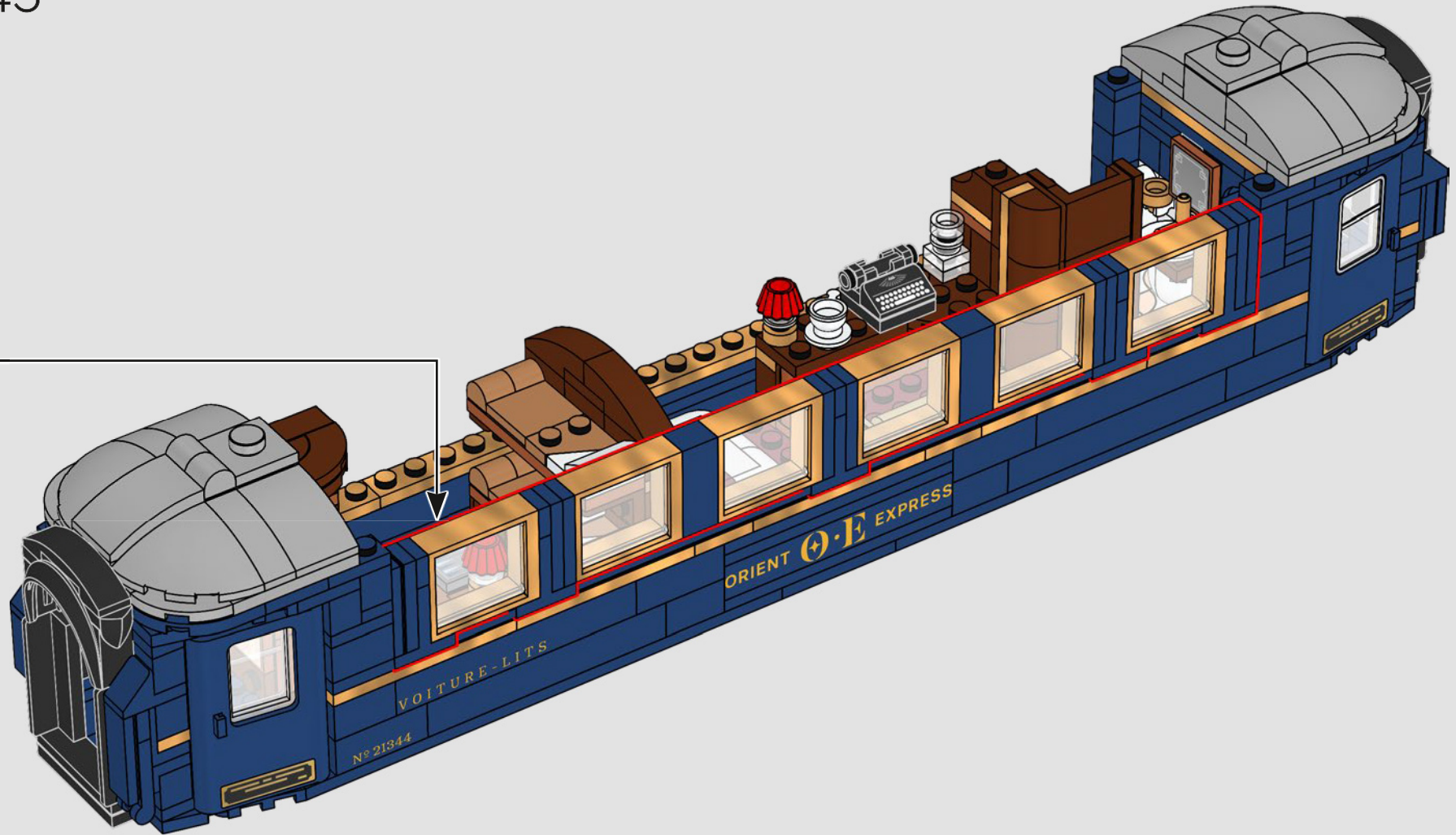

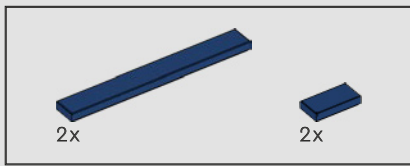

244

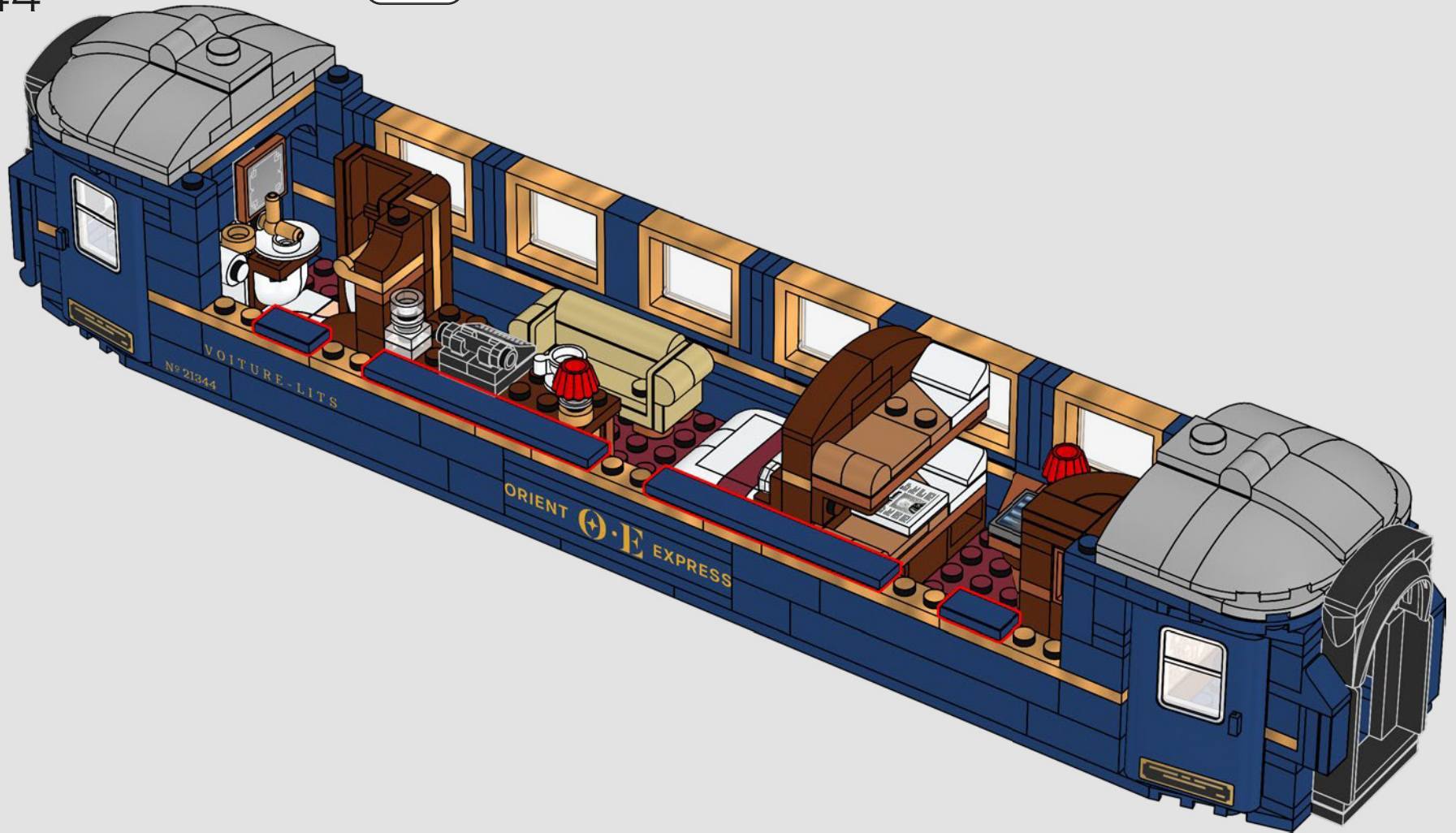

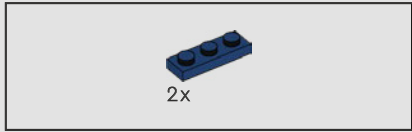
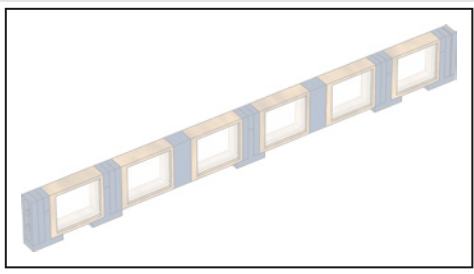

245

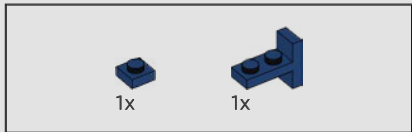
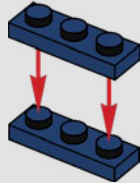

246

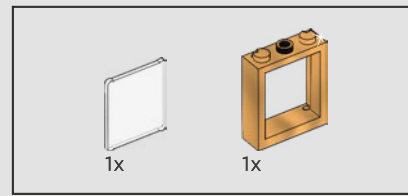
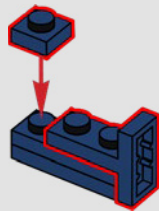

247

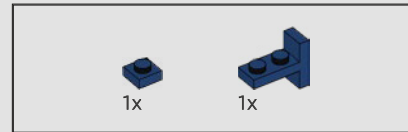
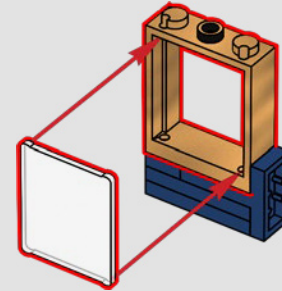

248

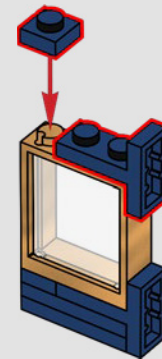

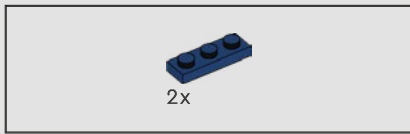

249

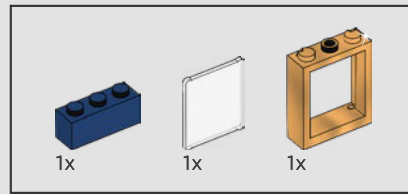
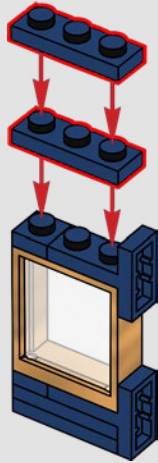

250

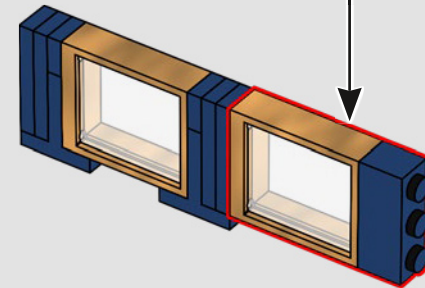
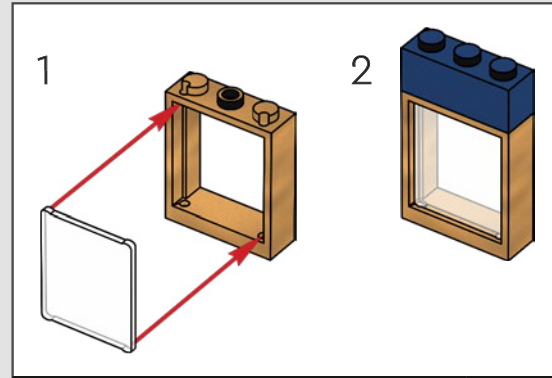

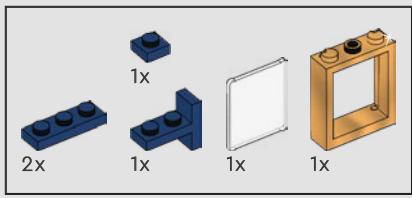

251

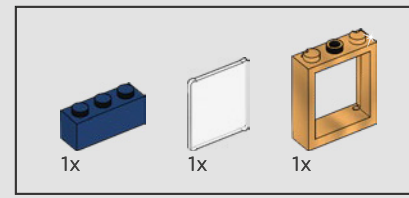
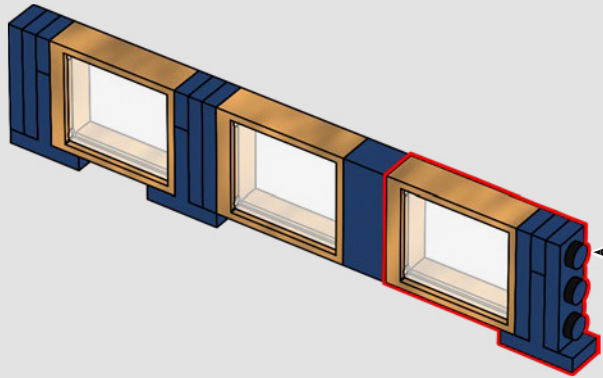
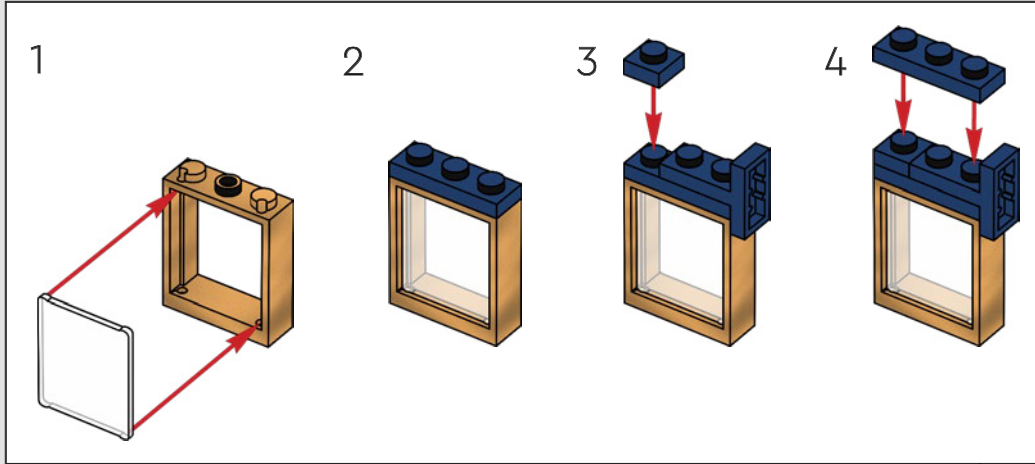

252

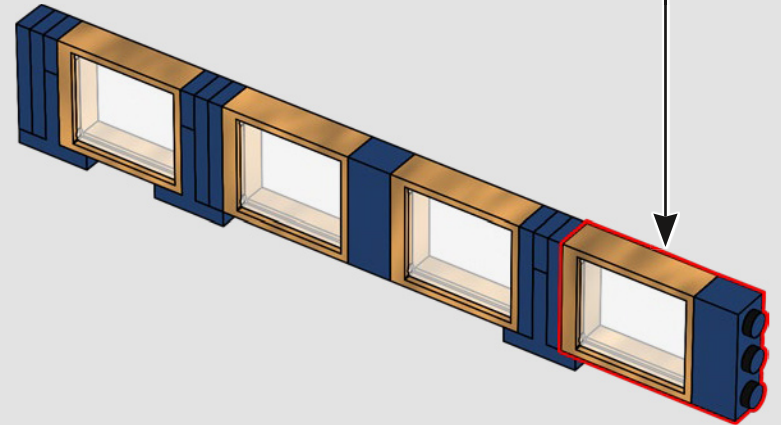
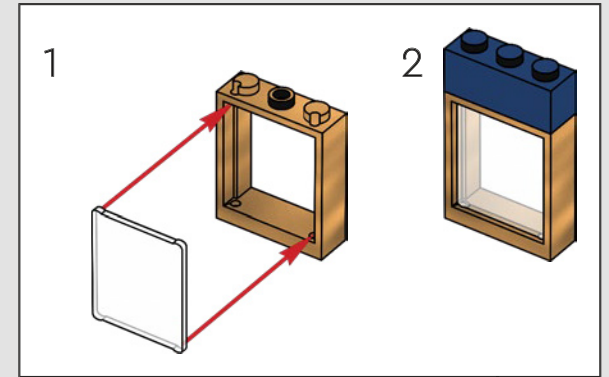

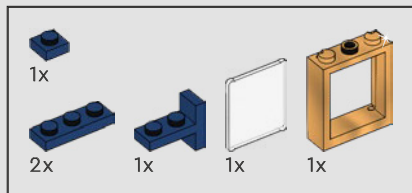

253

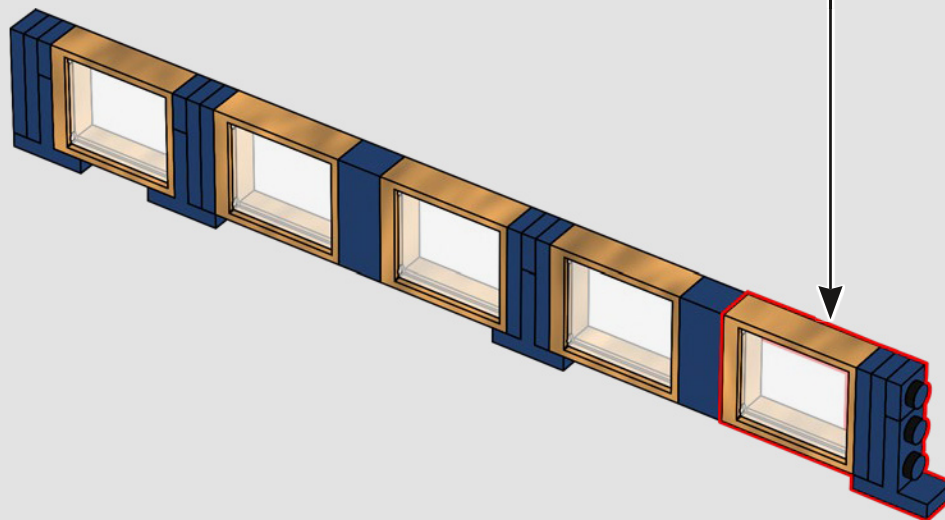
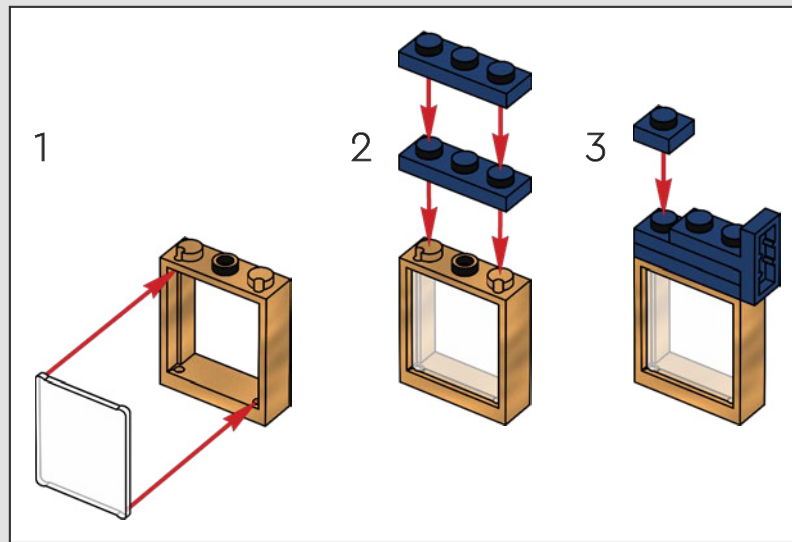

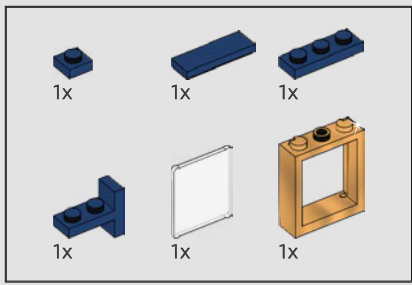

254

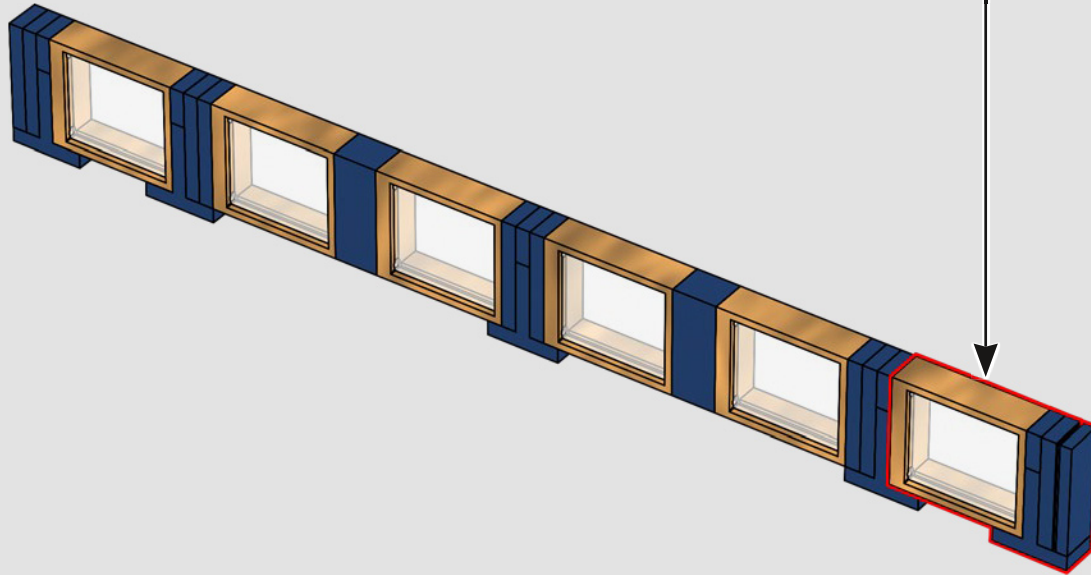
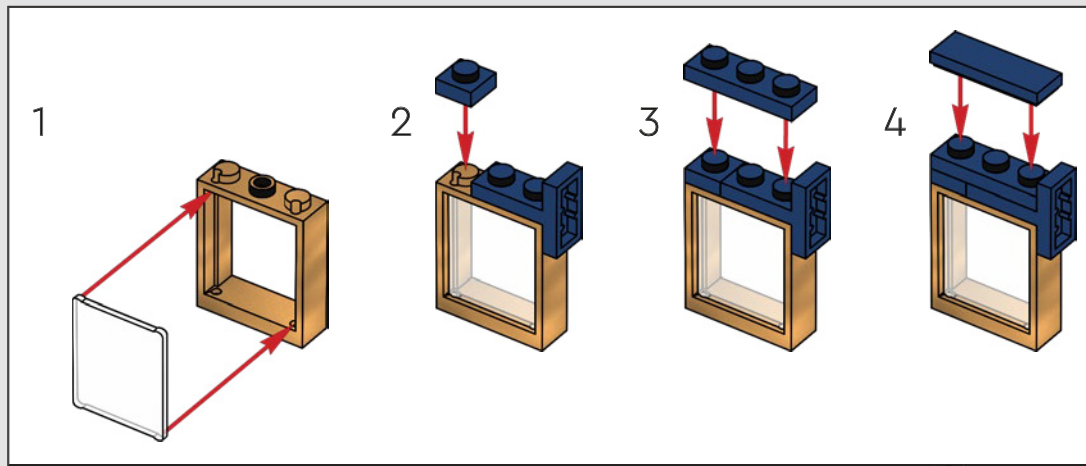

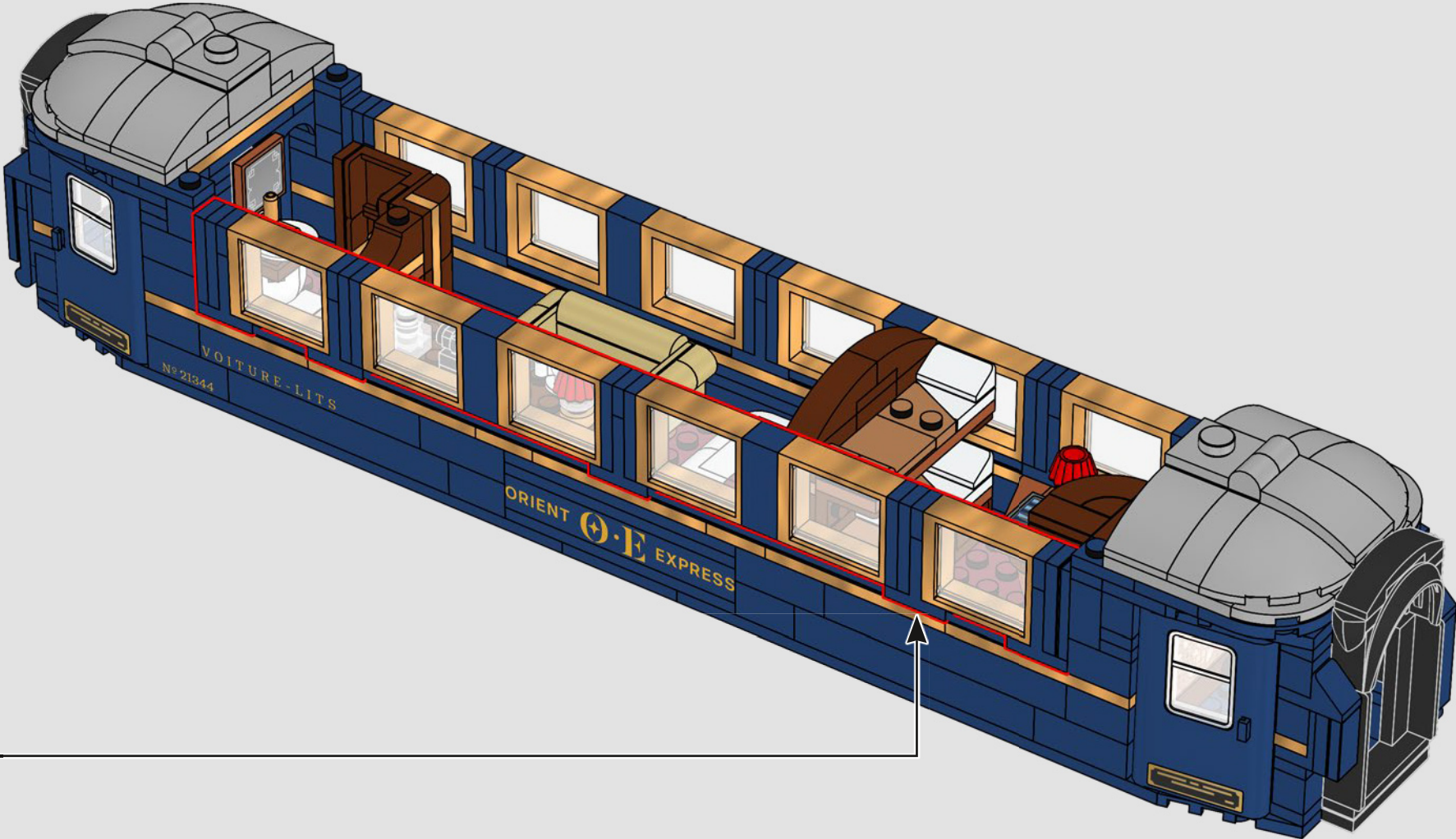

●
“乘客携带着各种行李, 从手工艺品到个人物品.....有些人带着很多行李!”

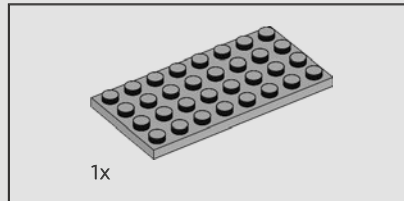
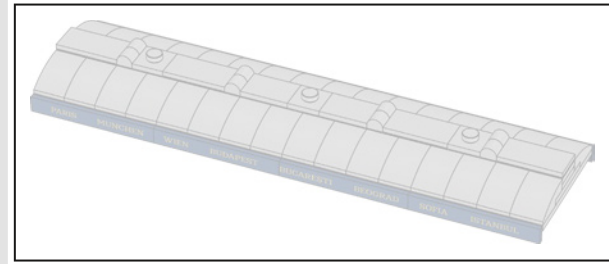
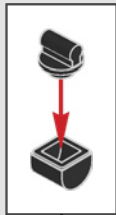
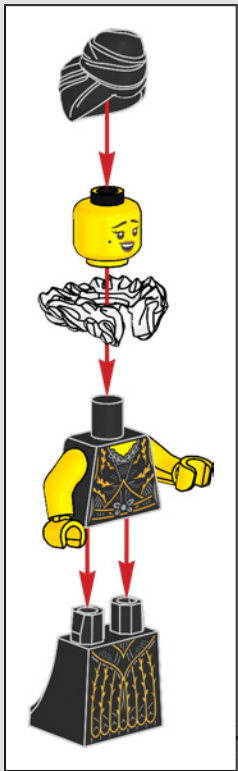

256

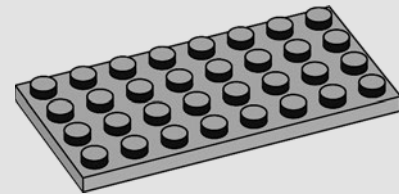

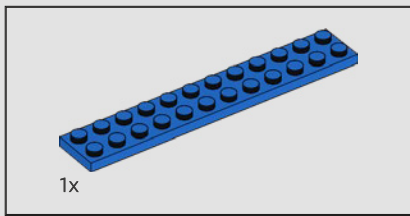

257

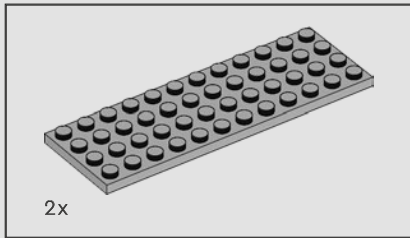
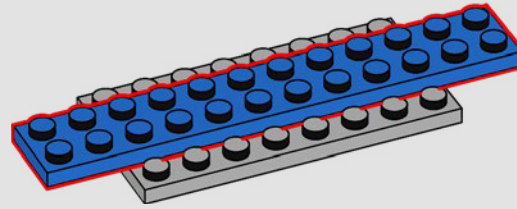

258

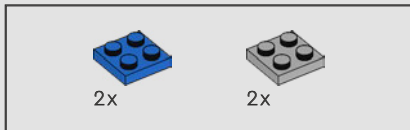
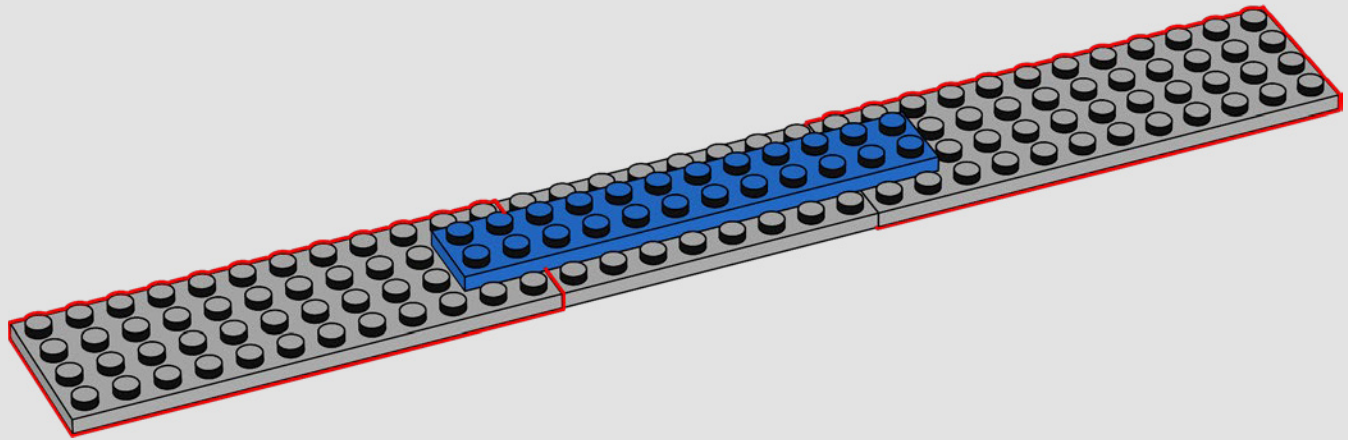

259

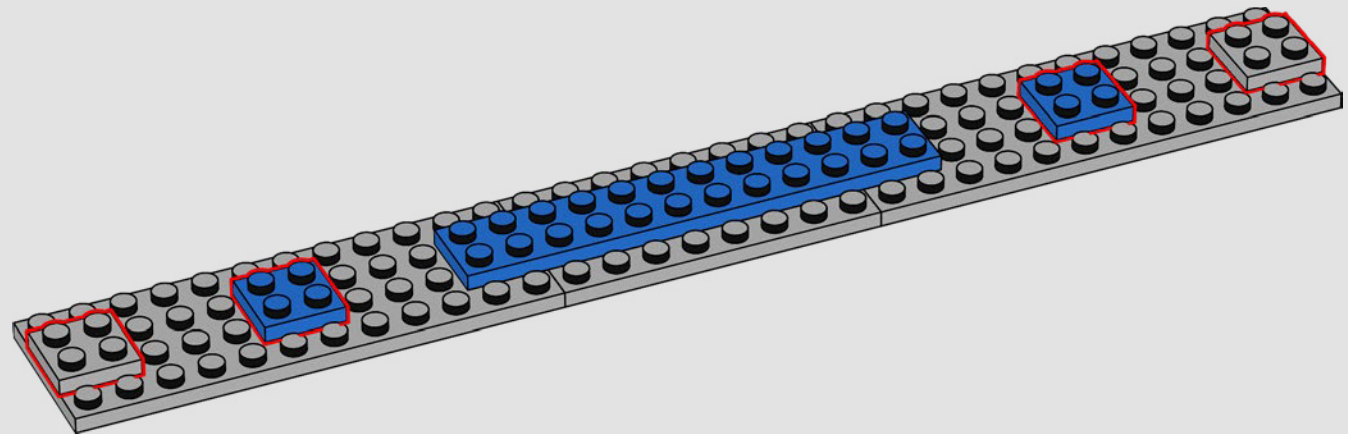

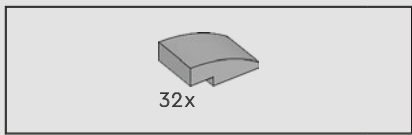

260

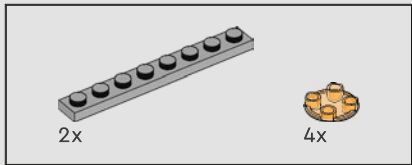
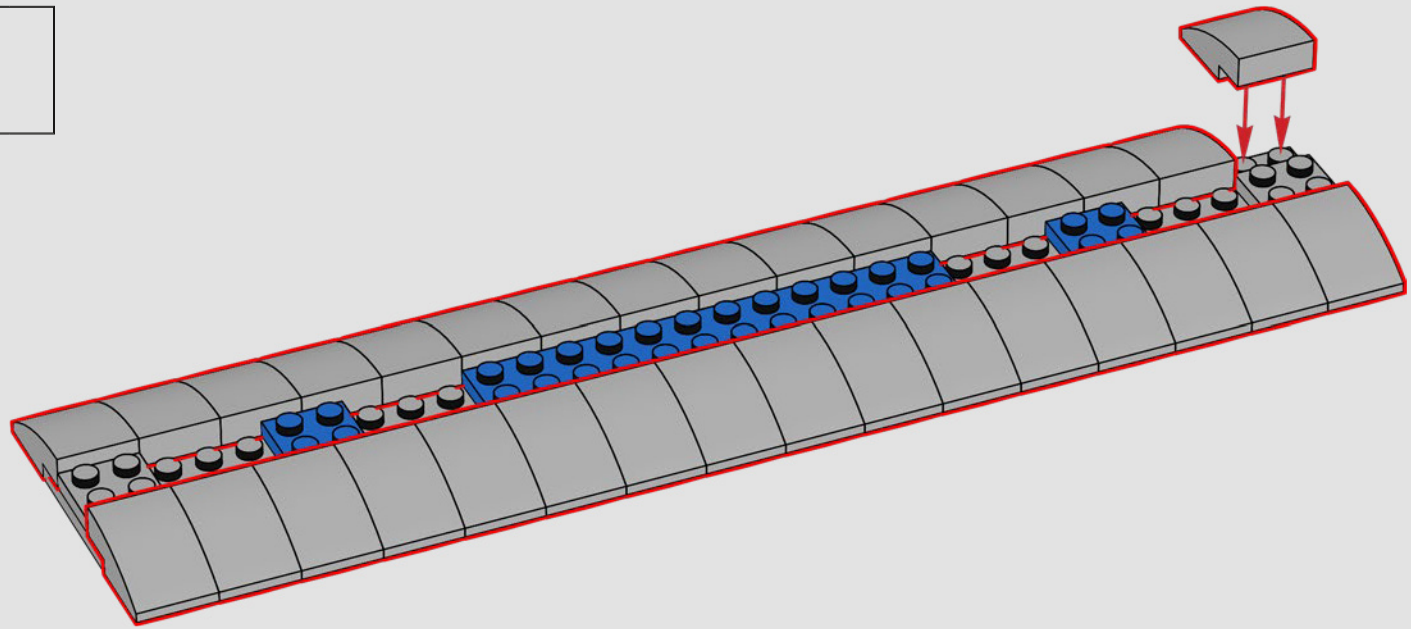

261

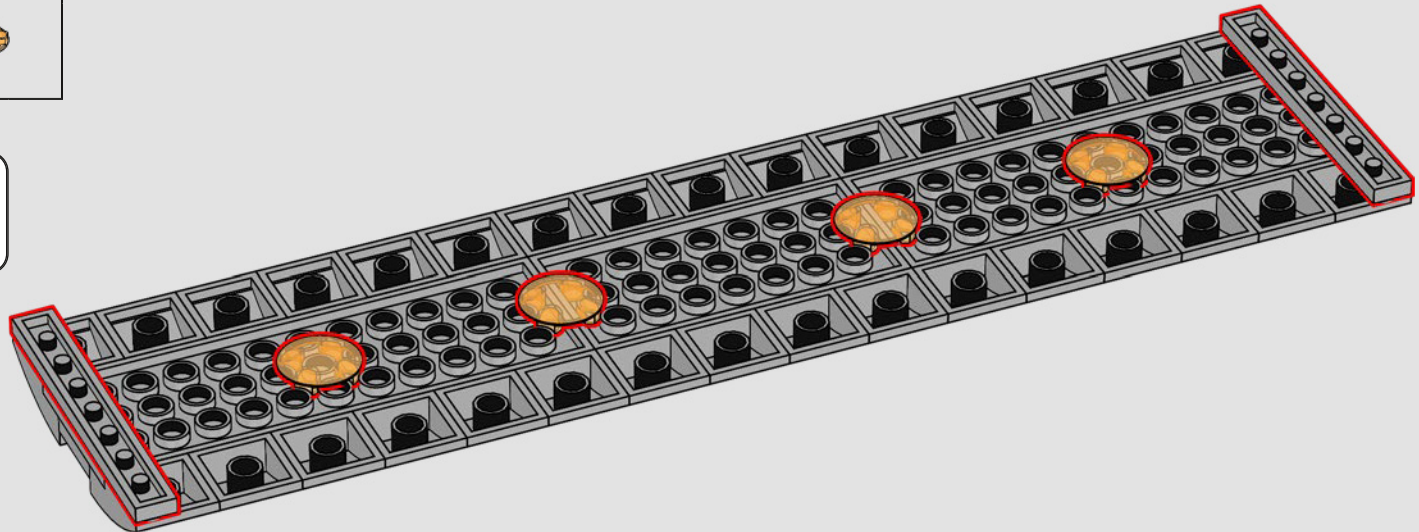

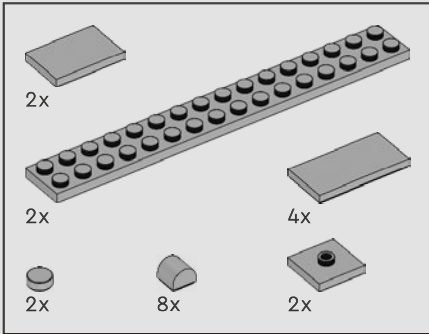
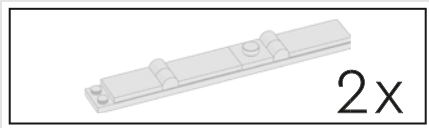

262

1

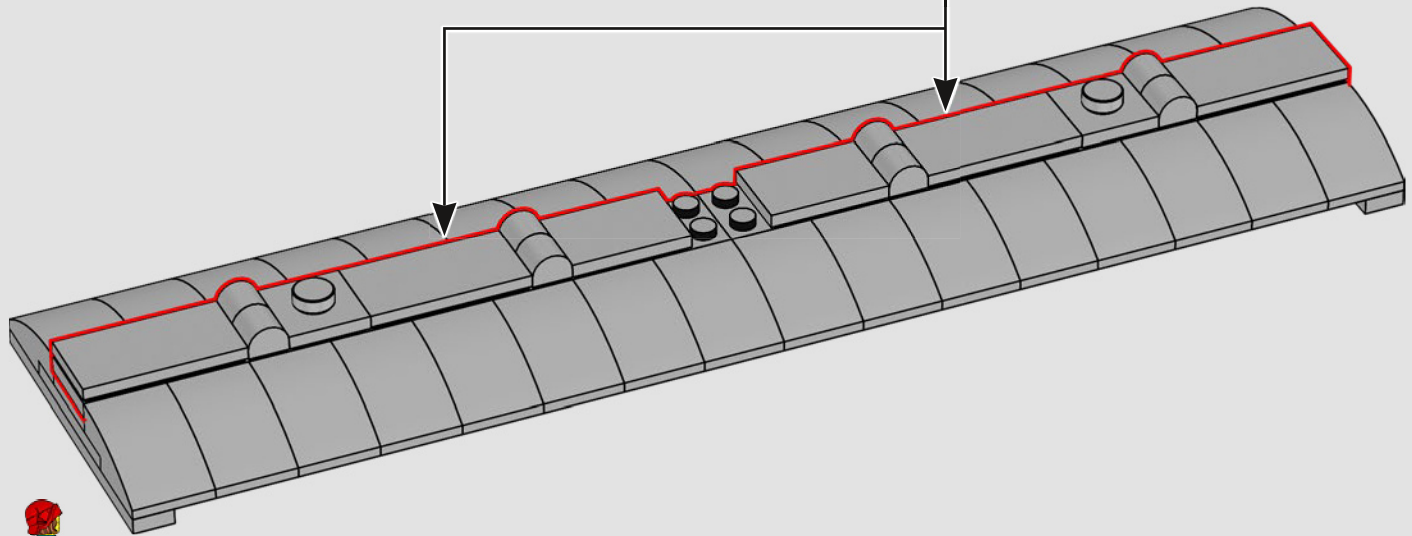
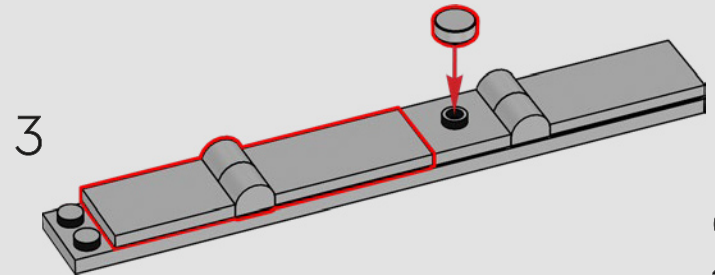
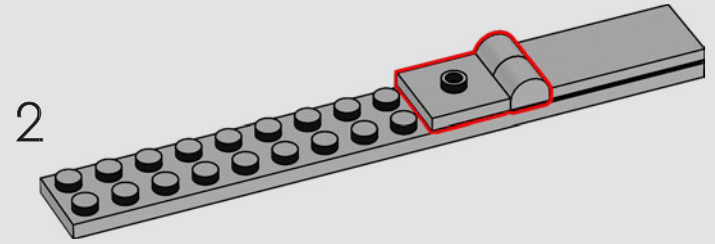
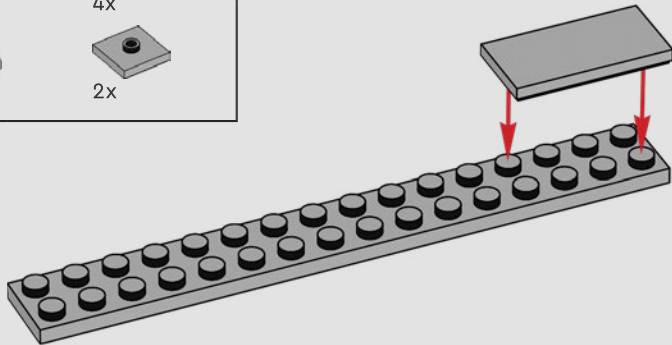

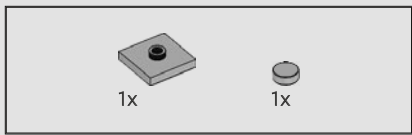

263

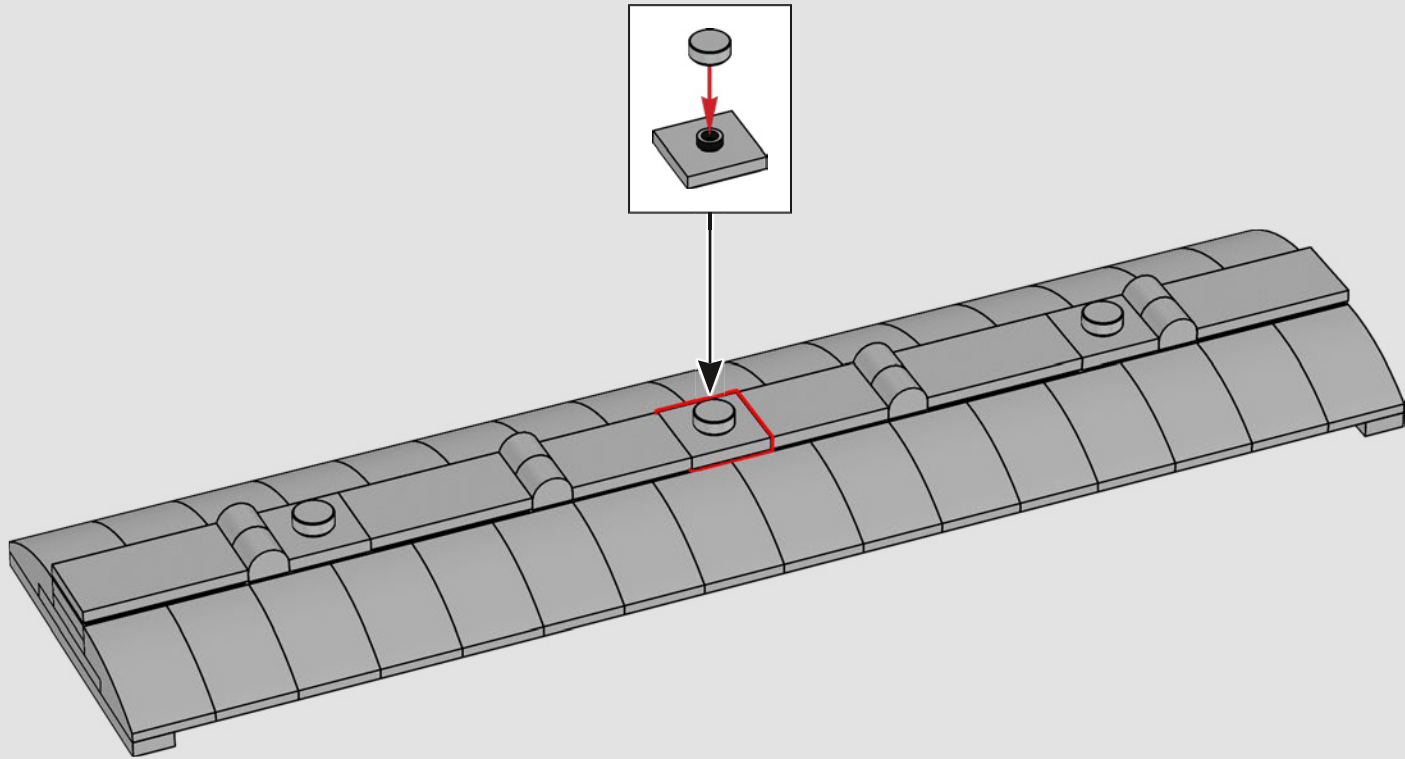

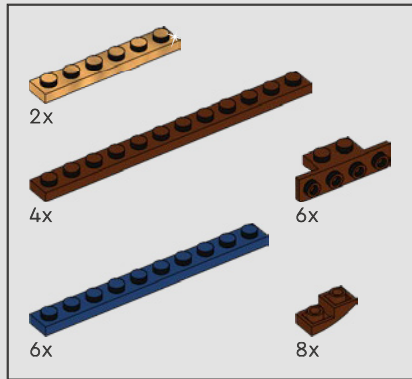
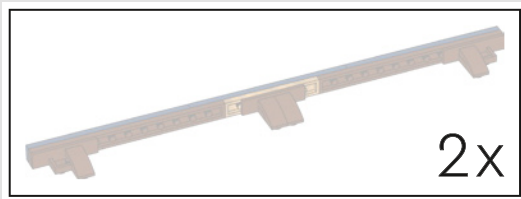

264

1

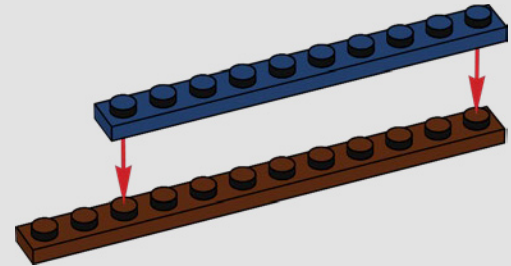

2

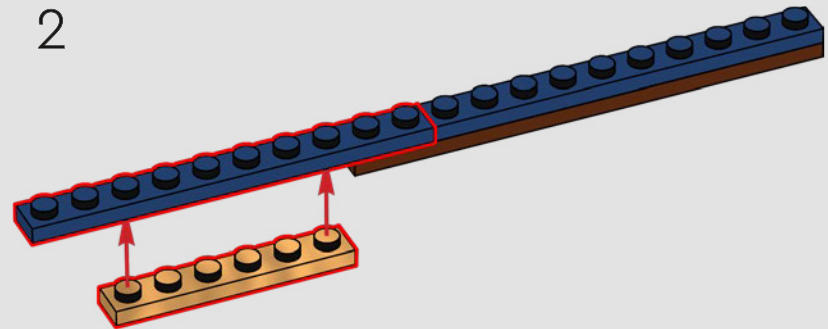

3

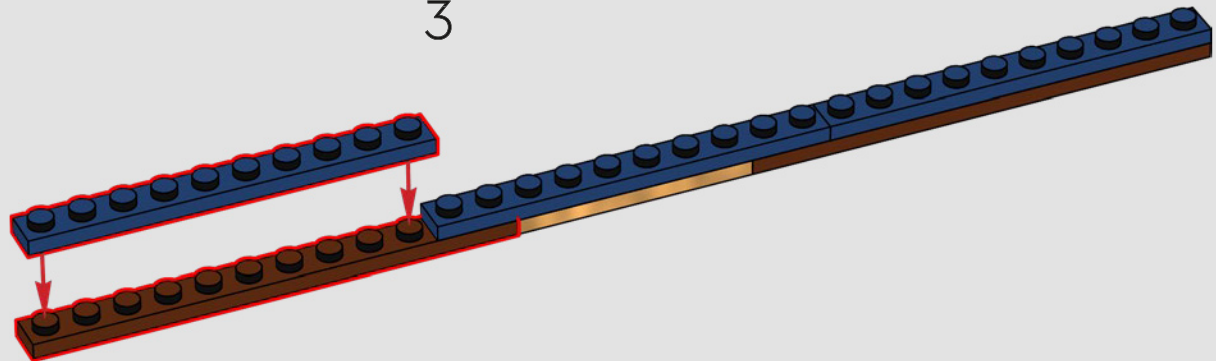

4

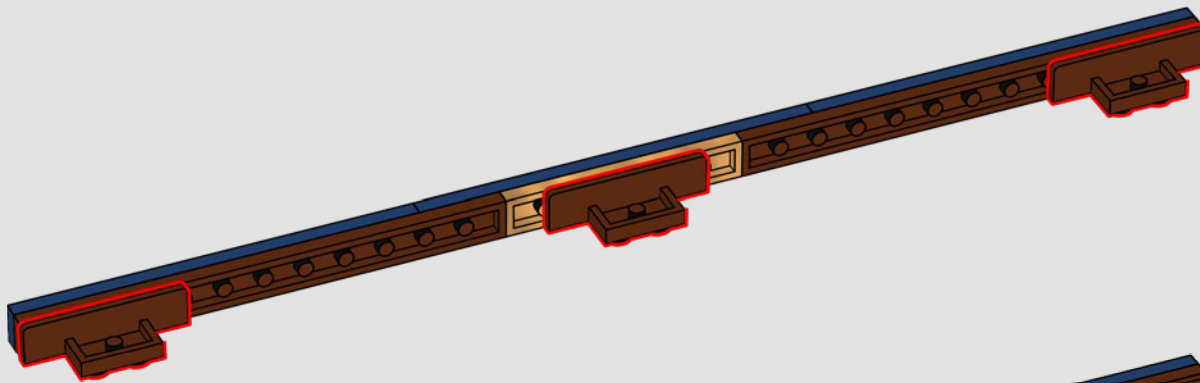

5

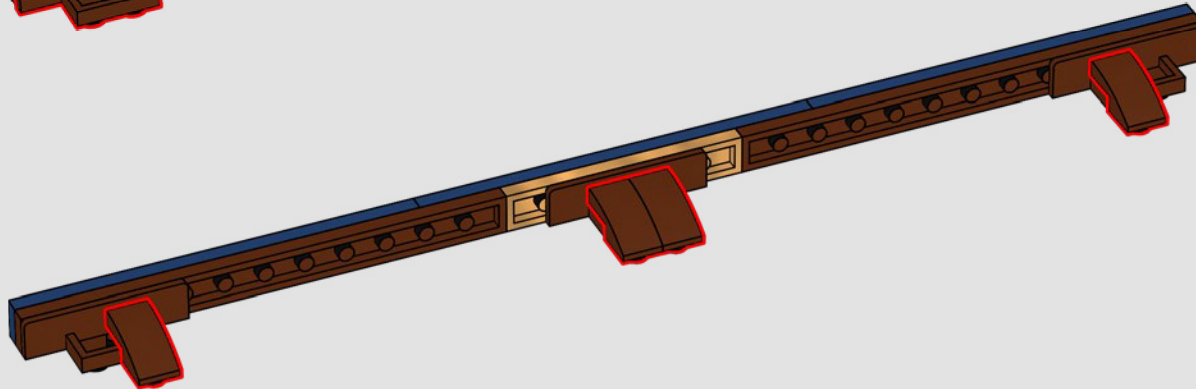

2x

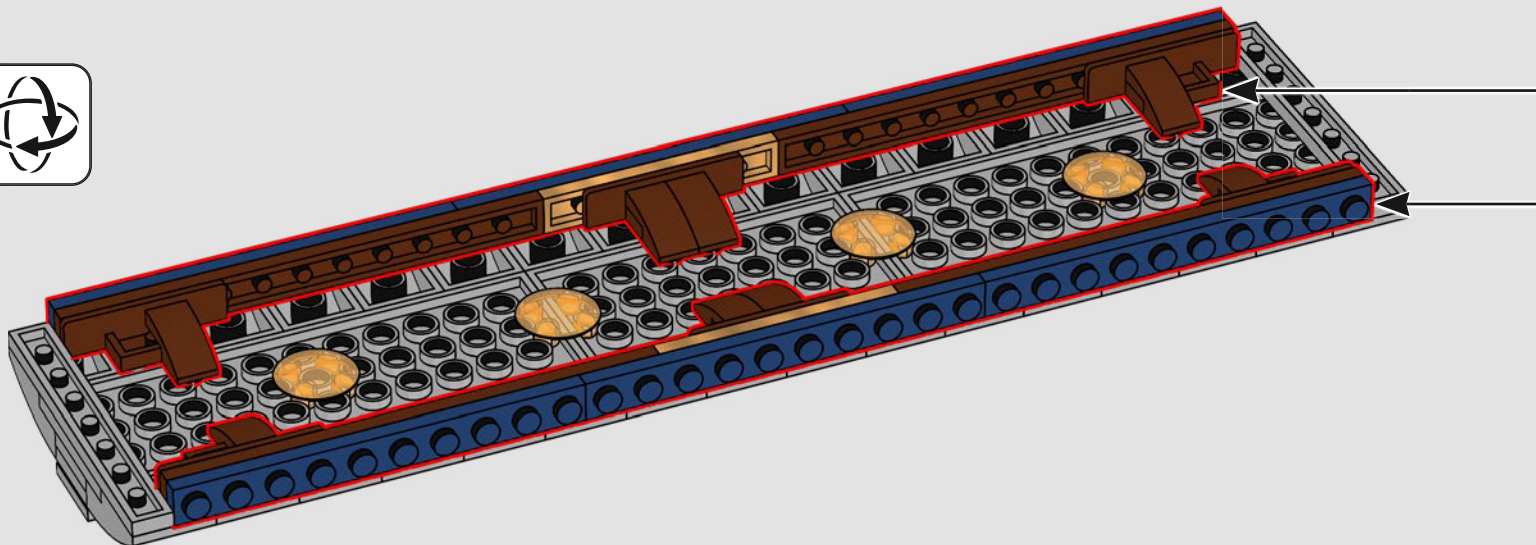

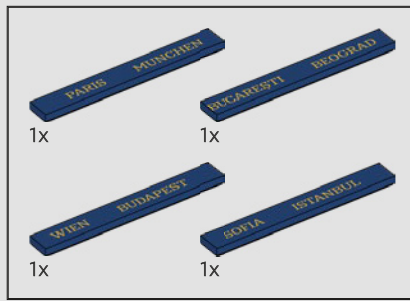

265

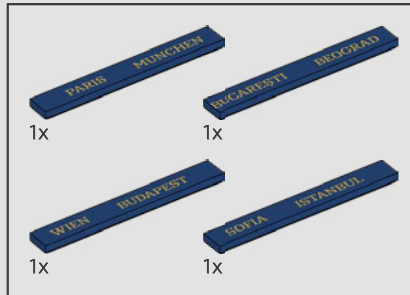
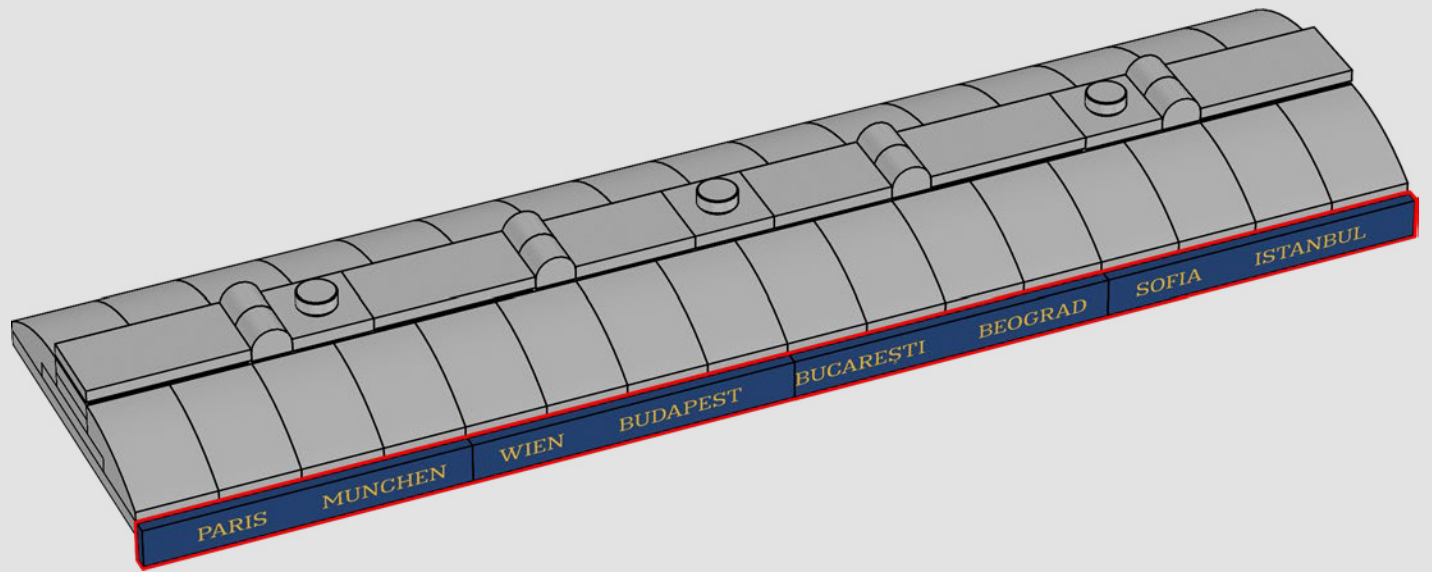
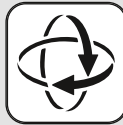

266

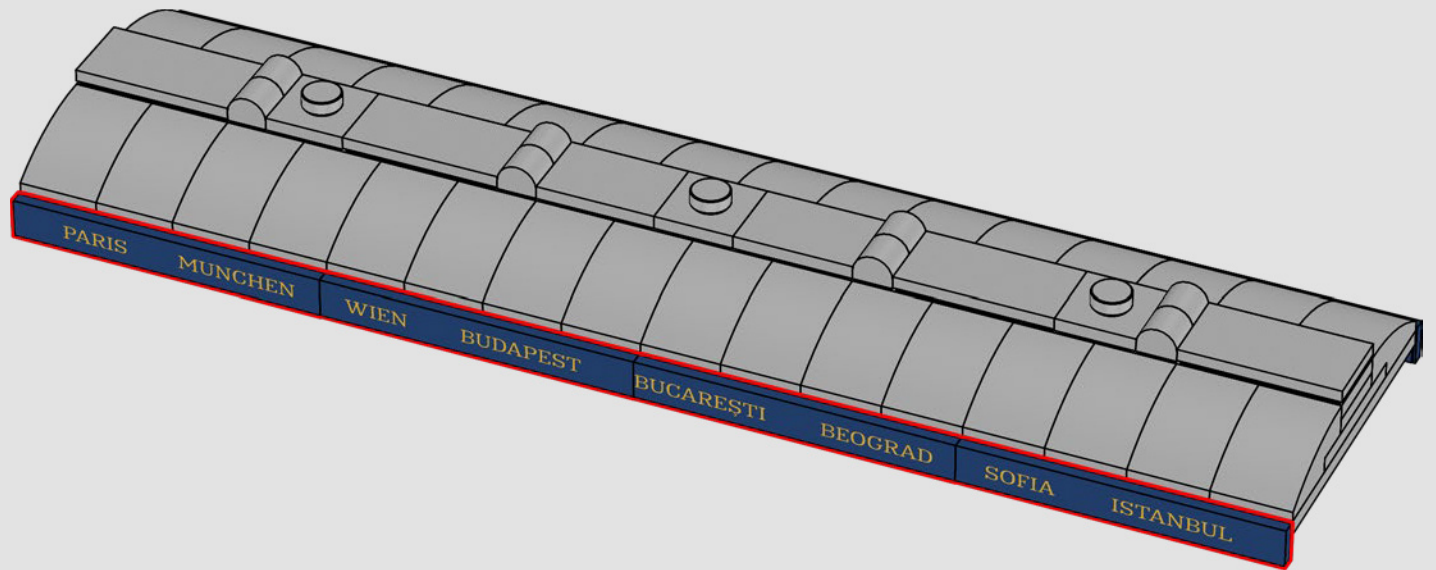

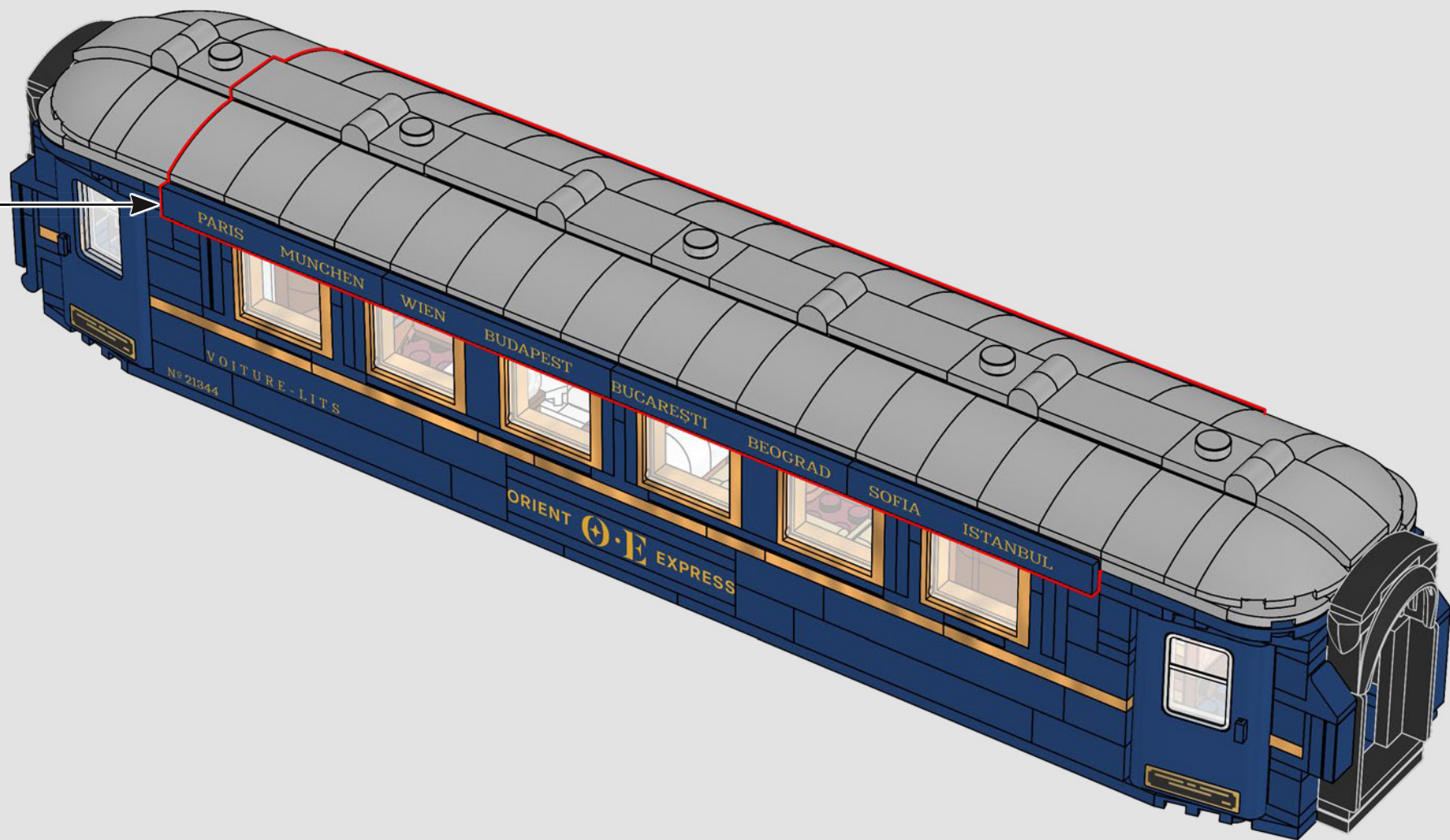

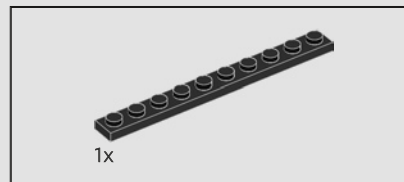
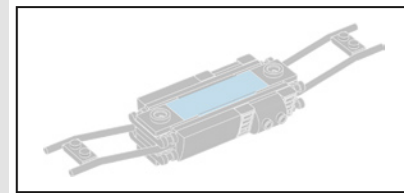
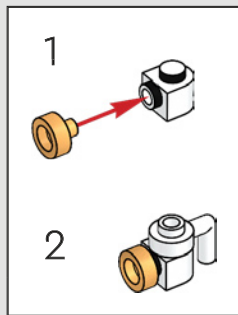
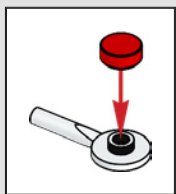
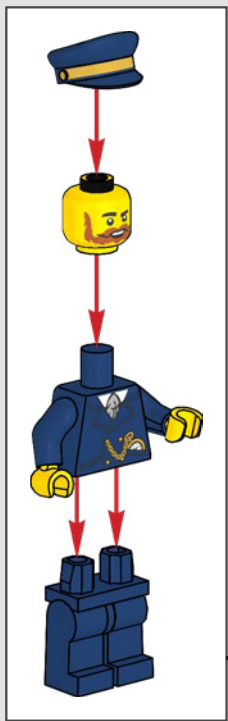

268

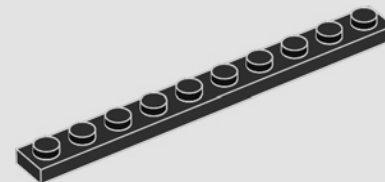

下一站: 贝尔格莱德

“火车站经理负责检查每节车厢与火车的连接。”

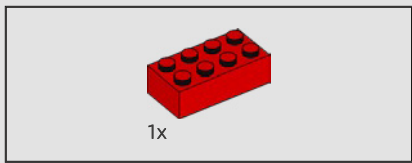

269

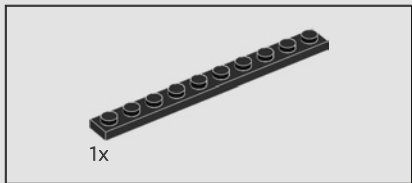
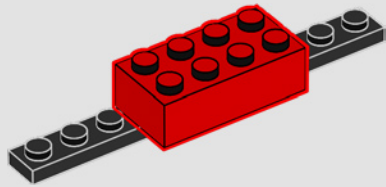

270

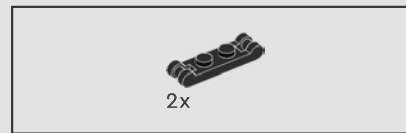
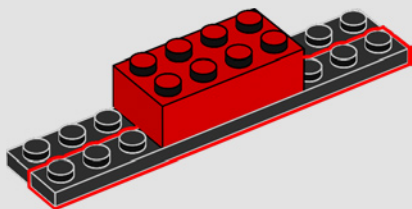

271

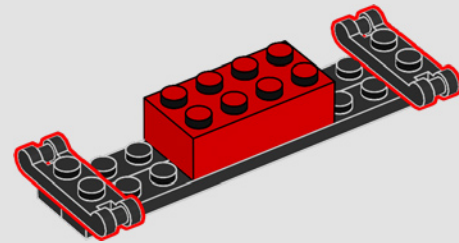

272

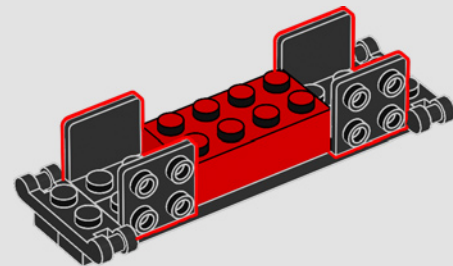

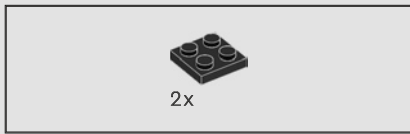

273

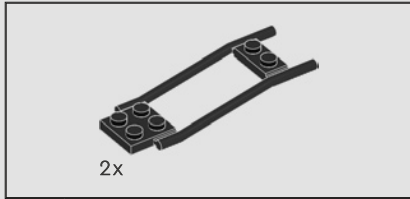
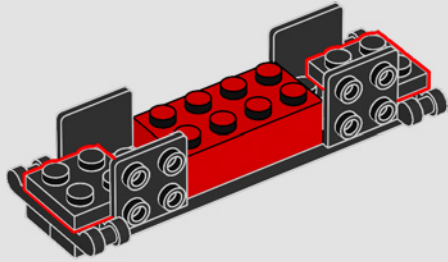

274

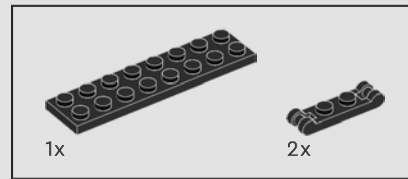
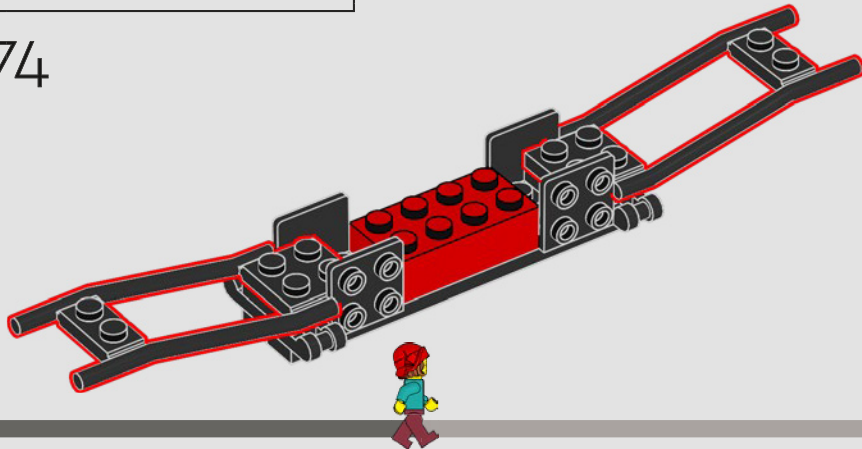

275

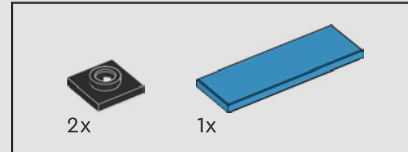
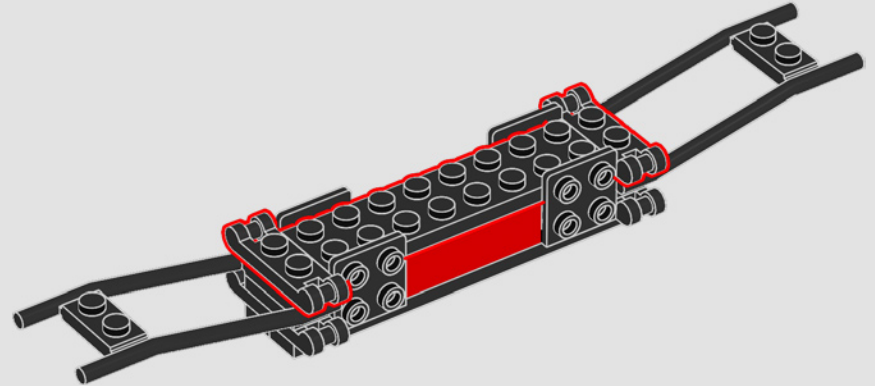

276

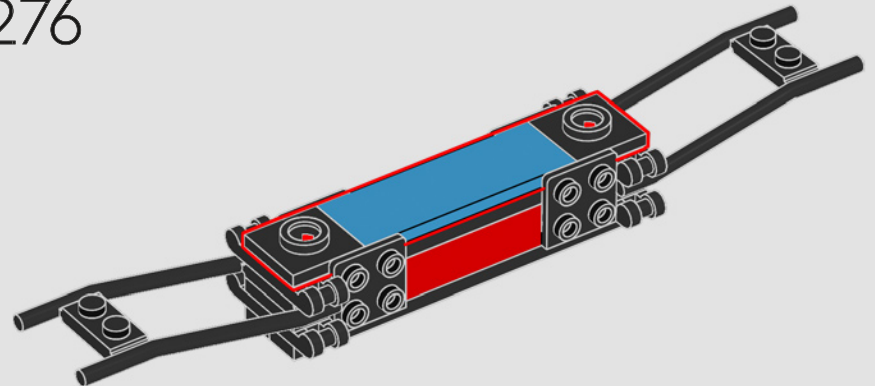

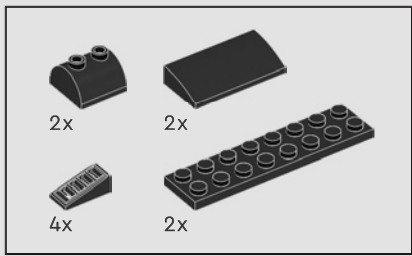

277

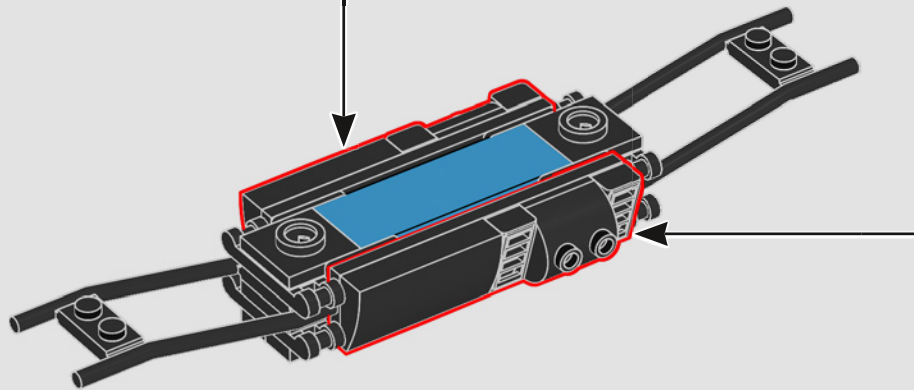
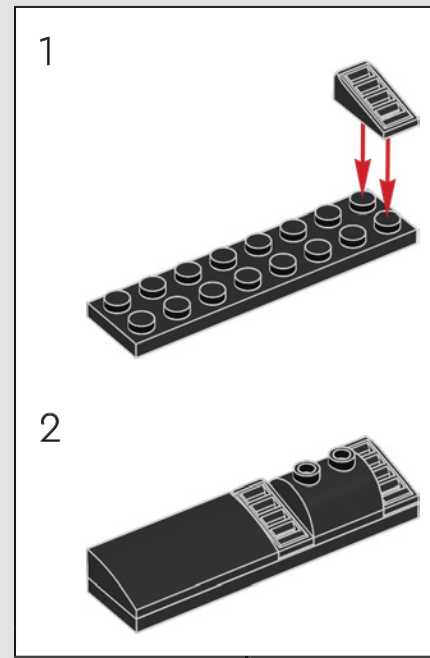
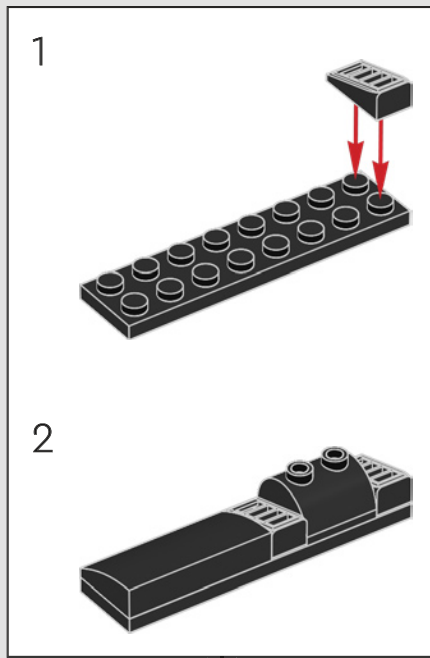

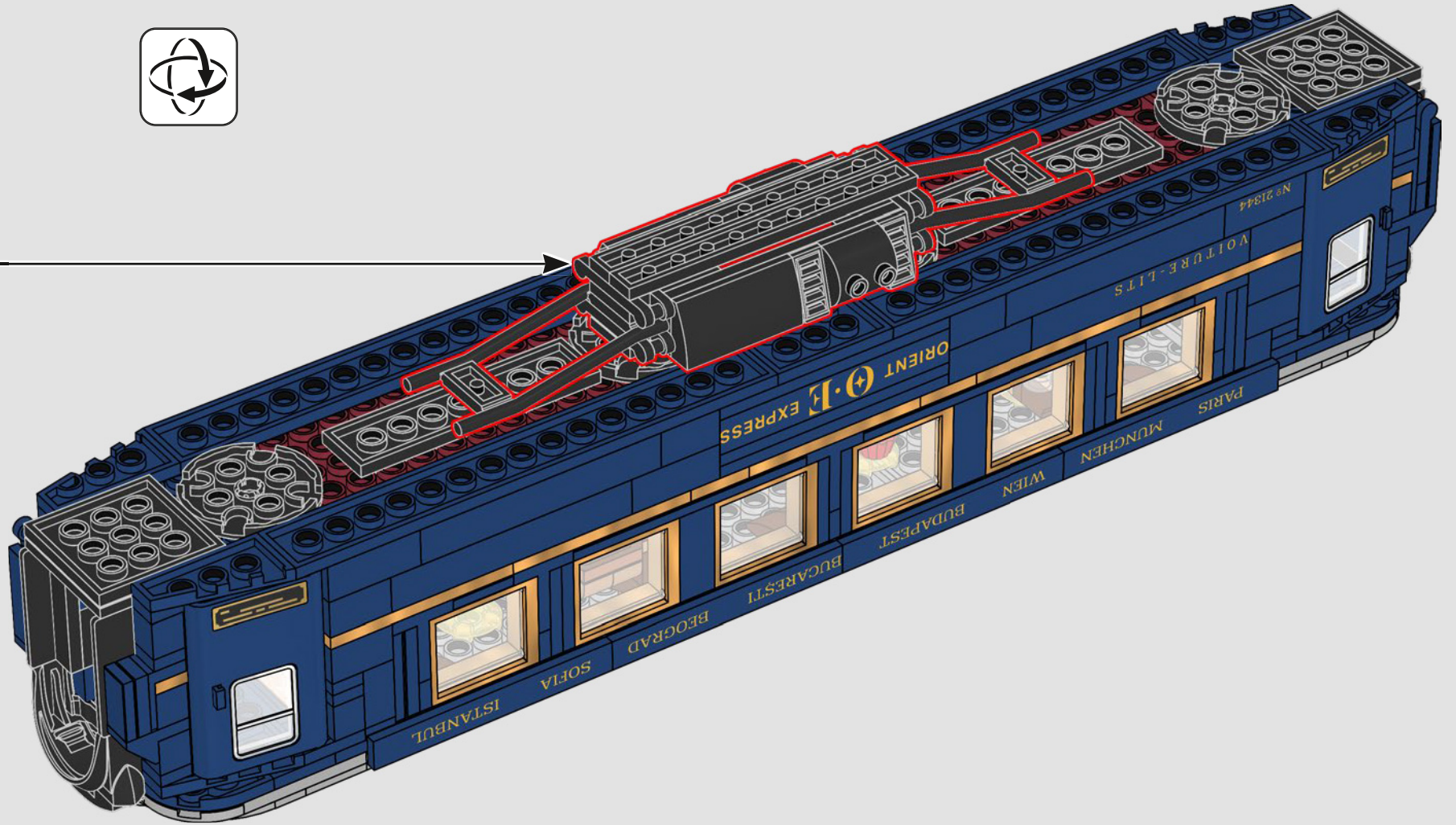

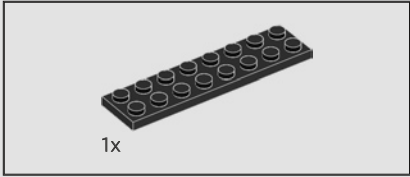
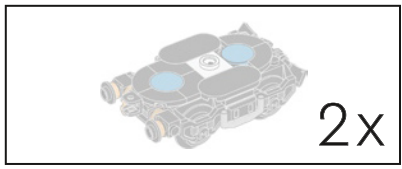

279

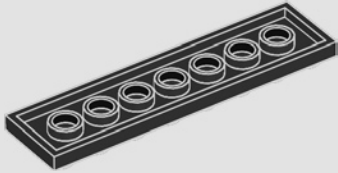

280

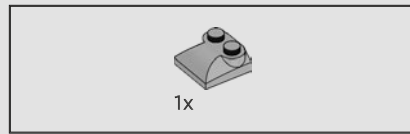
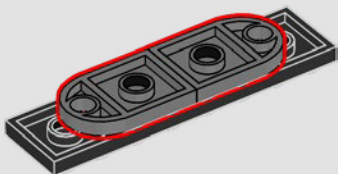

281

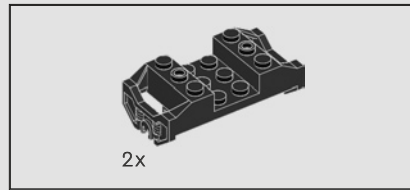
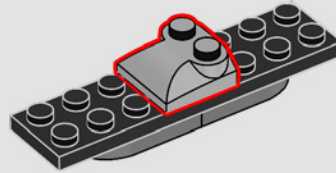

282

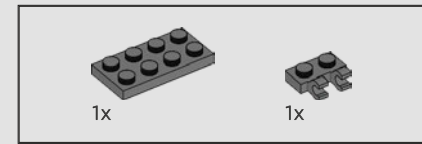
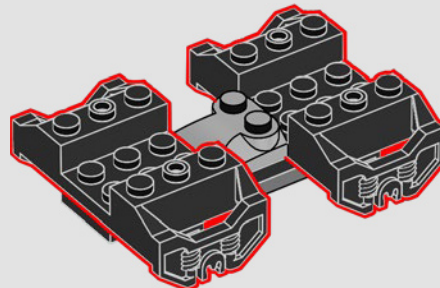

283

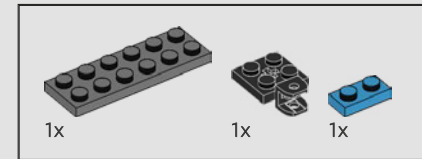
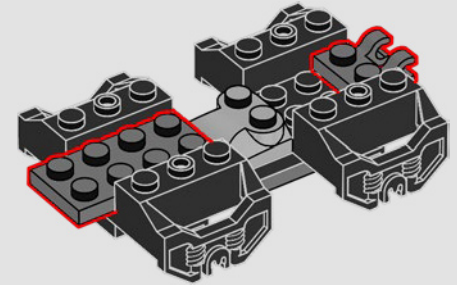

284

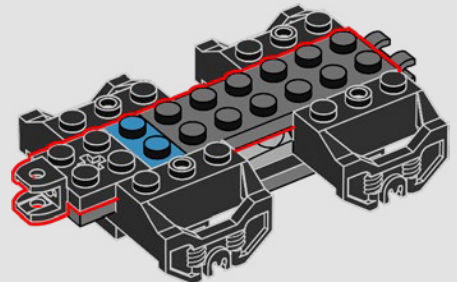

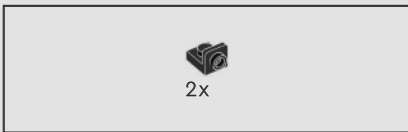

285

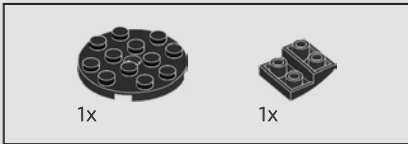
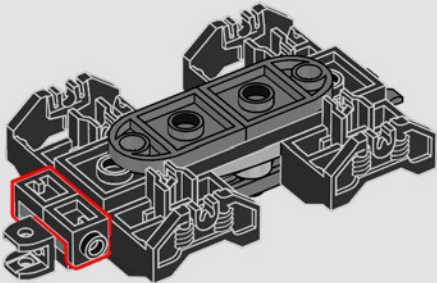

286

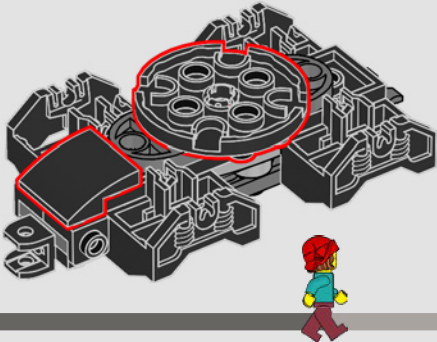

287

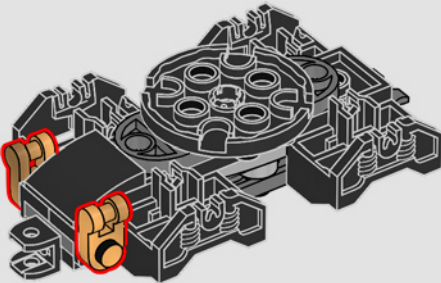

288

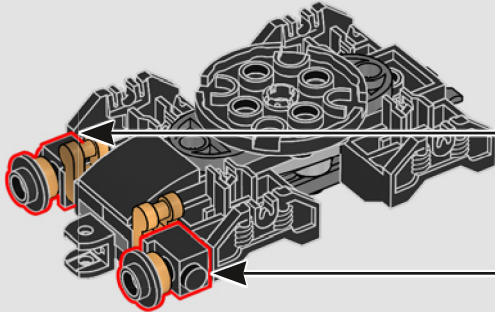
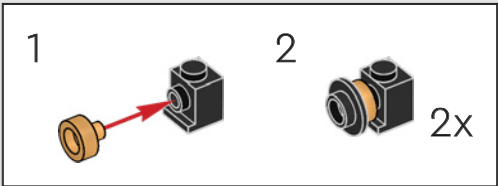

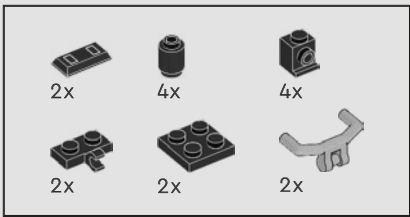

289

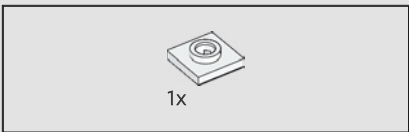
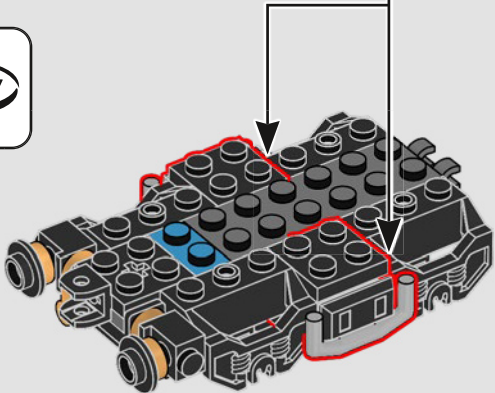
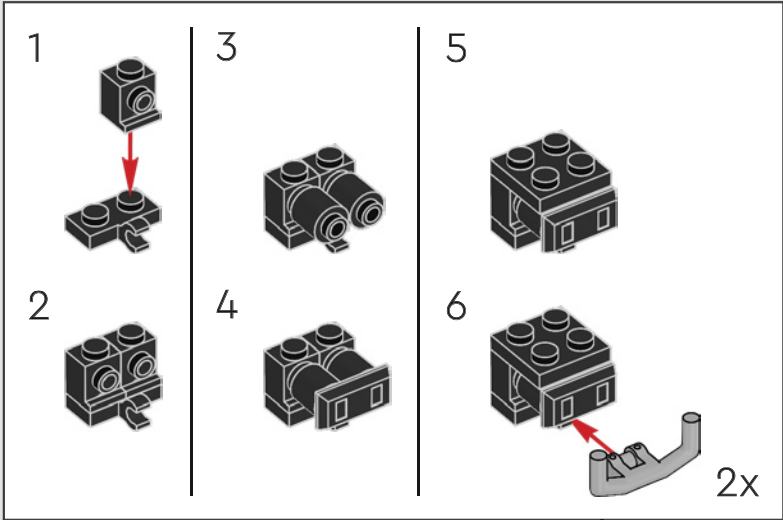

290

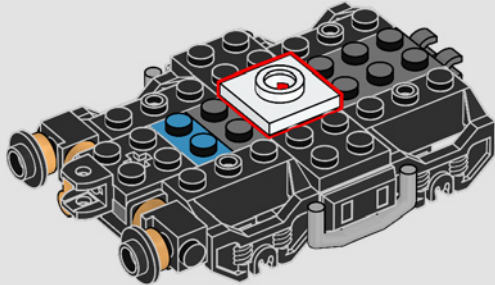

291

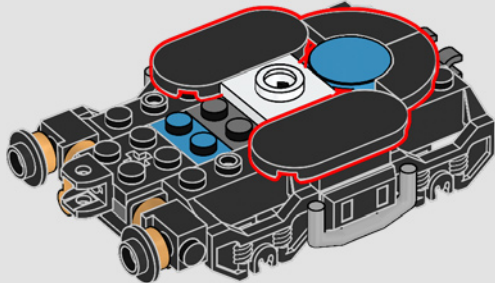

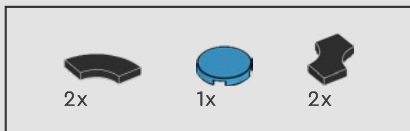

292

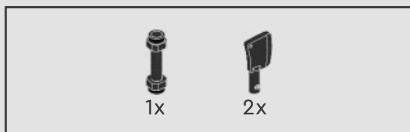
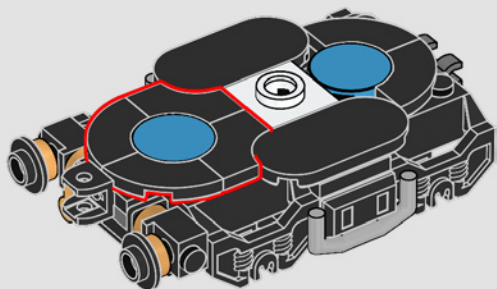

293

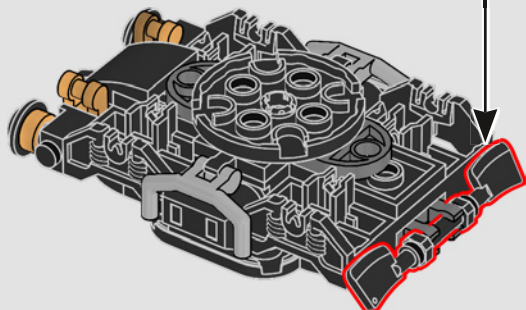
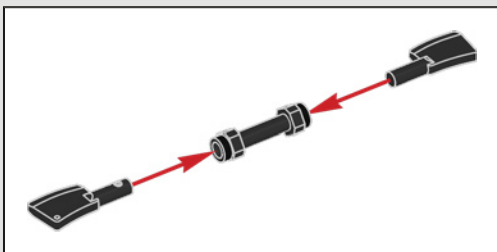

294

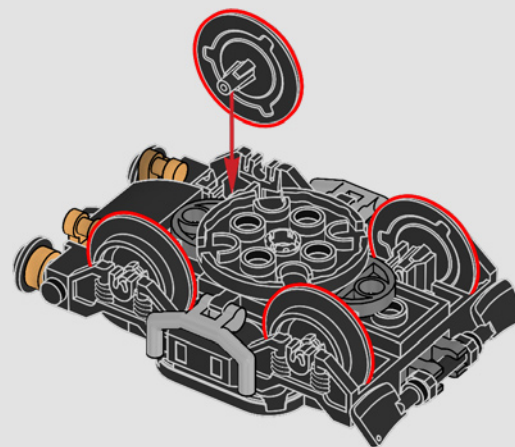

2x

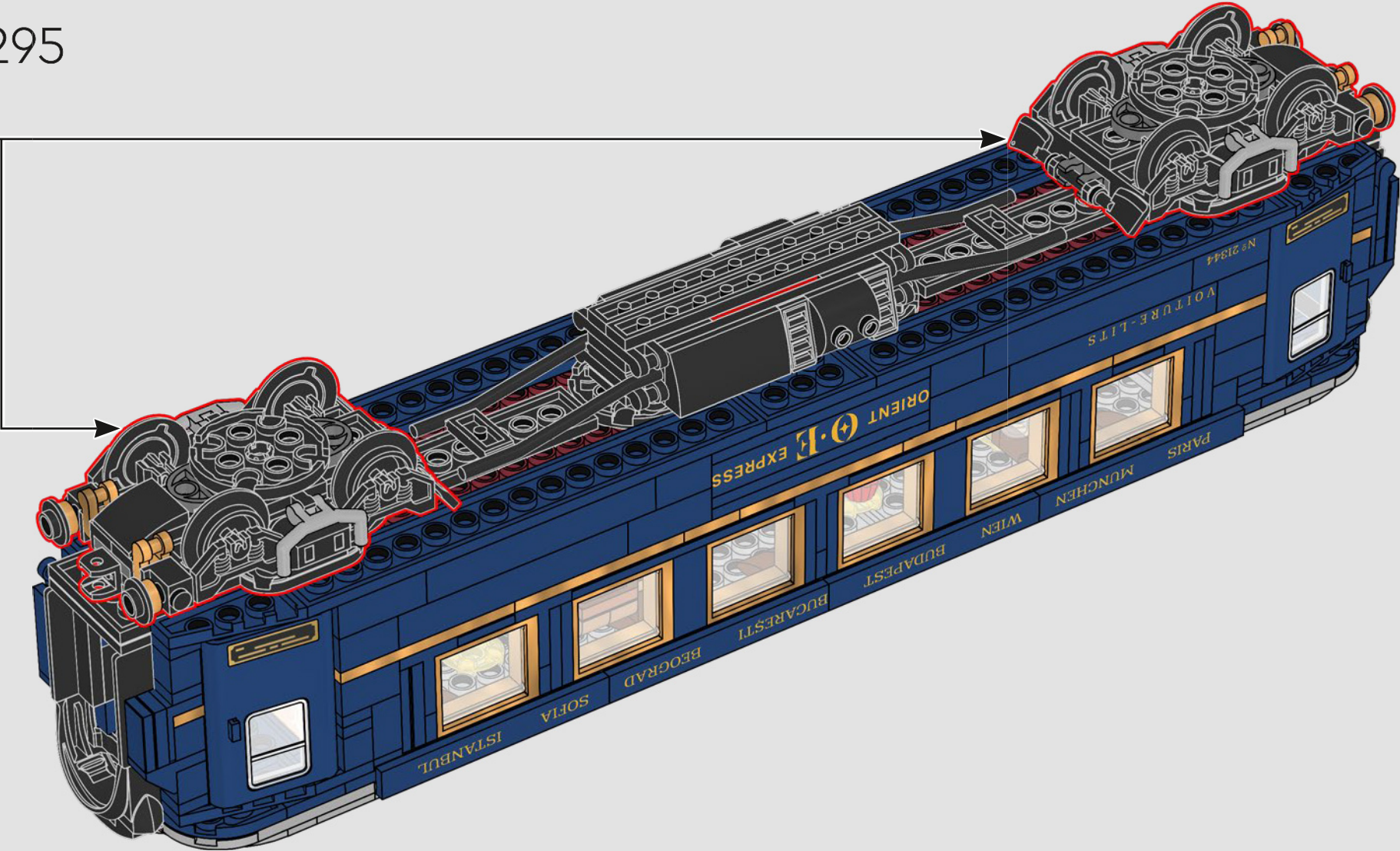



296

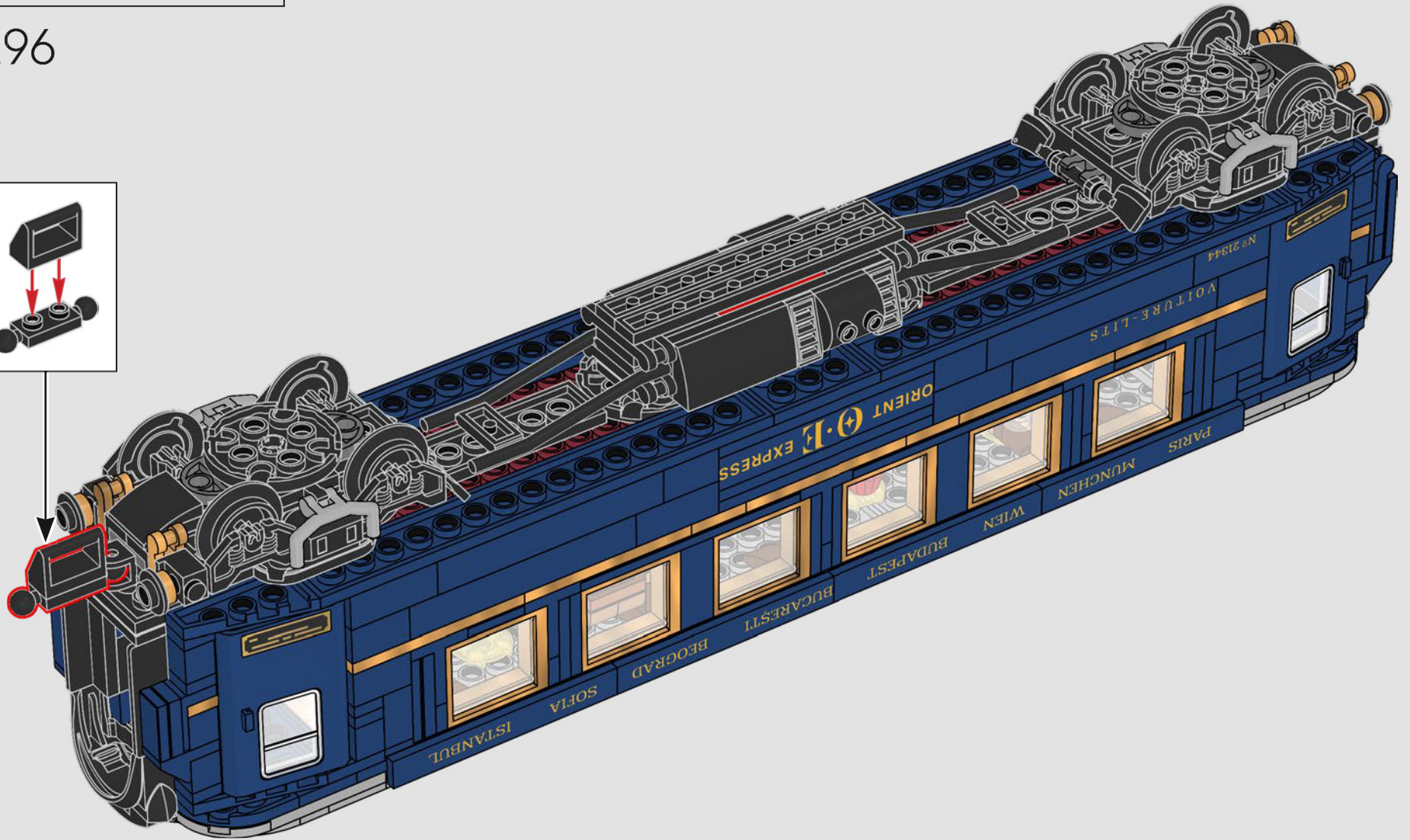
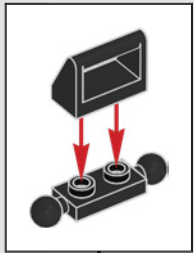

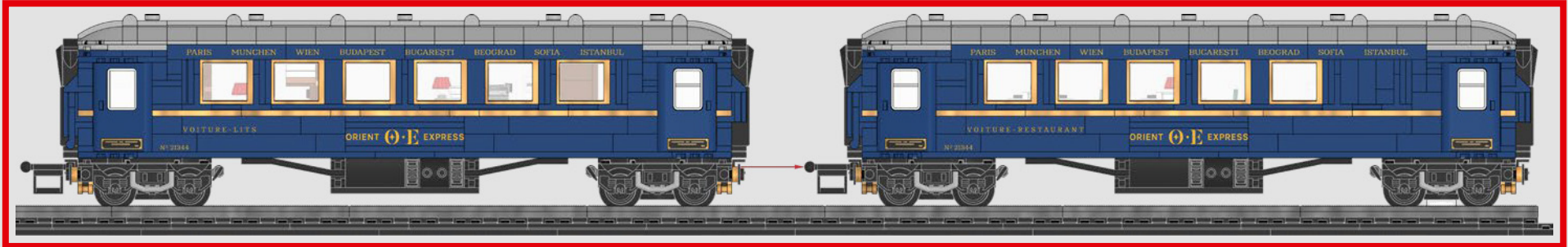
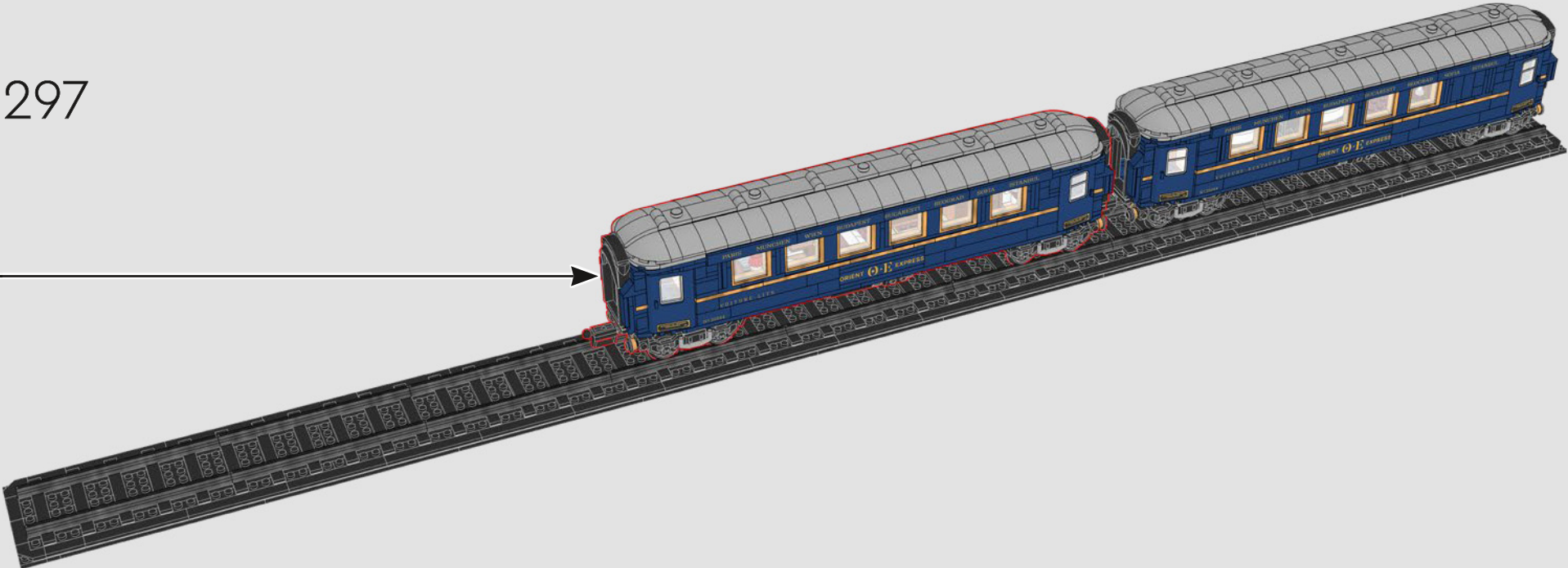

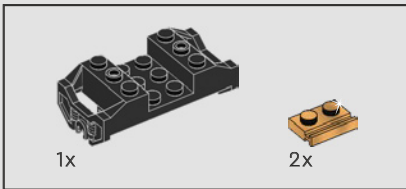
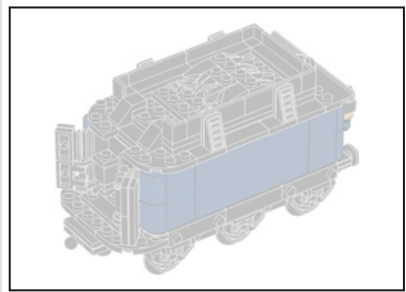

298

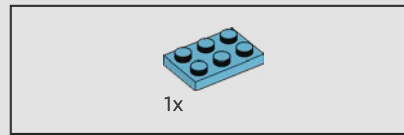
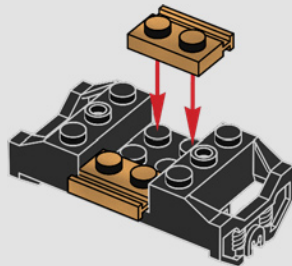

299

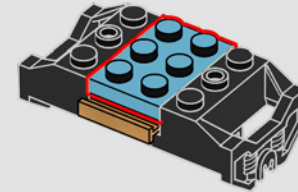

300

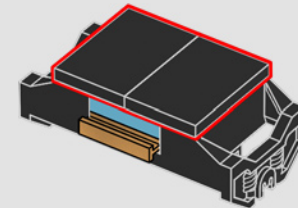

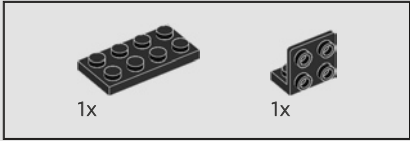
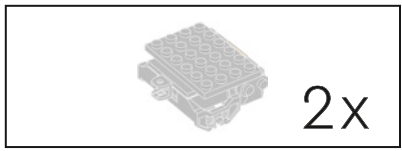

301

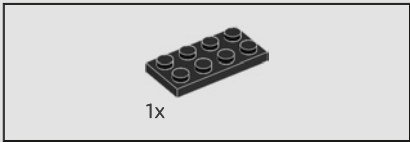
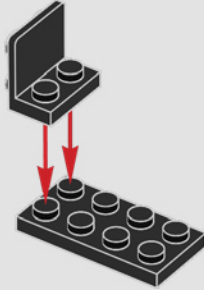

302

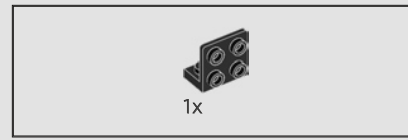
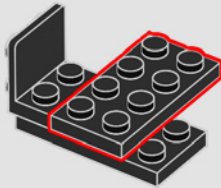

303

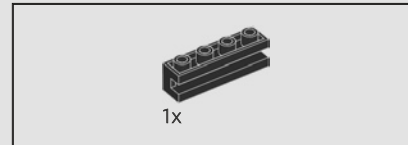
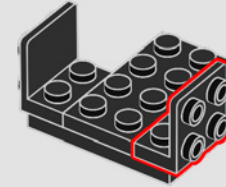

304

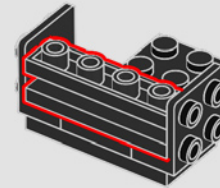



305

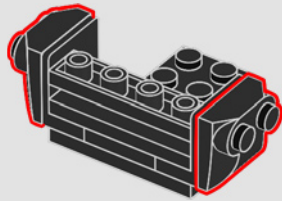

306

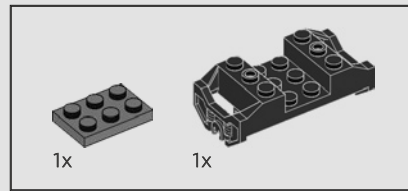
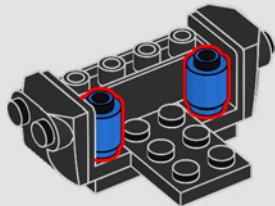

307

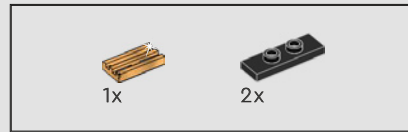
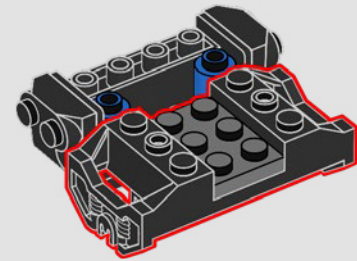
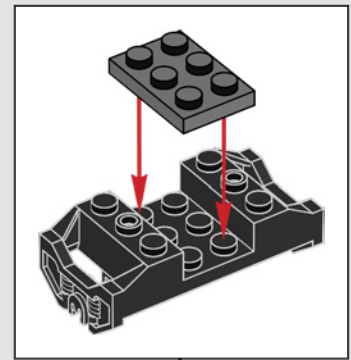

308

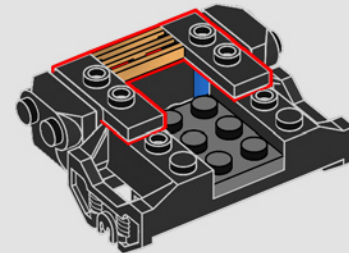

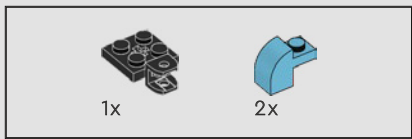

309

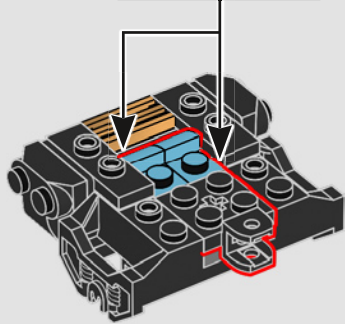
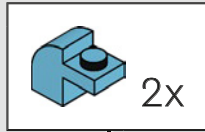

310

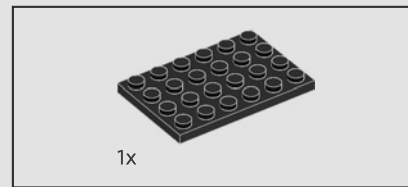
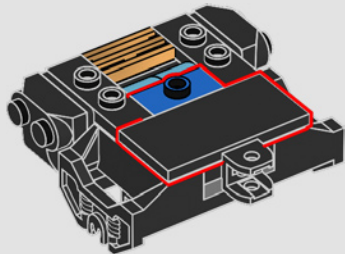

311

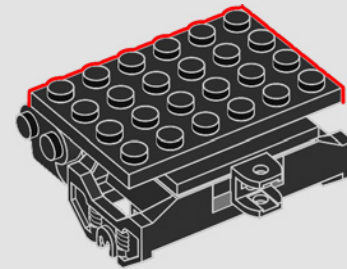

2x

312

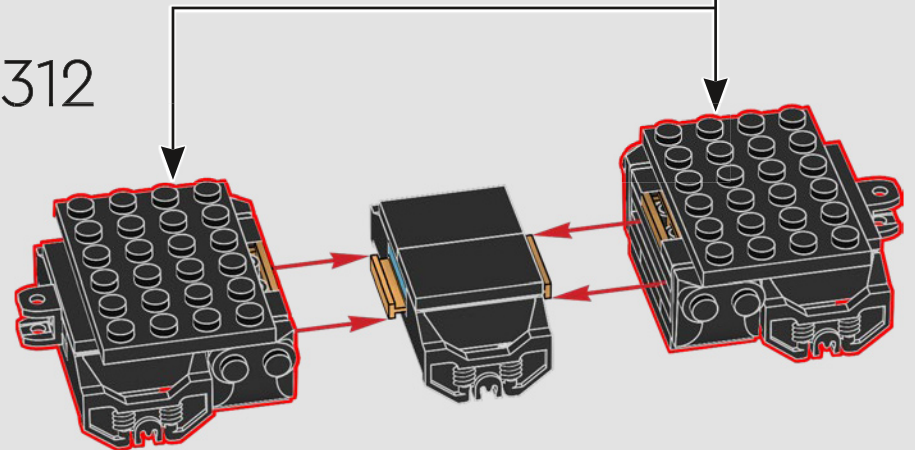

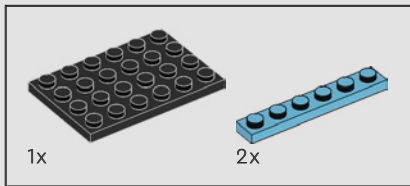

313

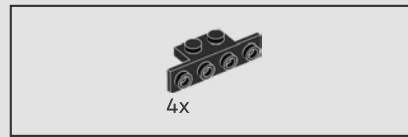
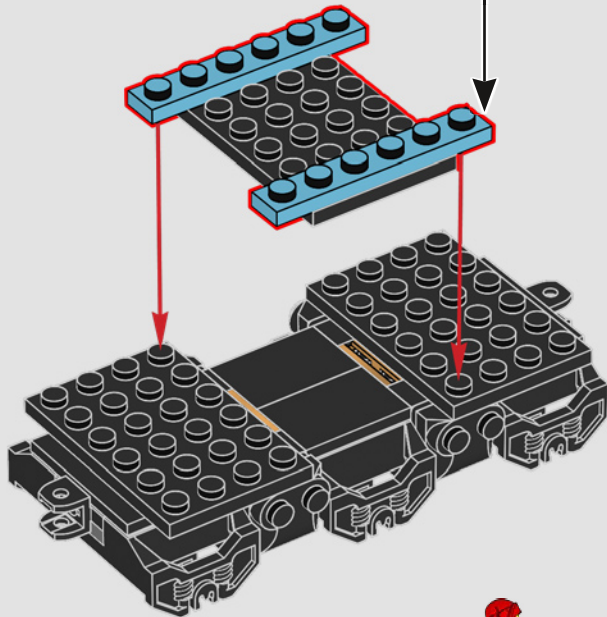
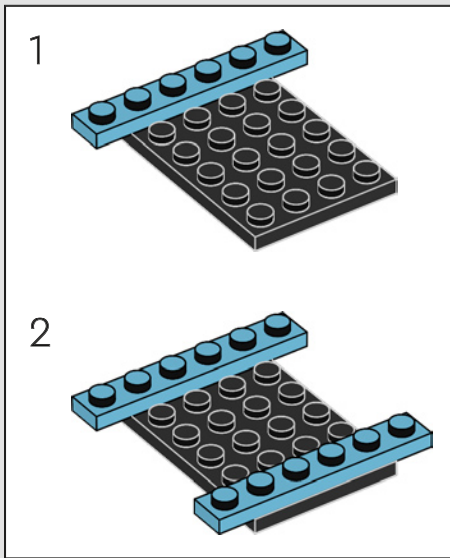

314

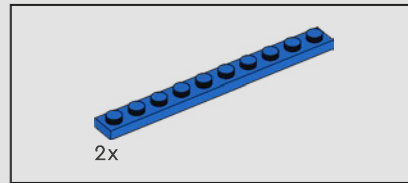
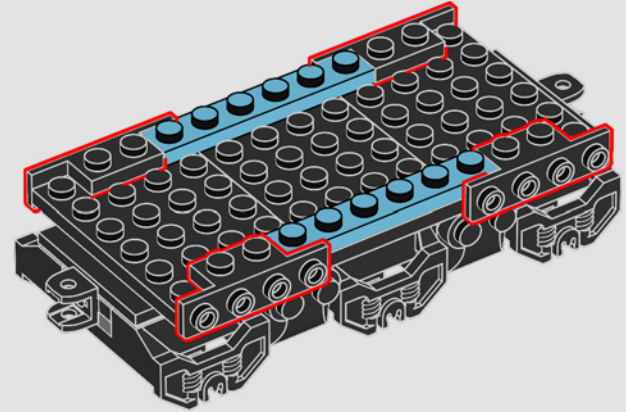

315

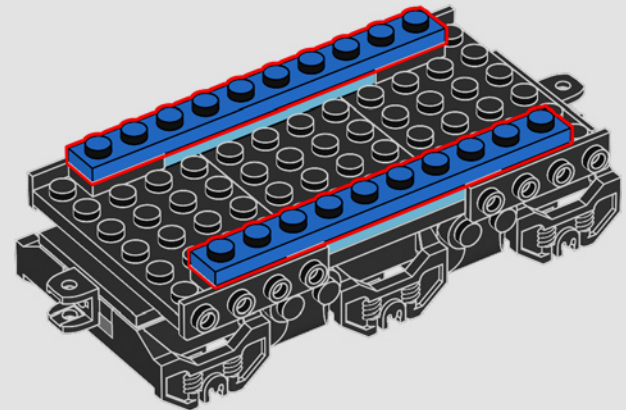

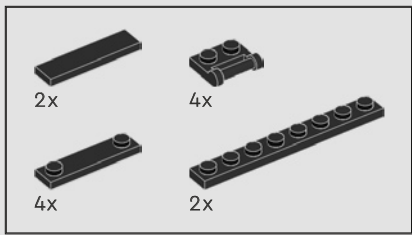

316

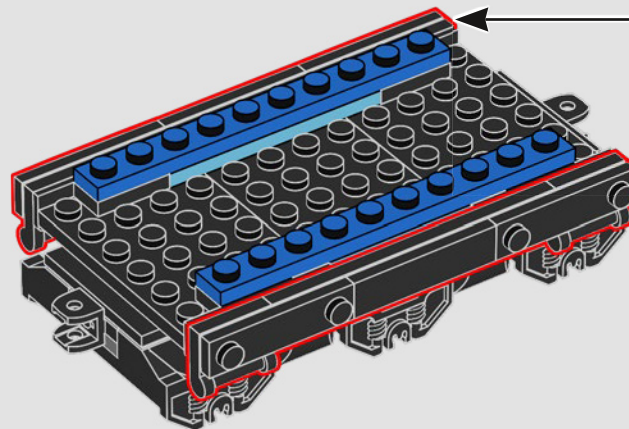
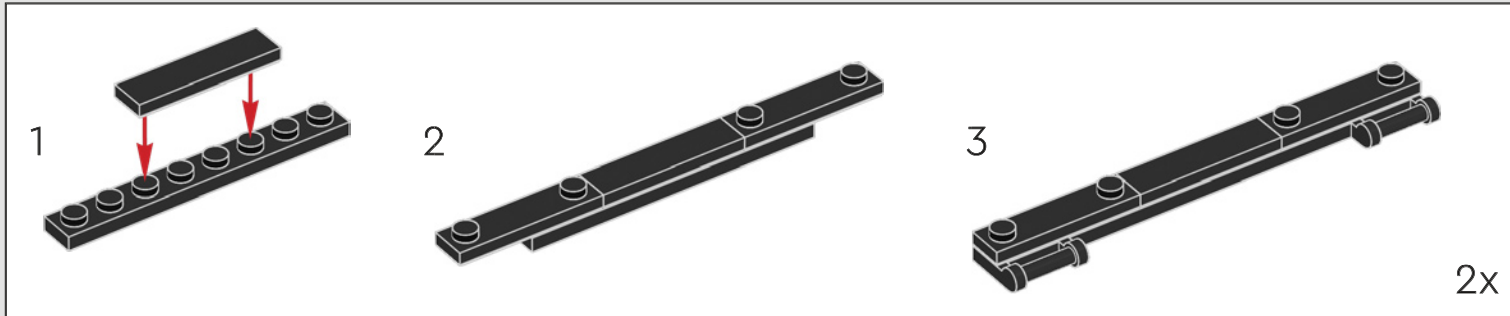

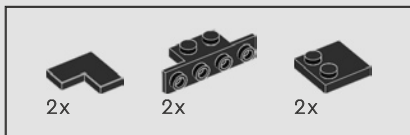

317

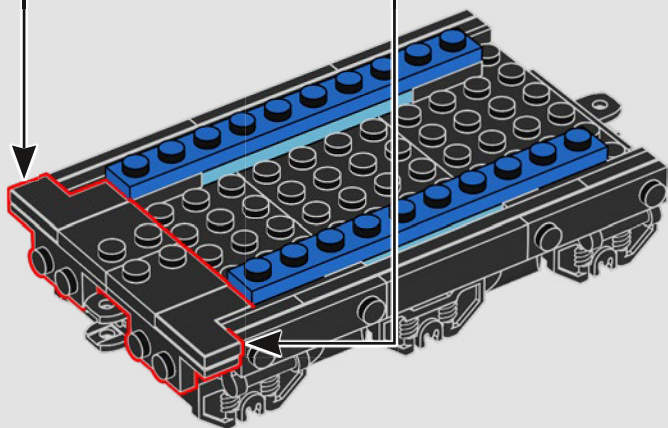
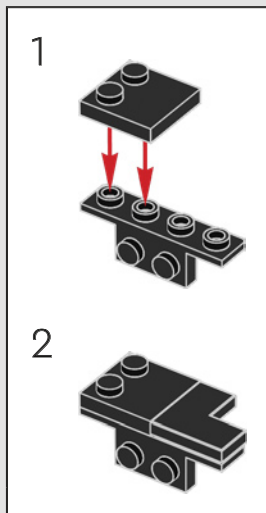
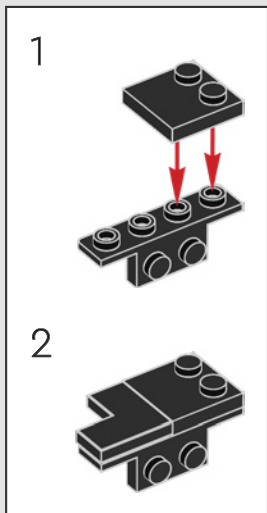

318

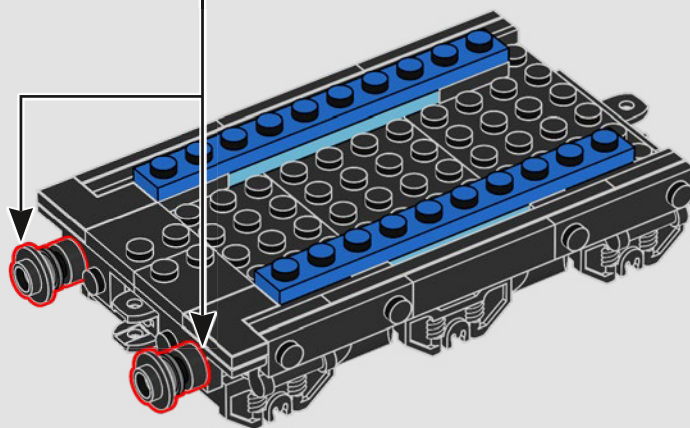
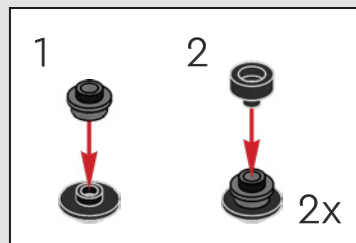

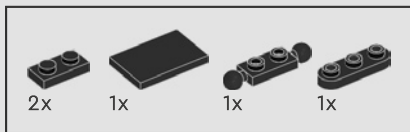

319

“蒸汽继续从发动机中滚滚而出。
煤水车需要很大才能为这样的机车提供燃料。”

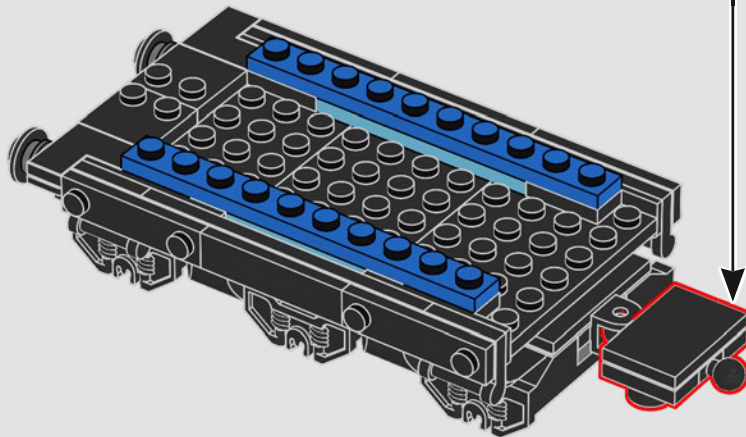
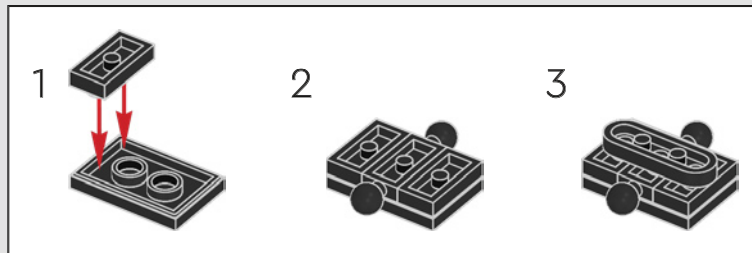

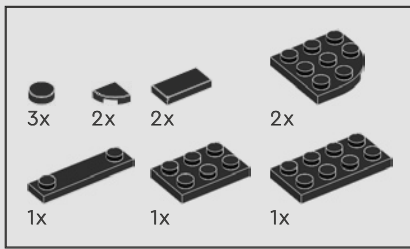

320

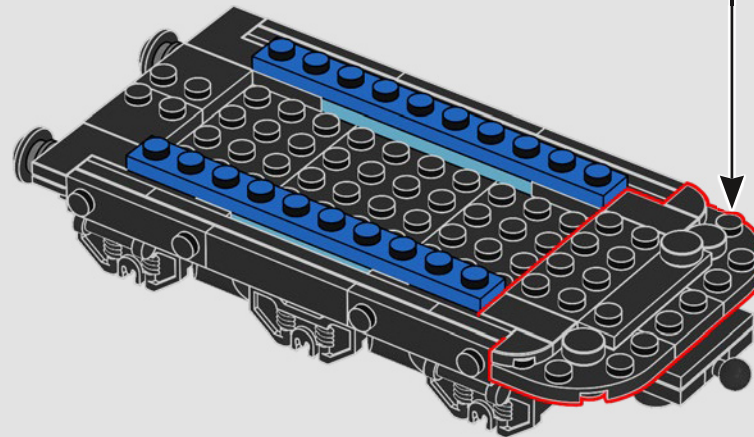
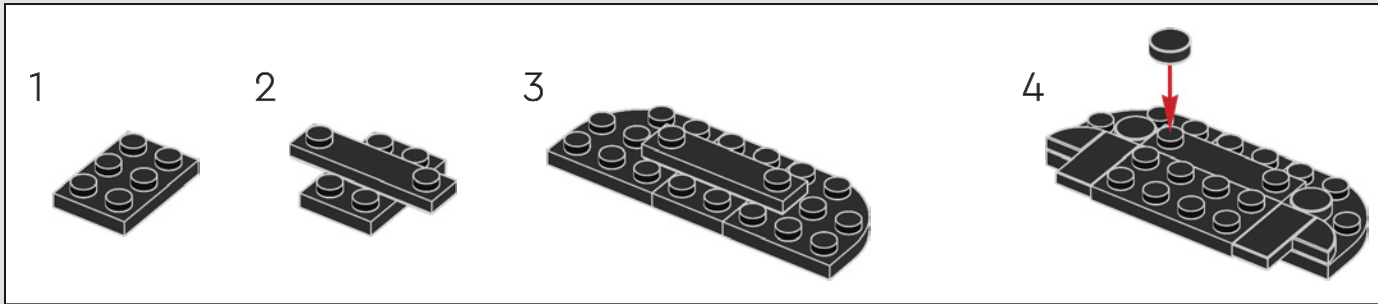

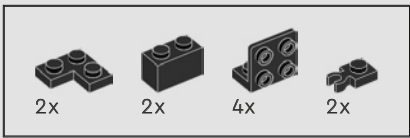

321

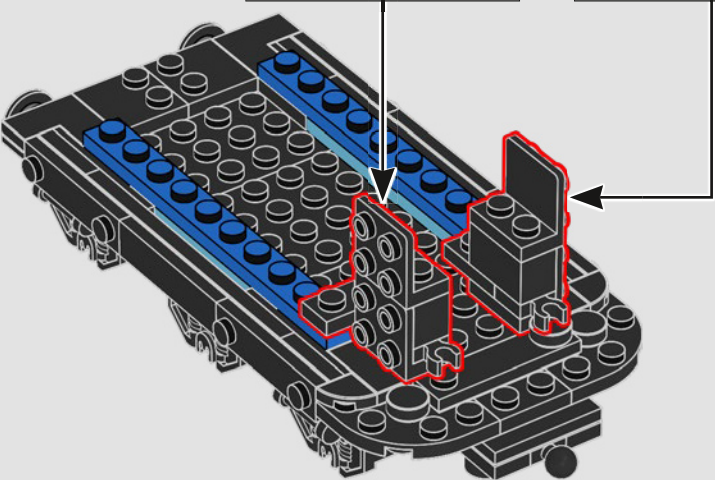
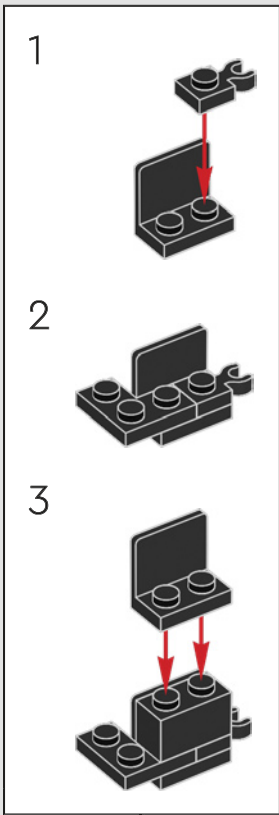
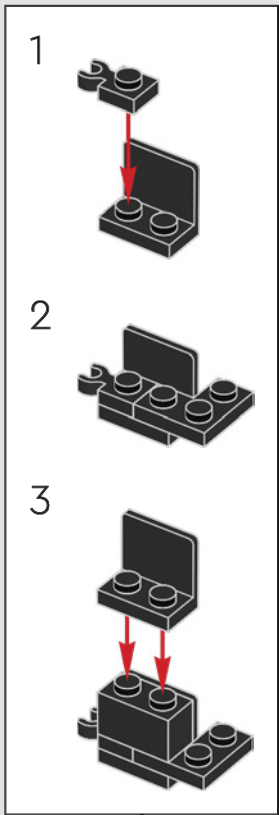



322

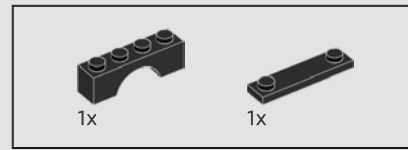
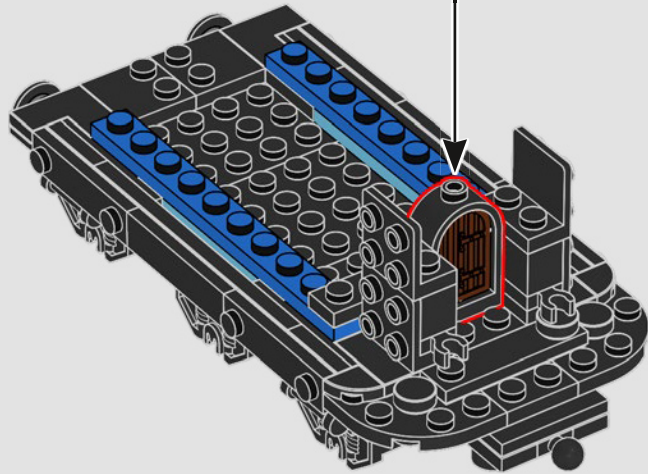
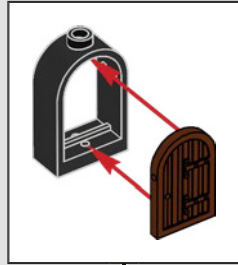

323

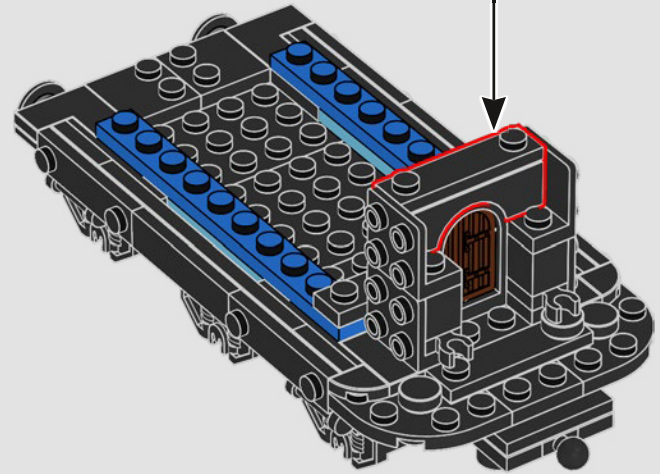
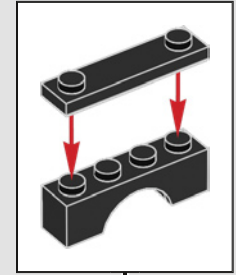

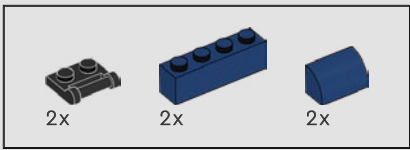

324

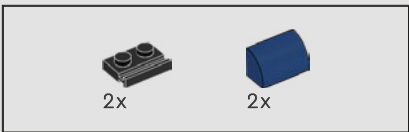
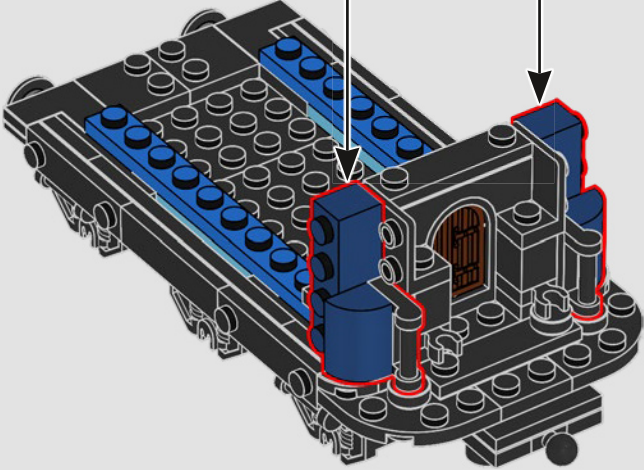
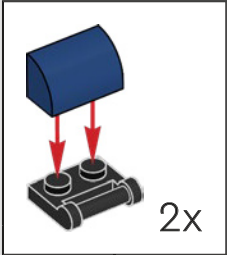

325

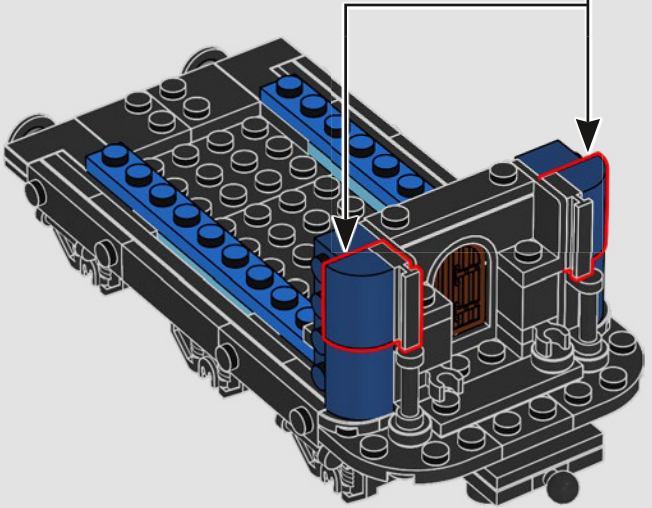
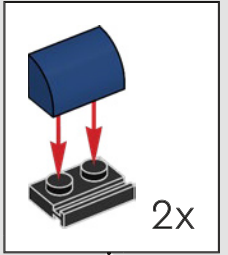



326

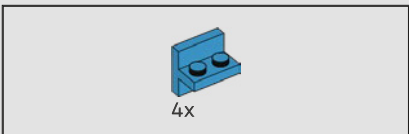
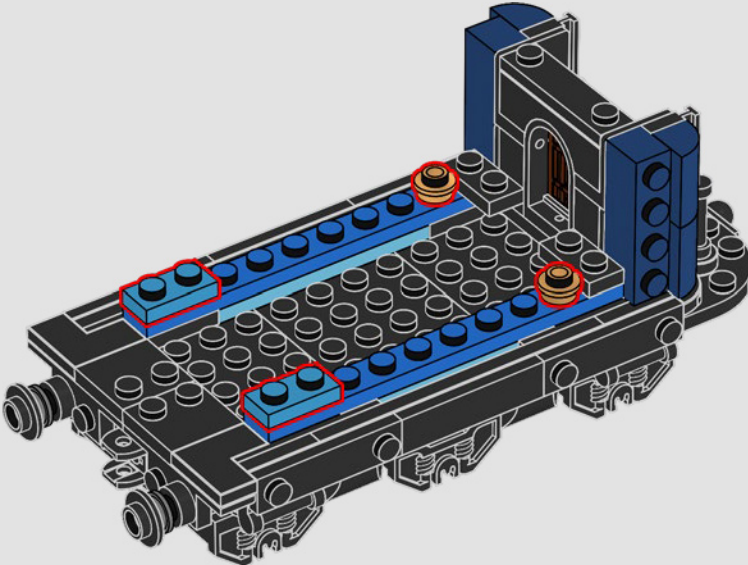

327

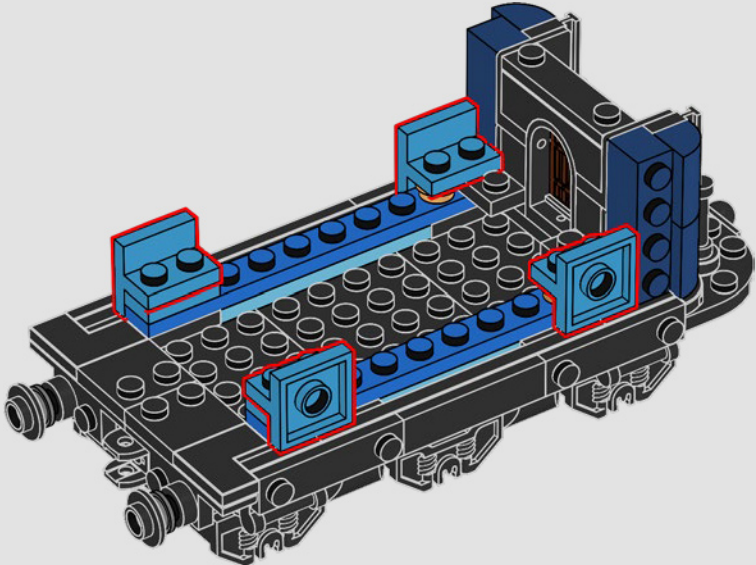



2x

328

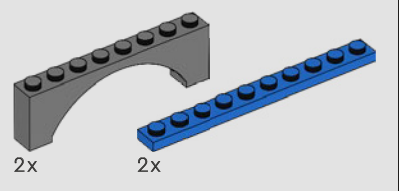
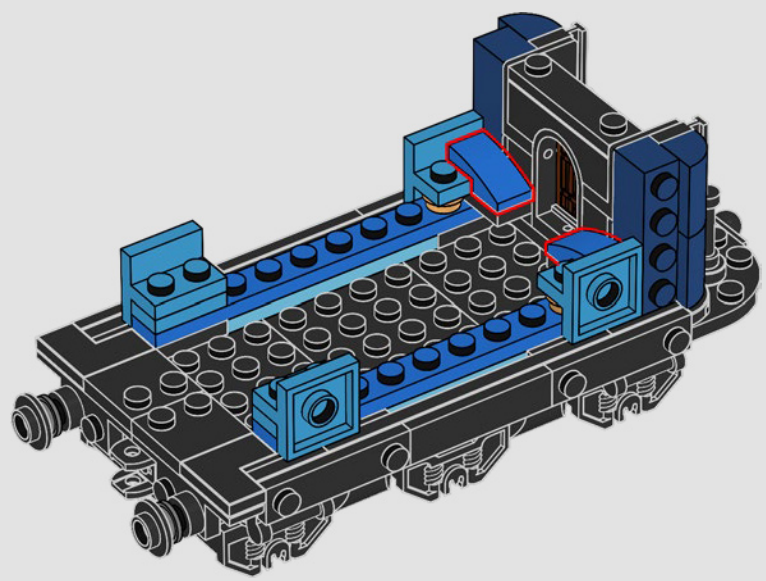

329

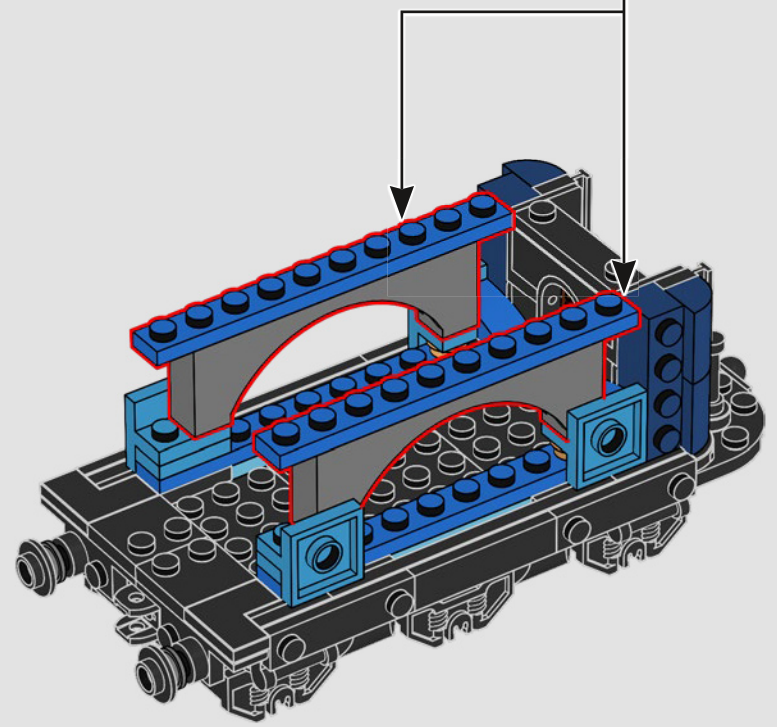
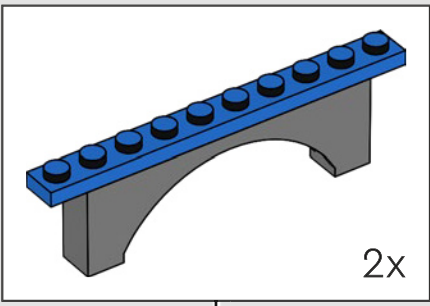

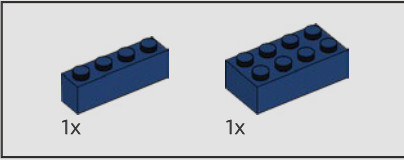
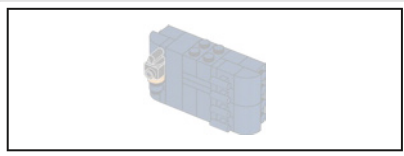

330

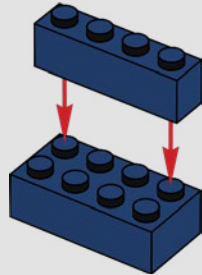

331

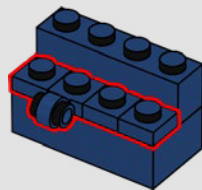

2x

332

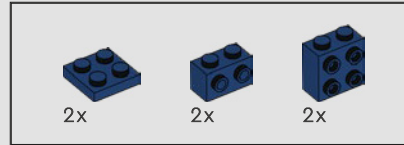
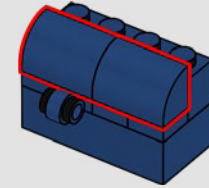

2x

2x

2x

333

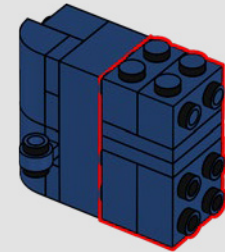
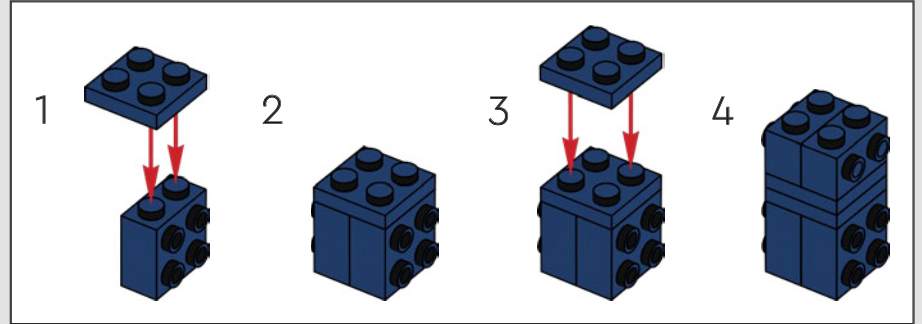

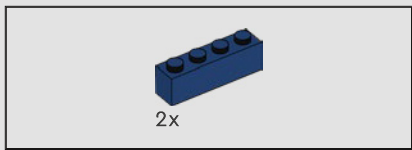

334

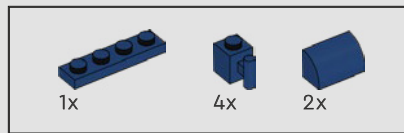
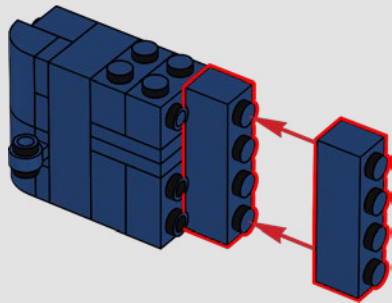

335

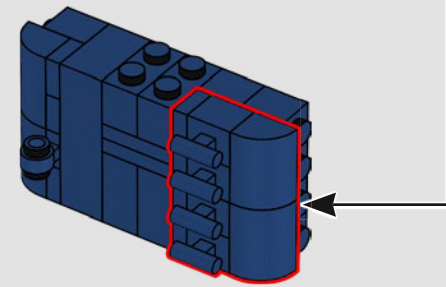
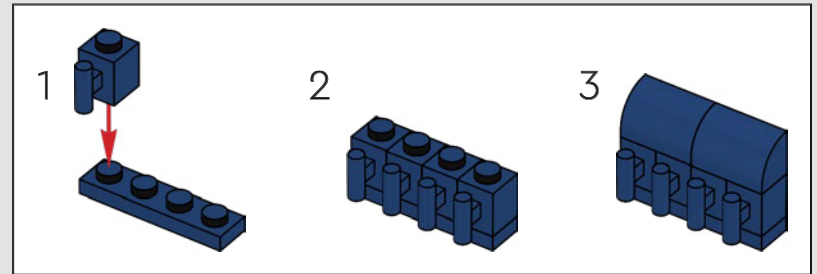



336

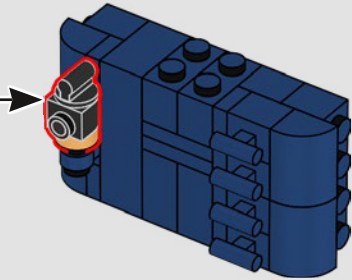
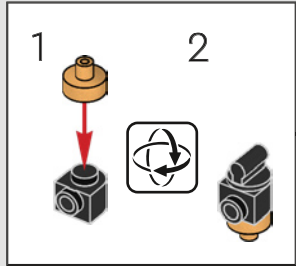

337

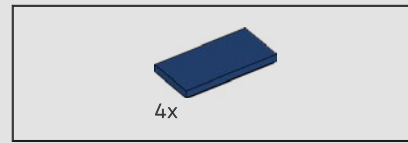
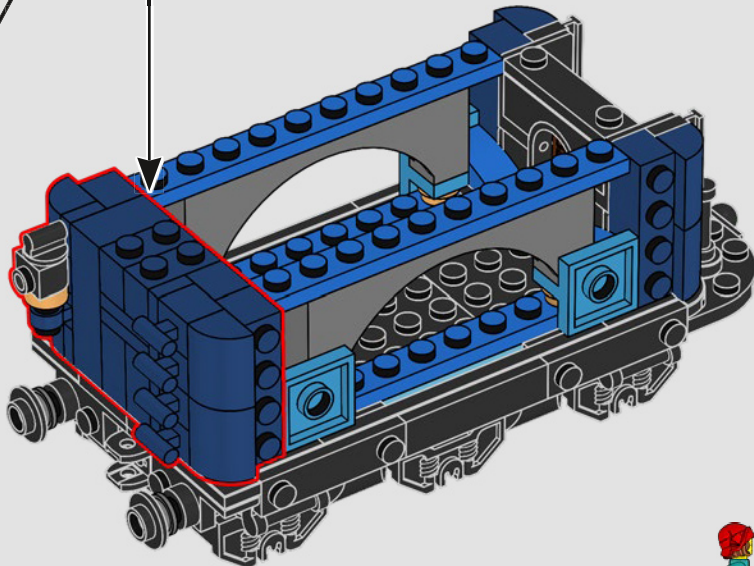

338

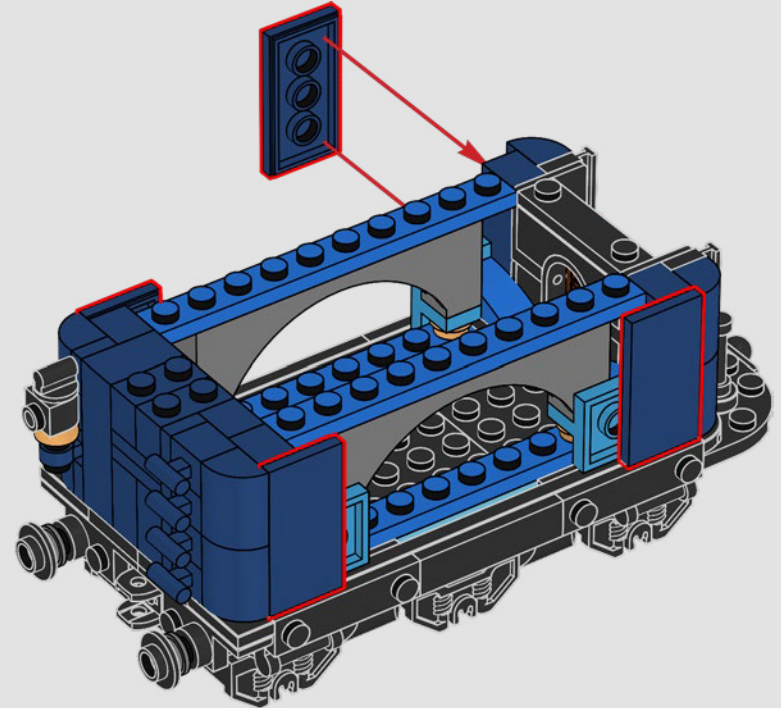

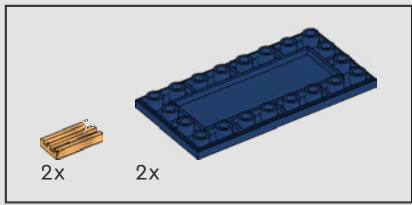

339

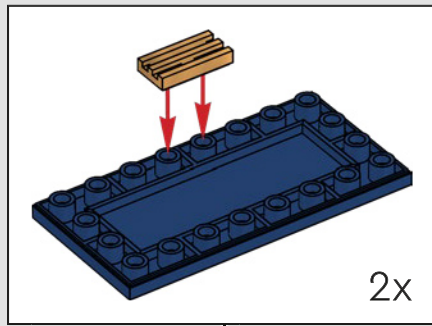

340

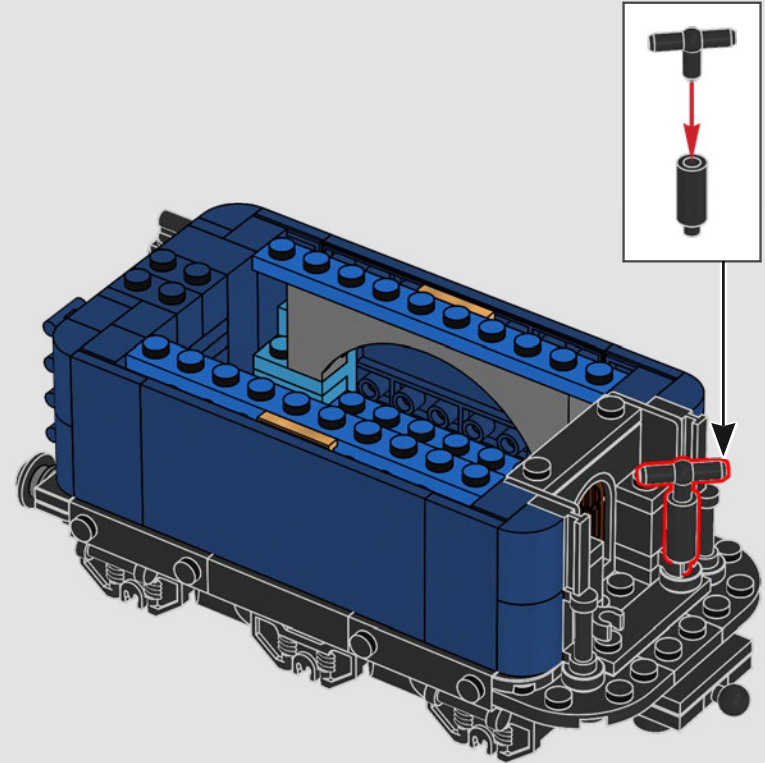
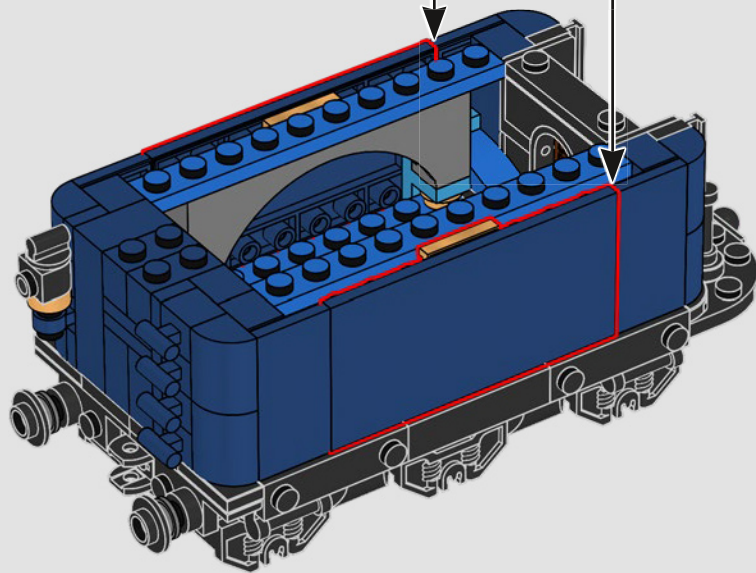

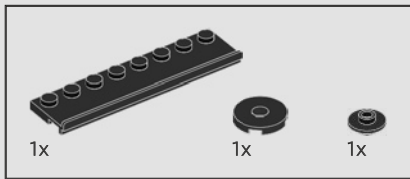

341

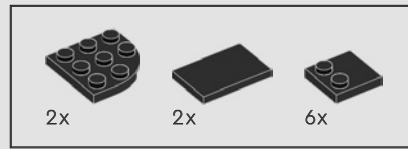
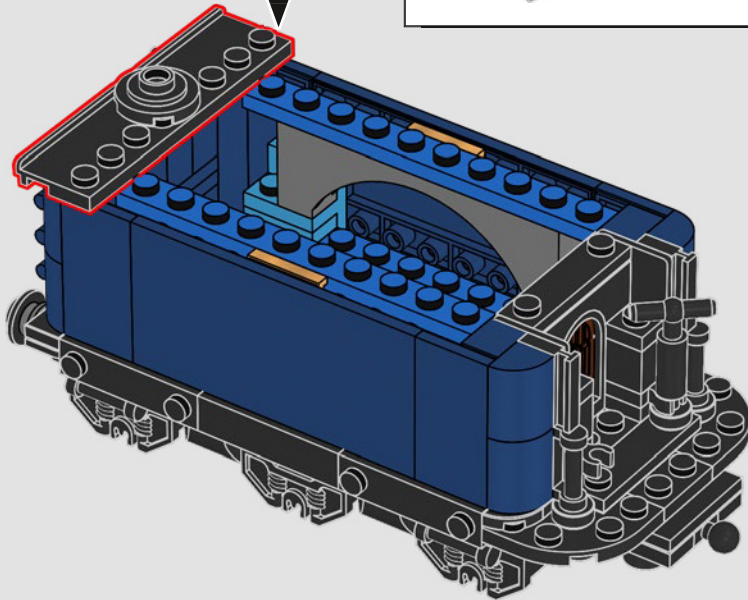
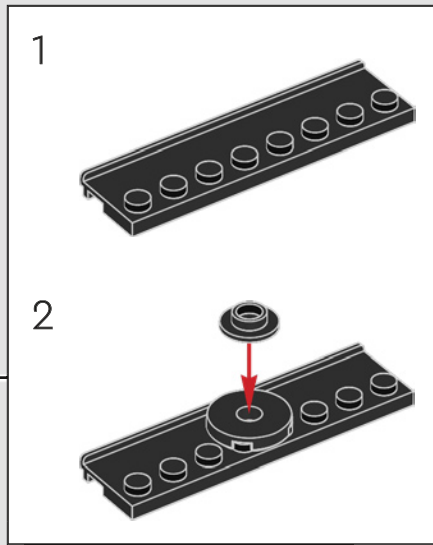

342

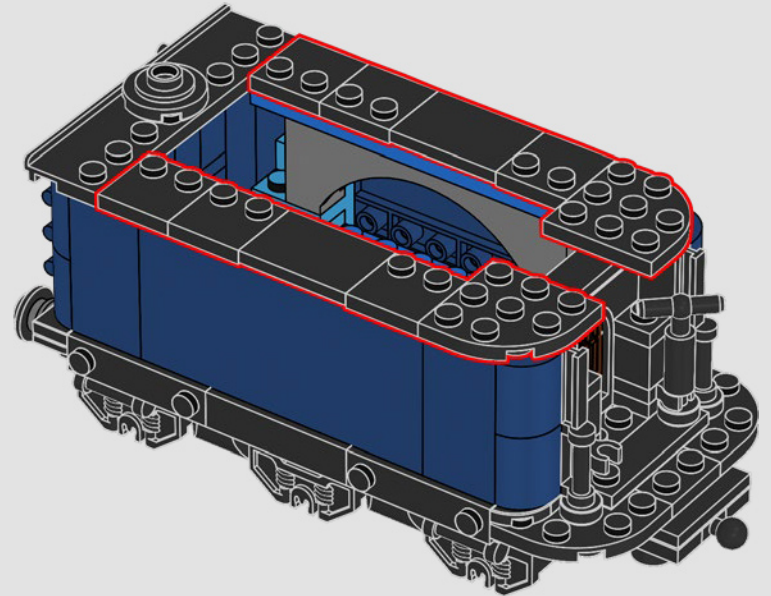

5

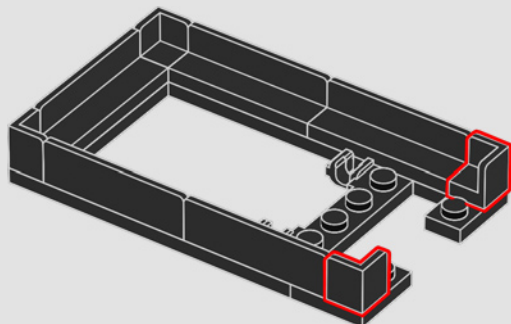

6

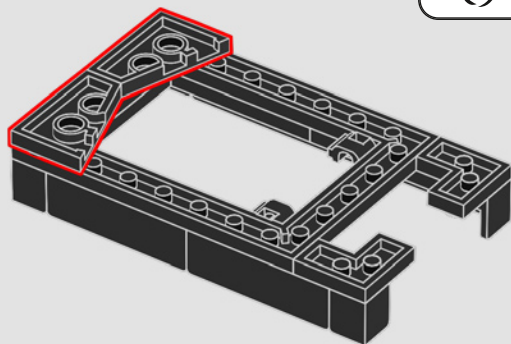

7

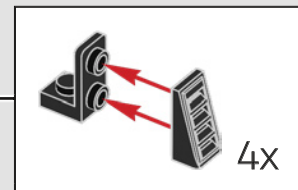
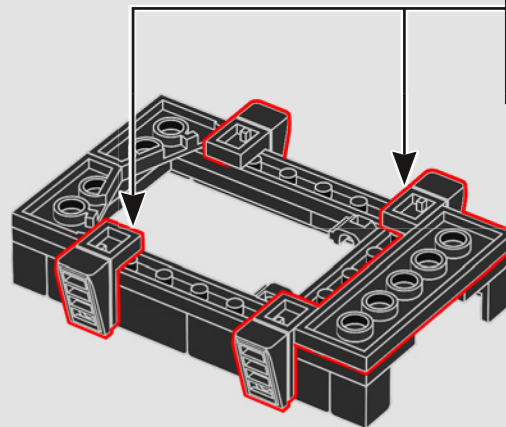

8

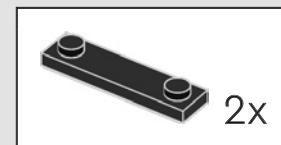
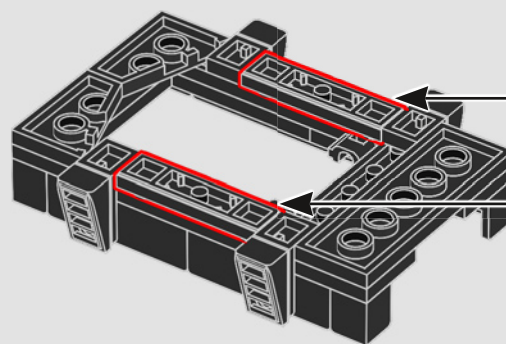



9

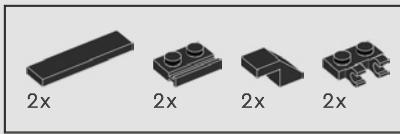
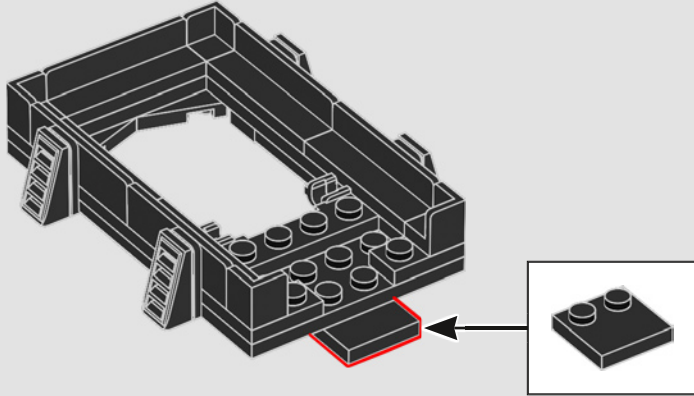

344

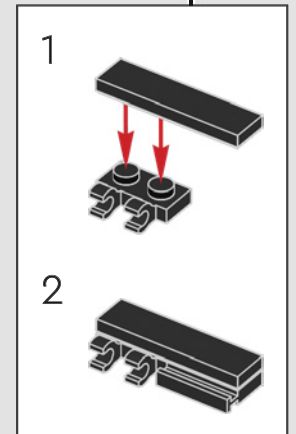
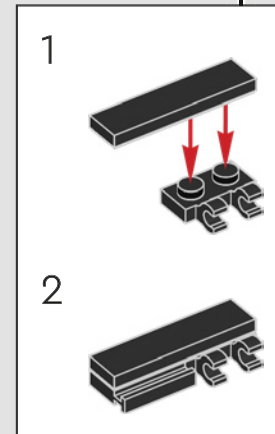
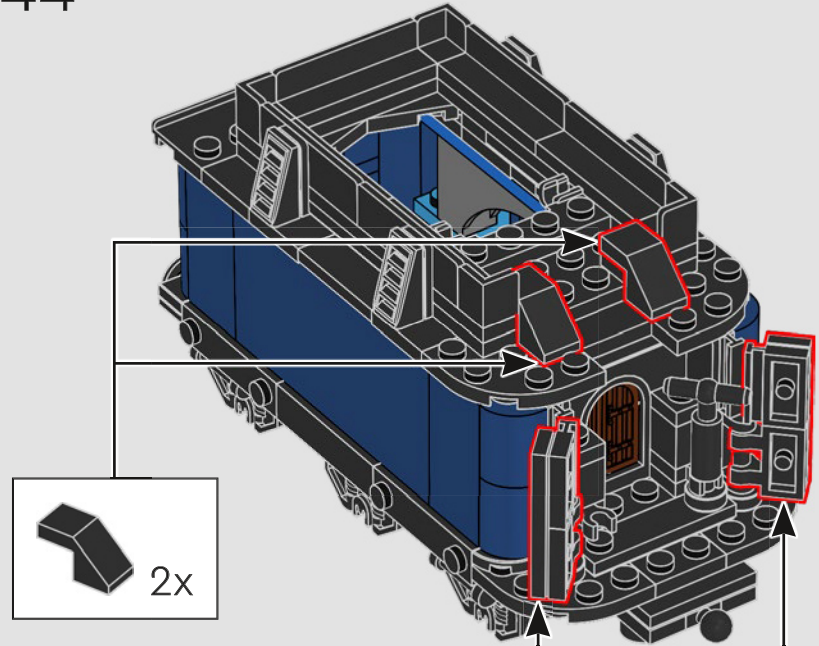



345

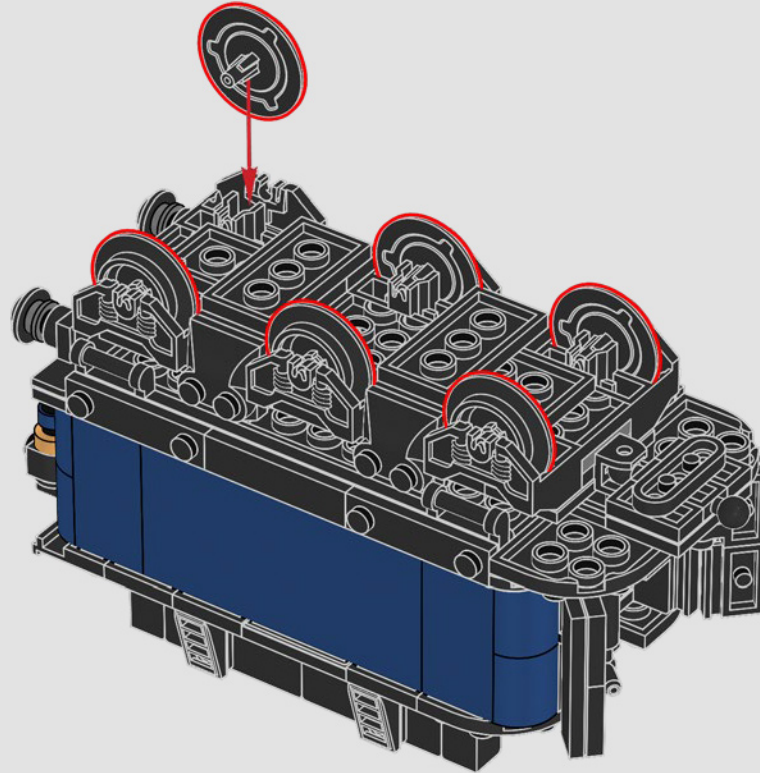

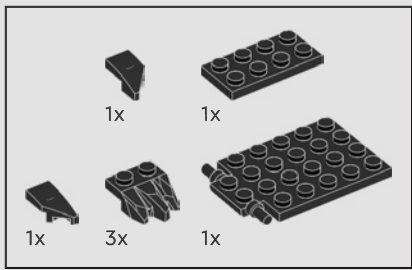

346

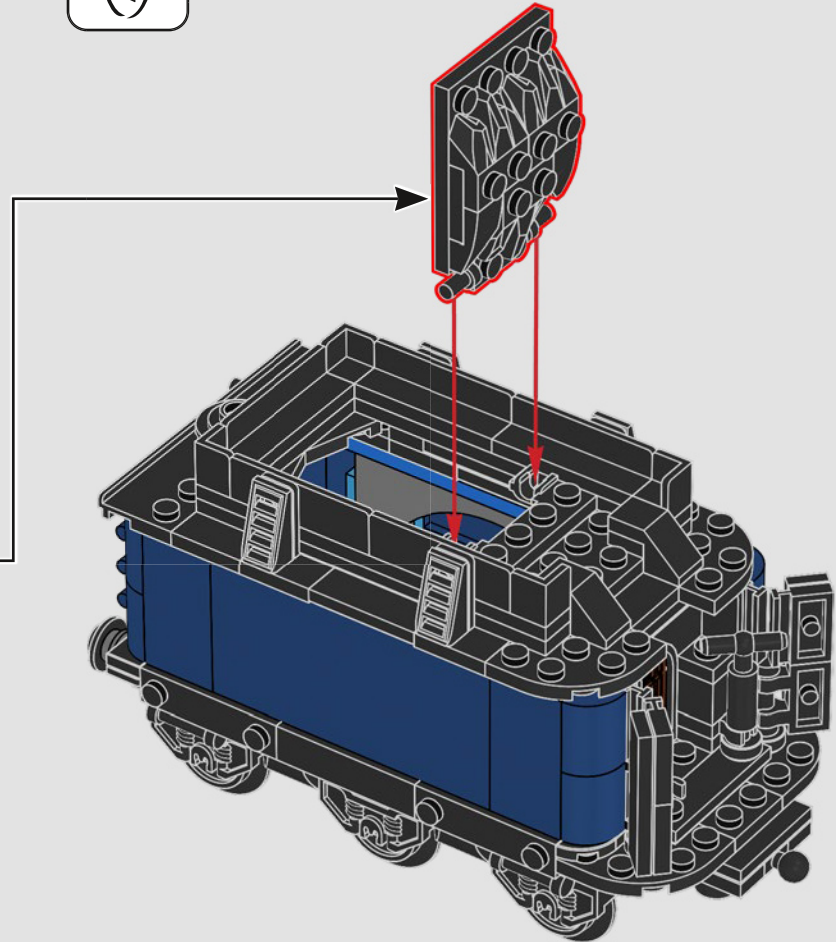
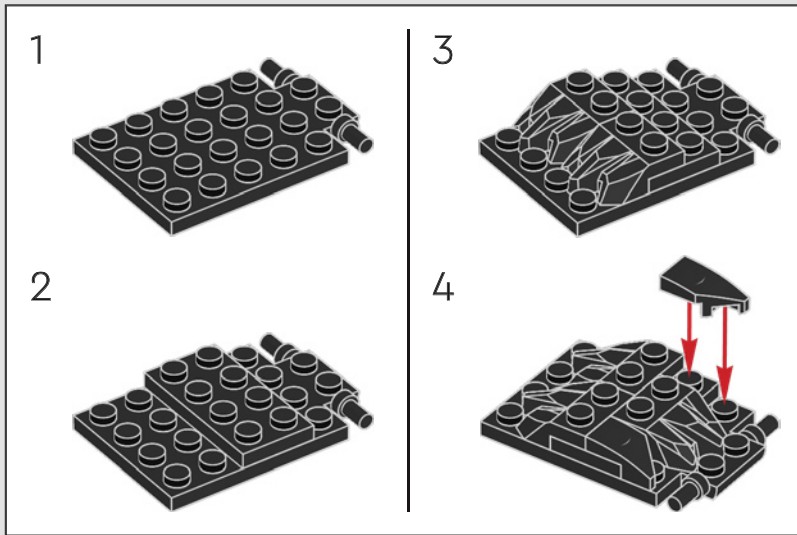

347



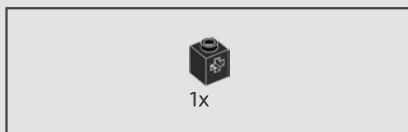
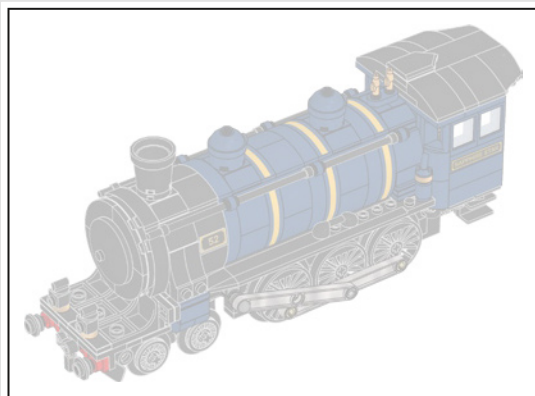
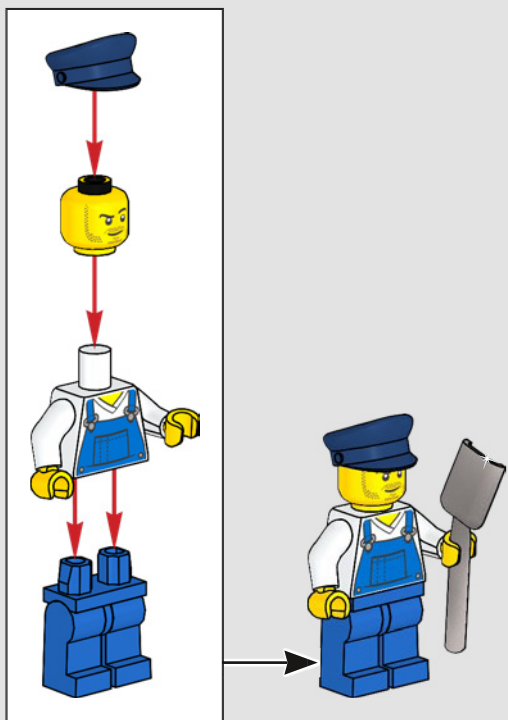

348

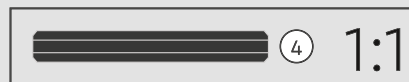
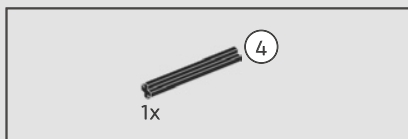

349

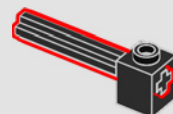

“在我们的整个旅程中，火车司机点燃了火，并使发动机保持运转良好。”



350

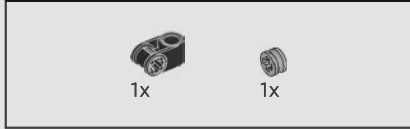
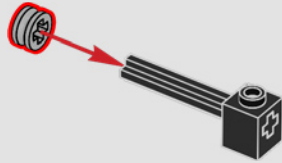

351

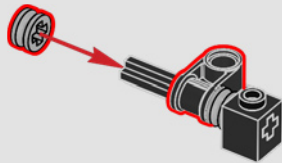

352

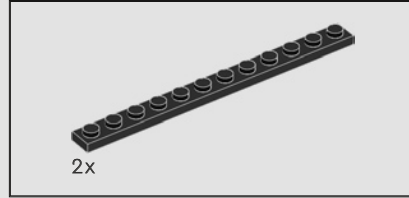
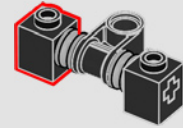

353

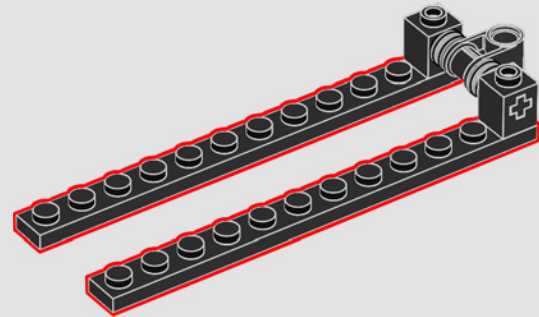

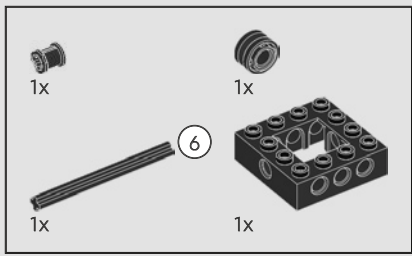

354

1

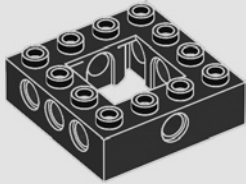

2

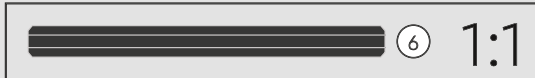
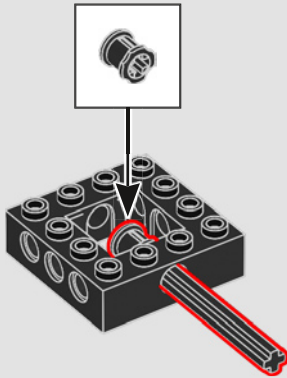

3

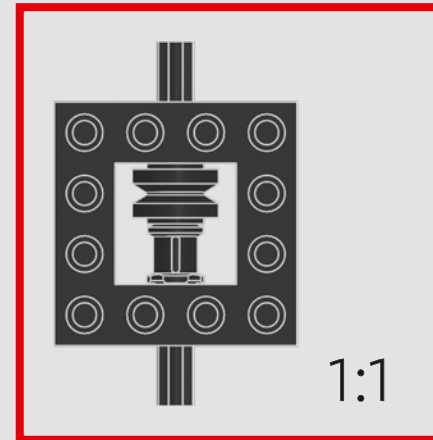
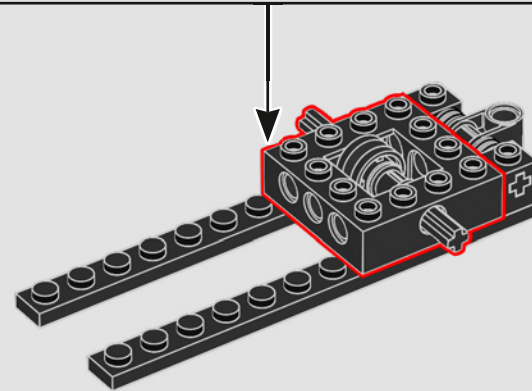
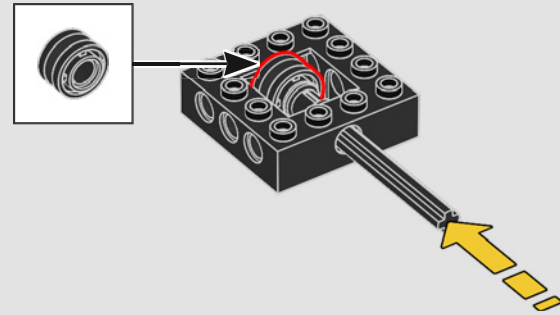

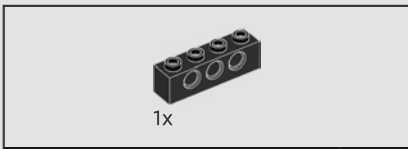

355

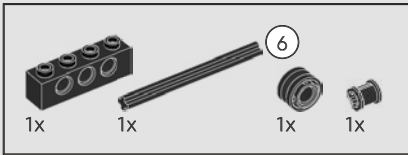
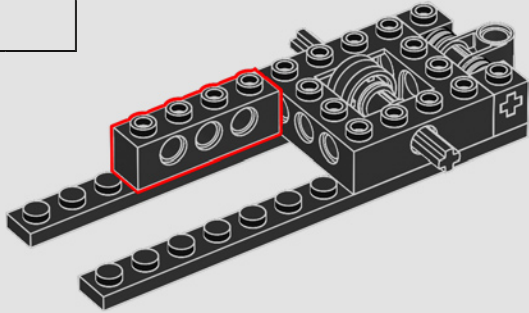

356

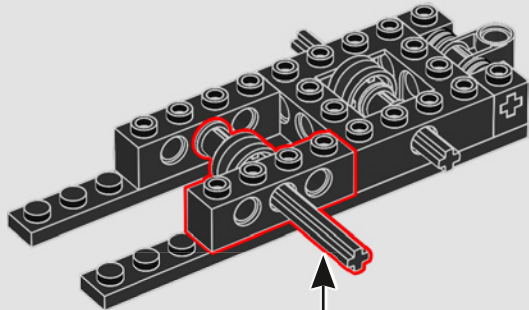
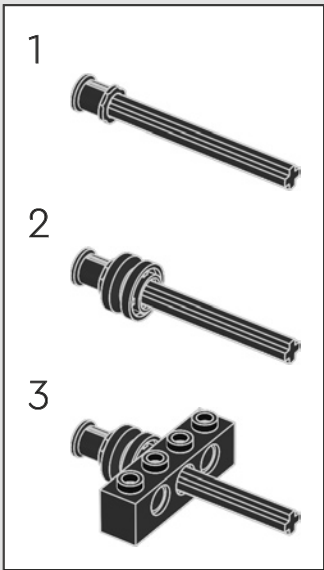

357

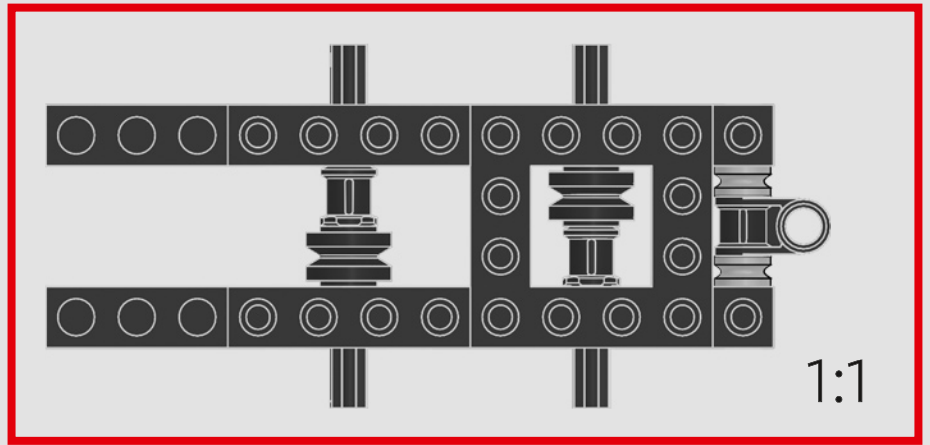
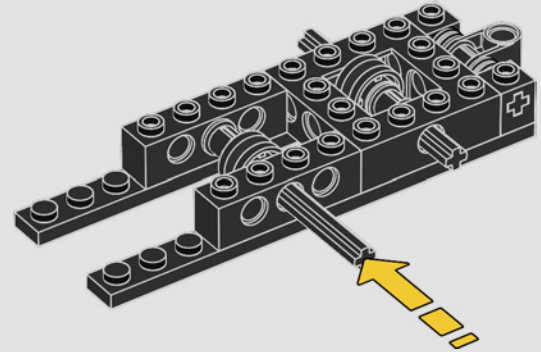

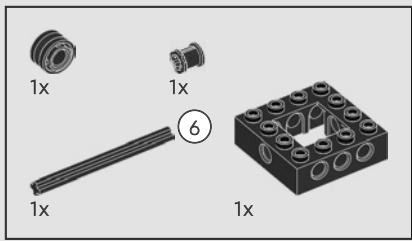

358

1

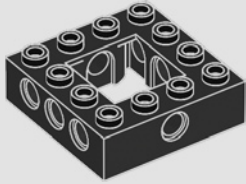

2

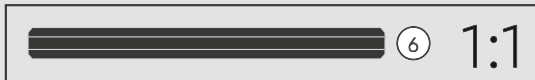
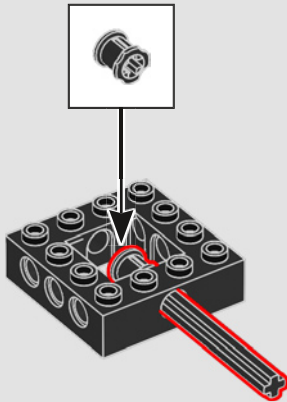

3

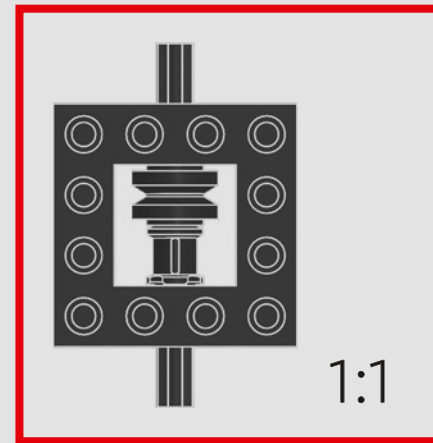
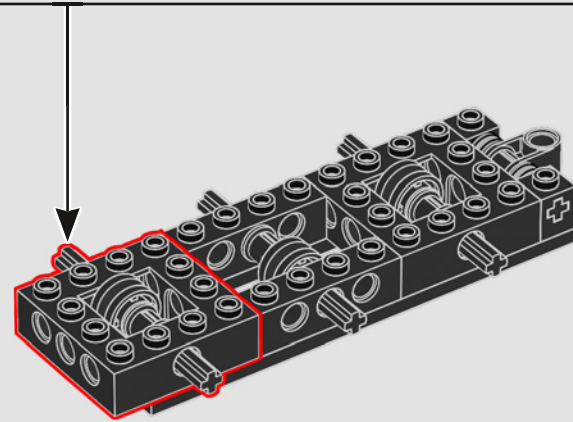
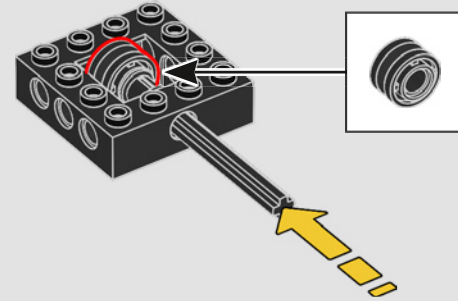

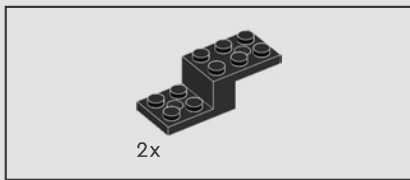

359

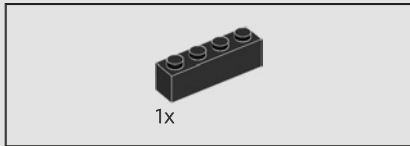
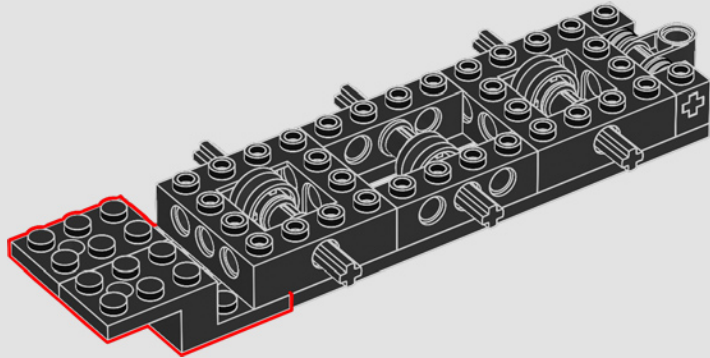

360

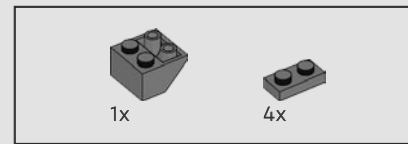
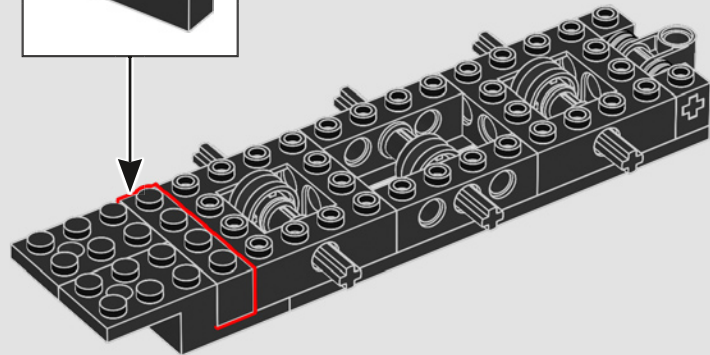
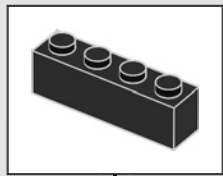

361

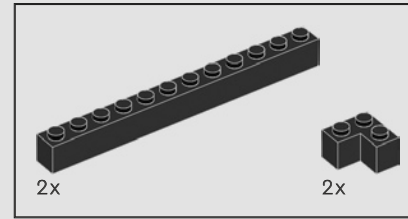
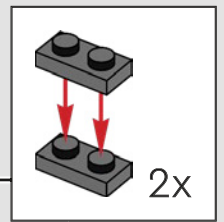
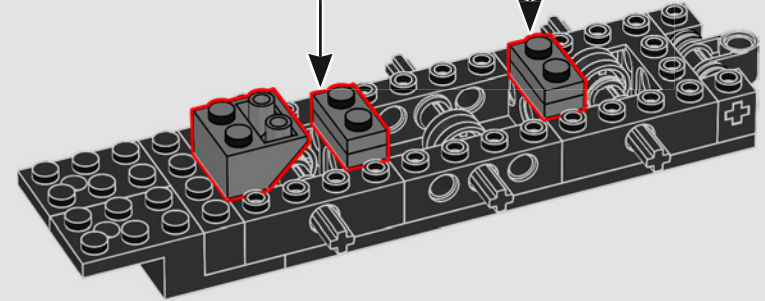

362

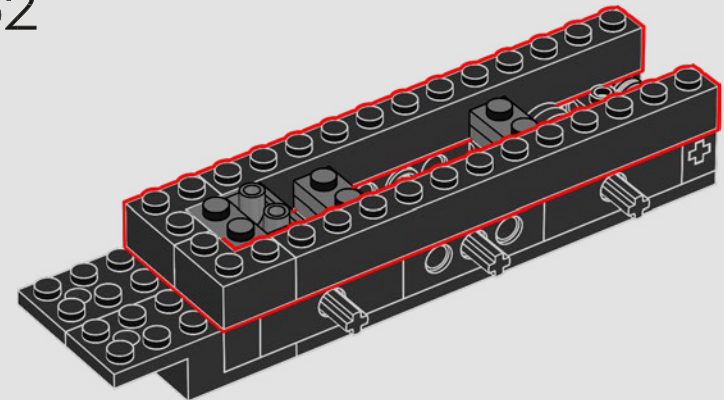

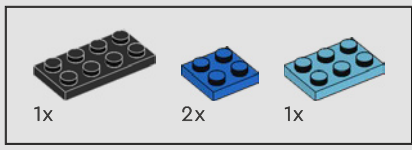

363

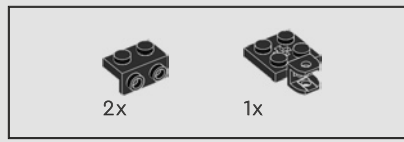
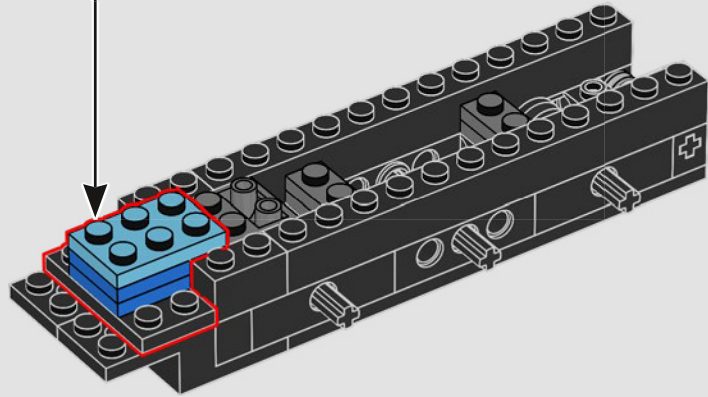
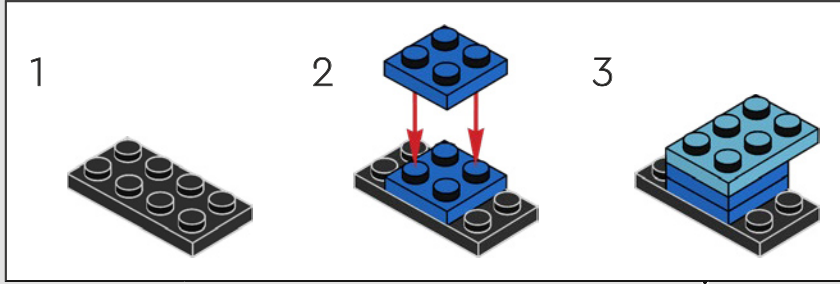

364

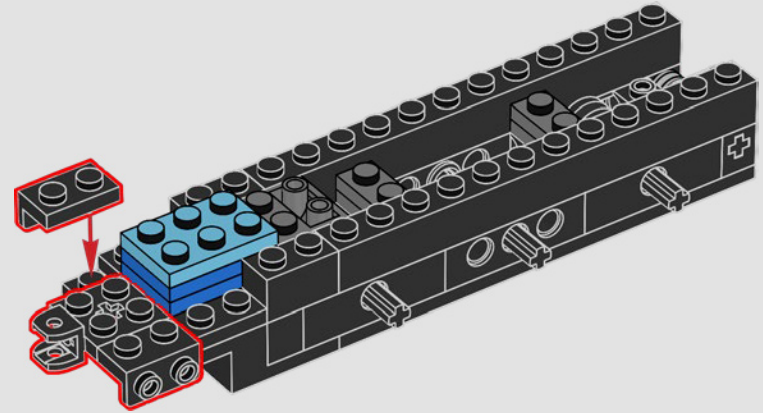

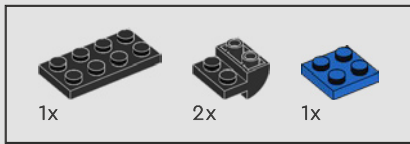

365

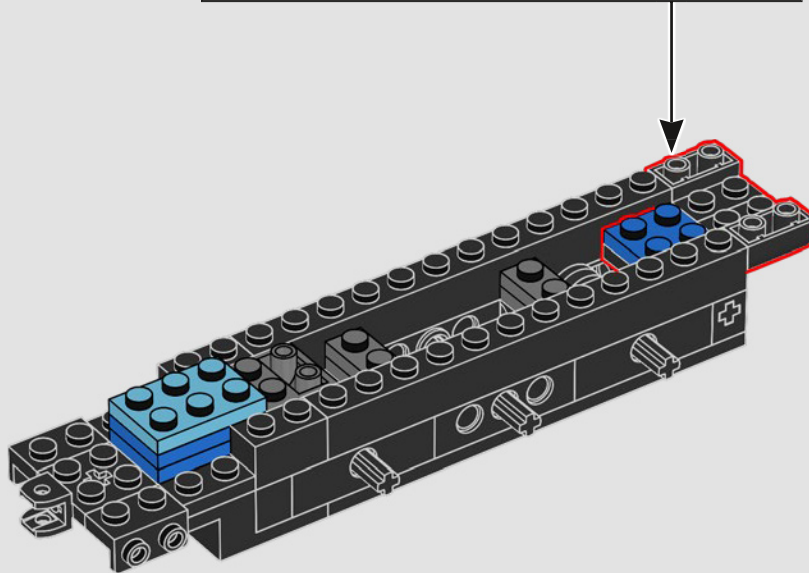
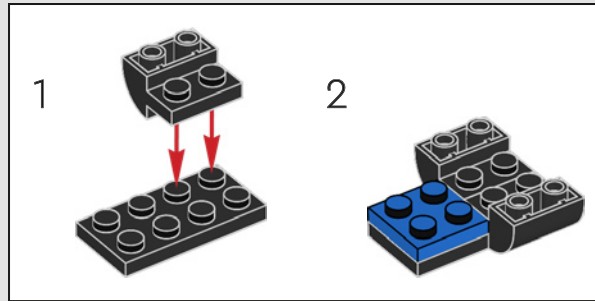

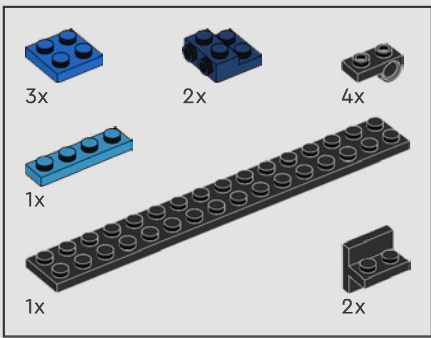

366

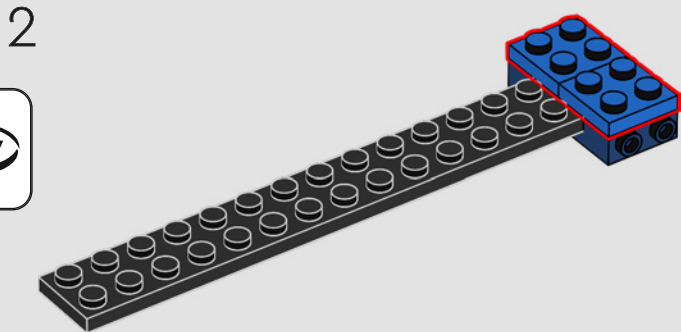
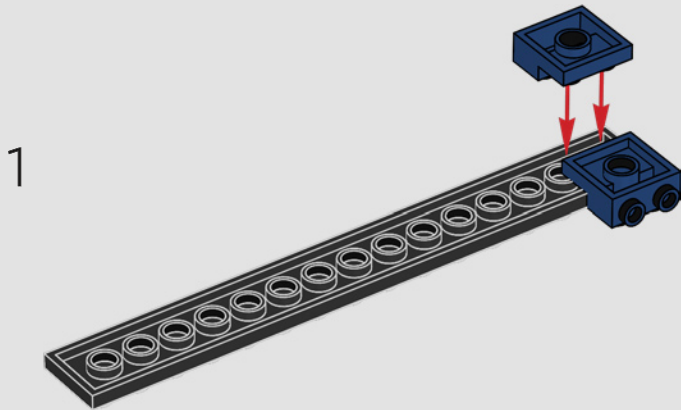

3

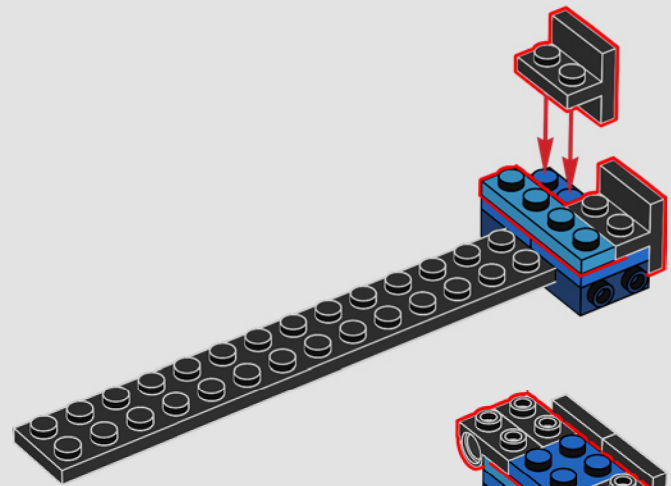

4

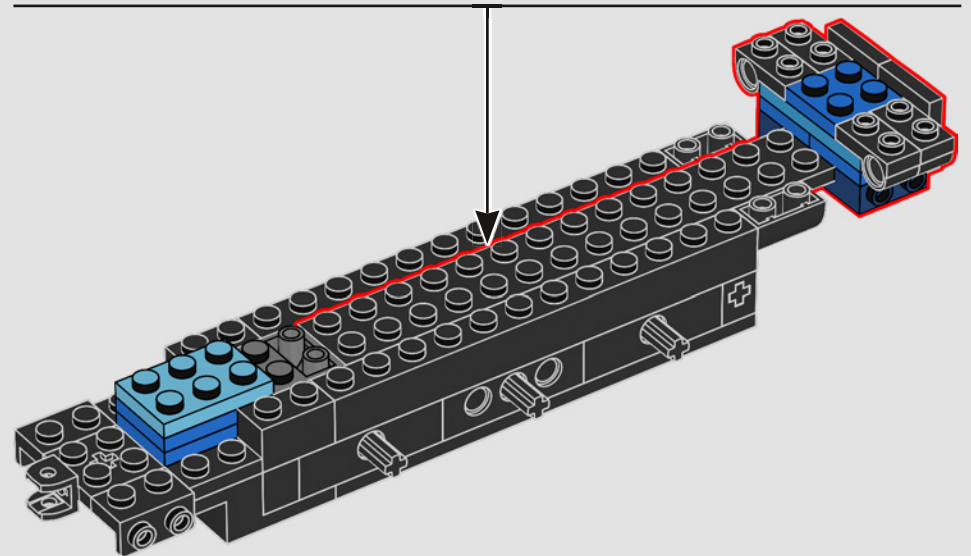
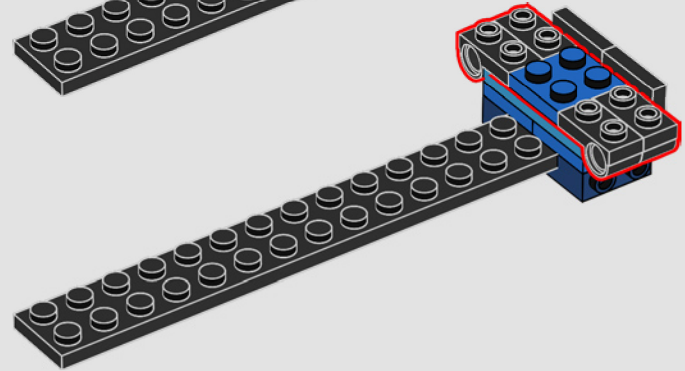

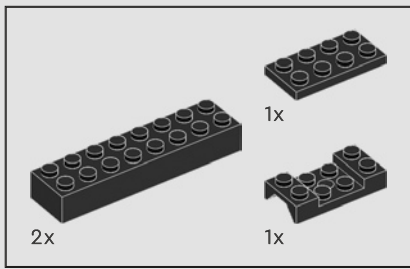

367

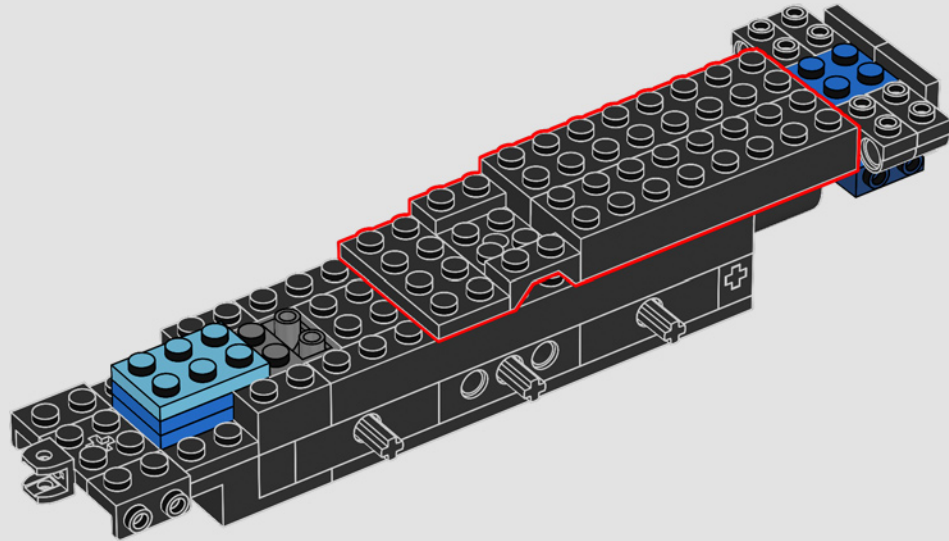

368

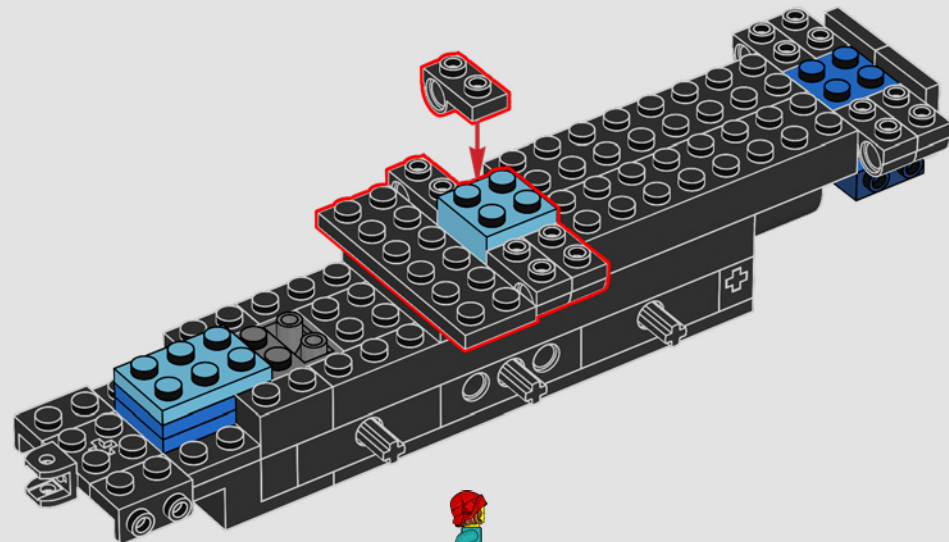

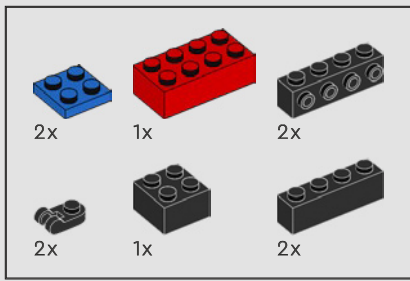

369

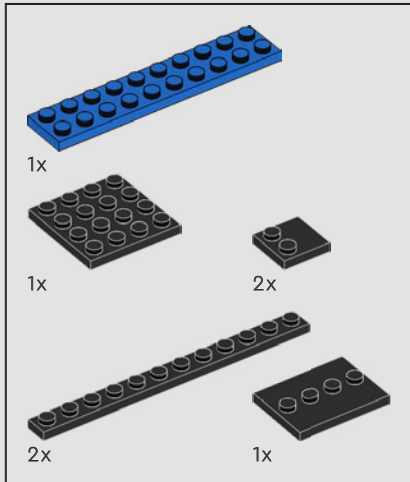
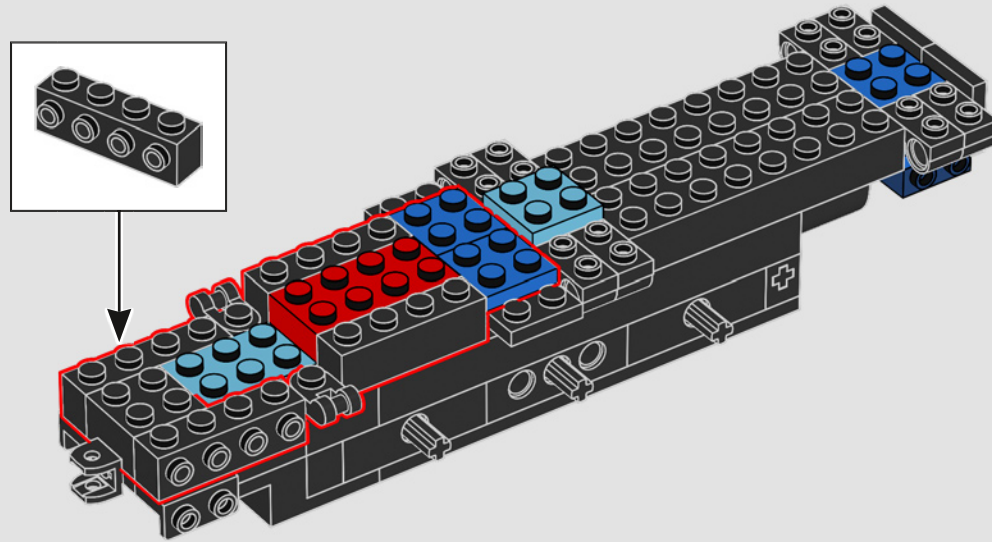

370

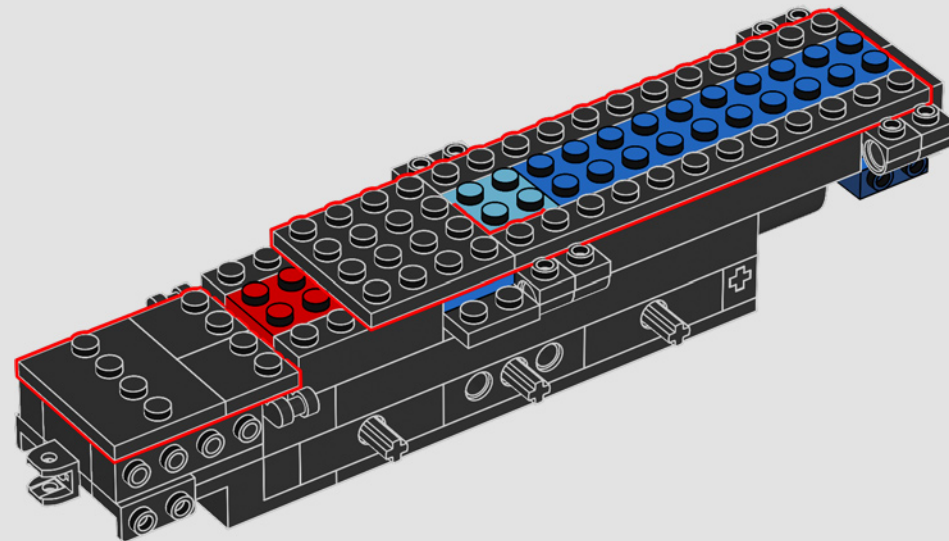



371

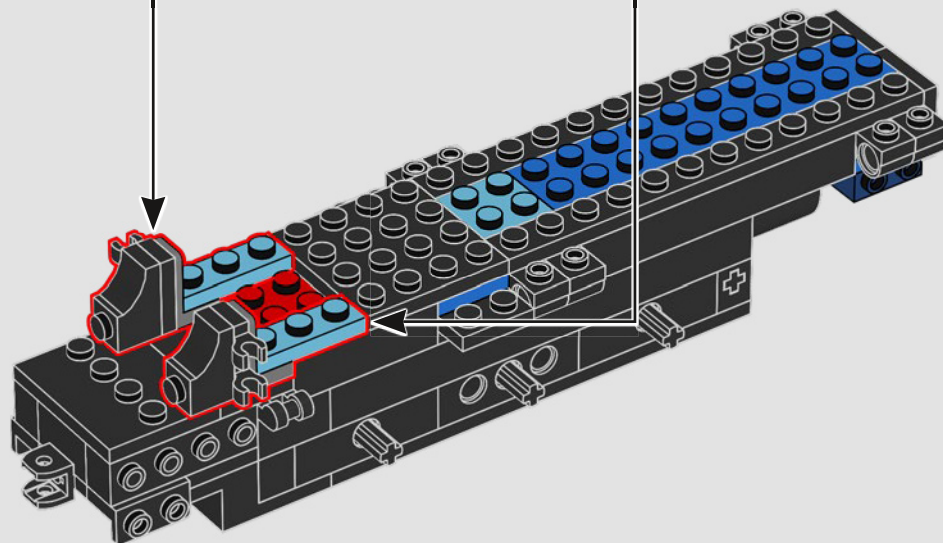
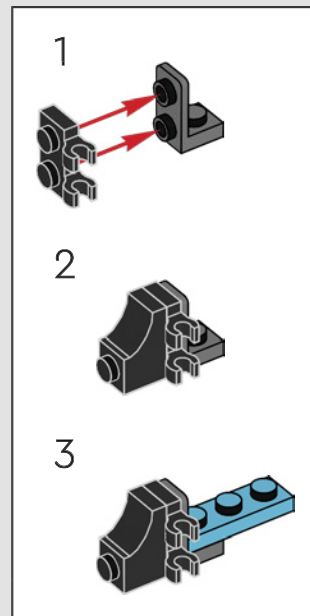
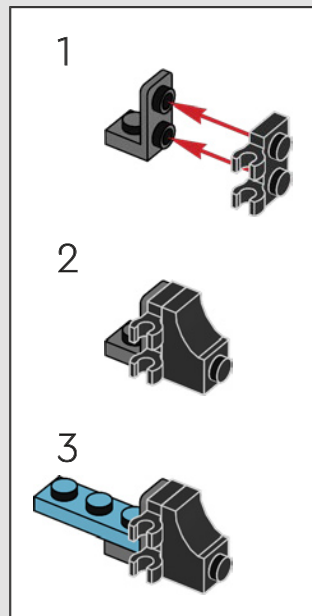

下一站:索非亚
“全速前进, 穿过巴尔干山脉,
前往我们的下一站。”



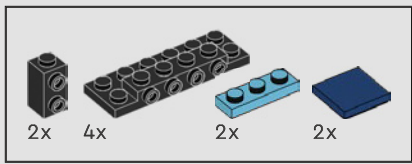

372

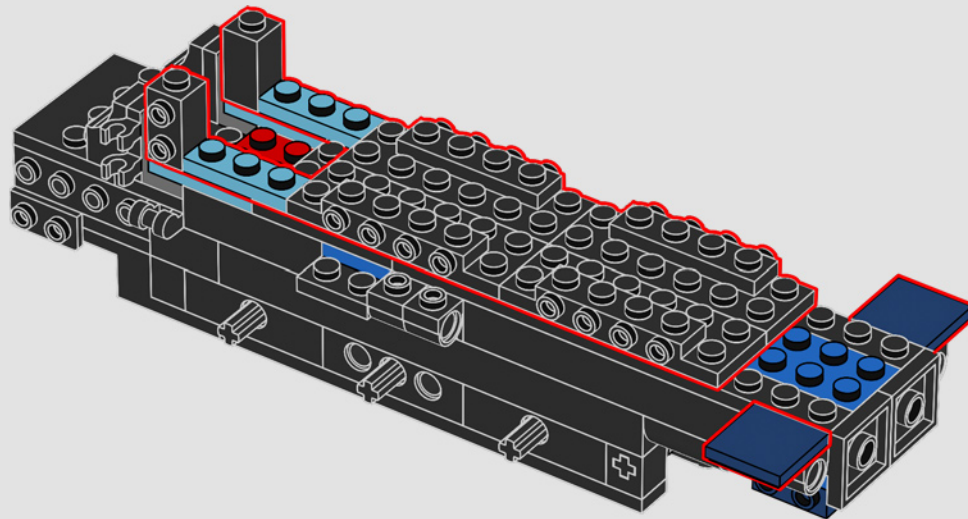

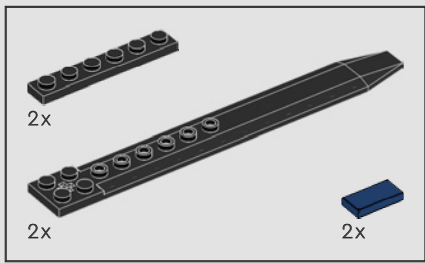

373

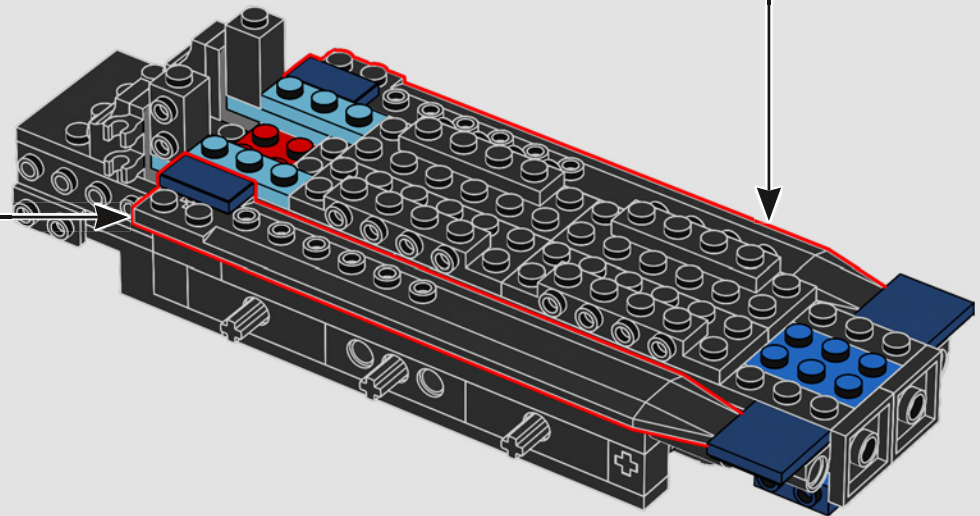
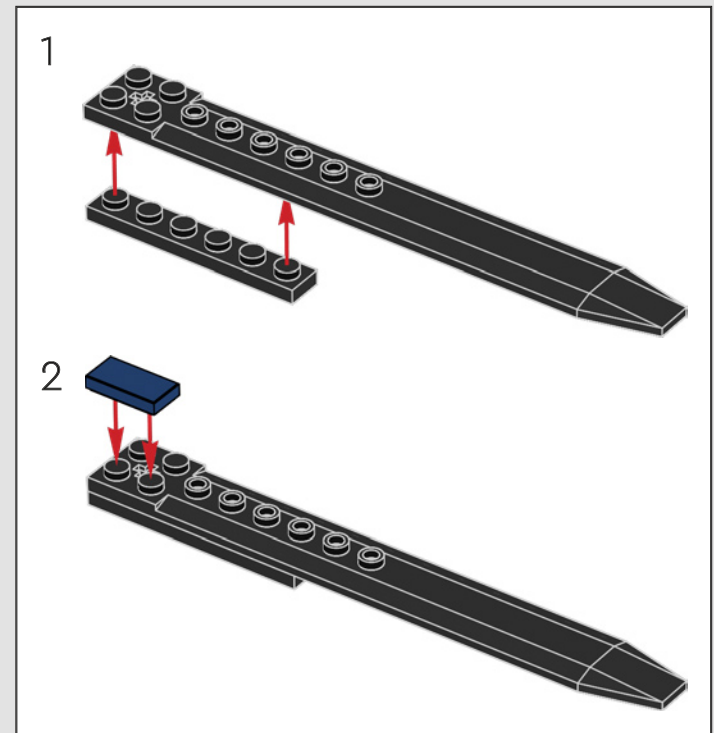
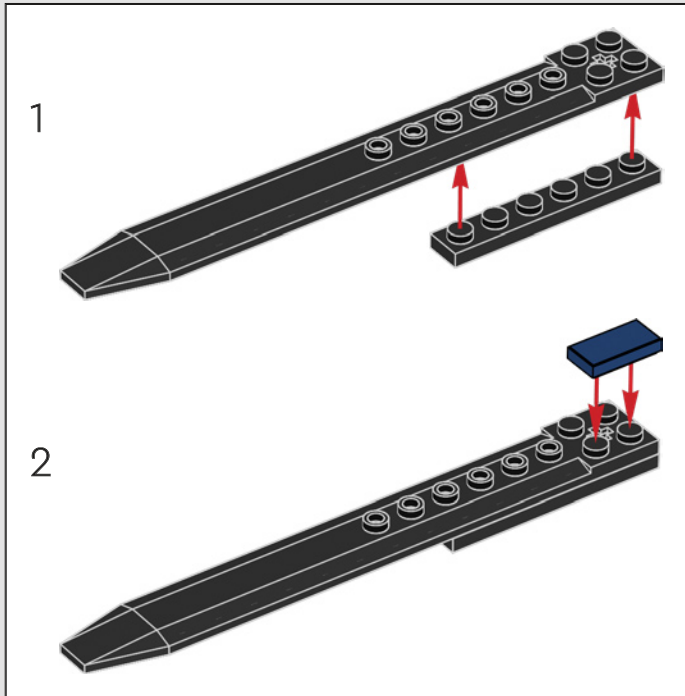

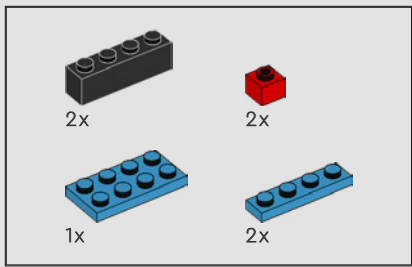

374

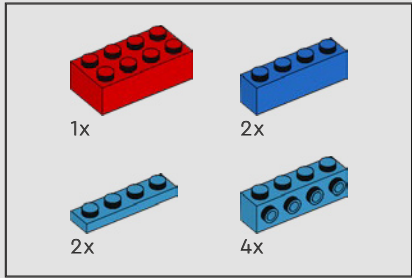
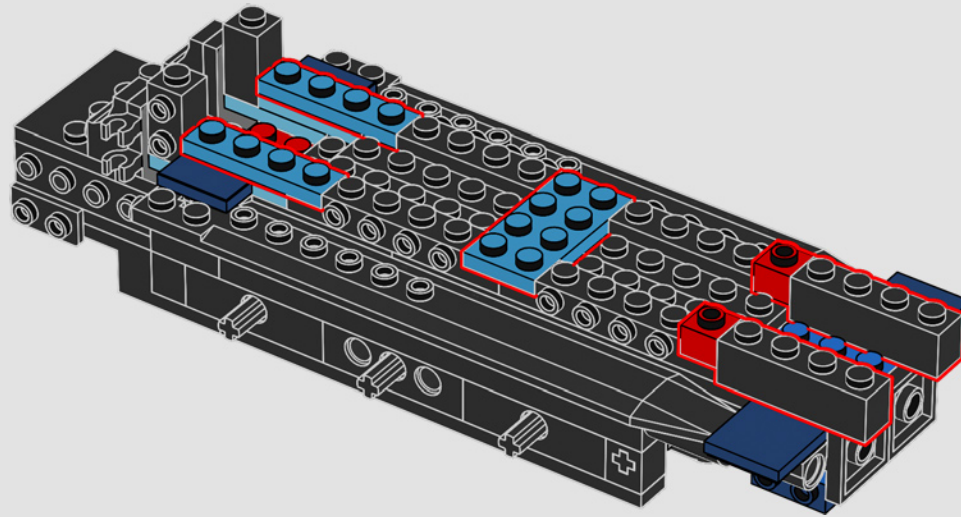

375

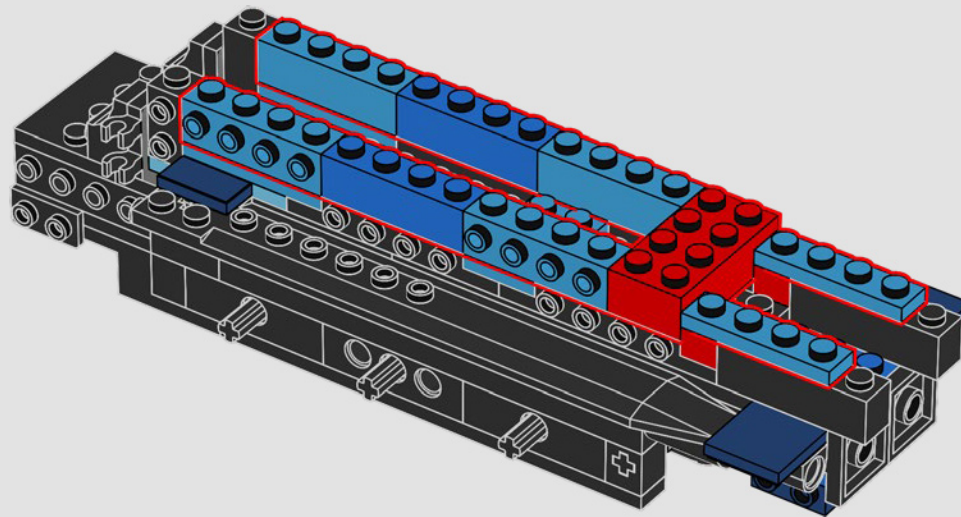

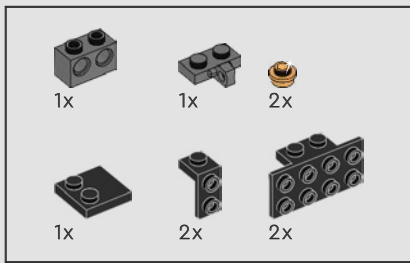

376

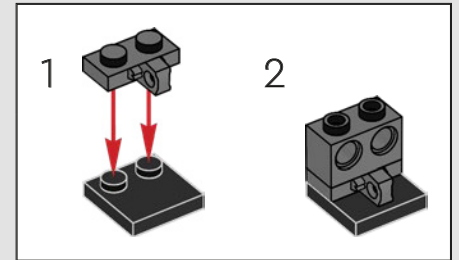
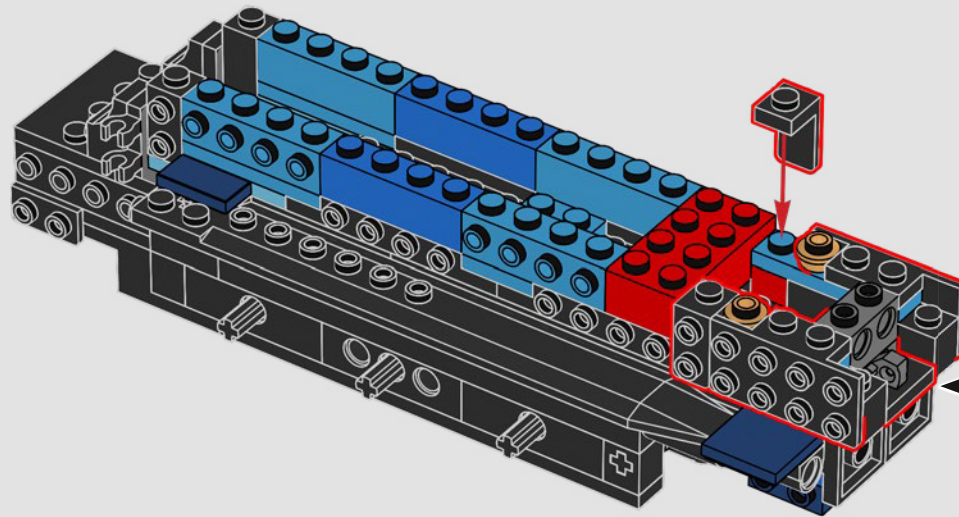

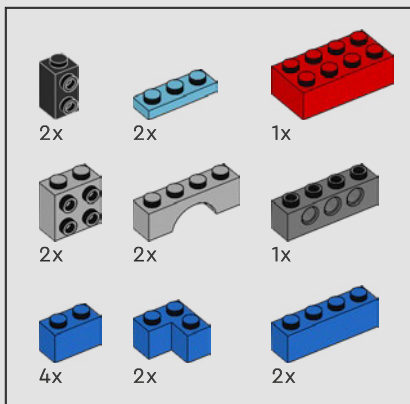

377

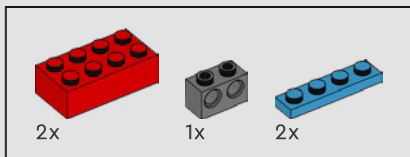
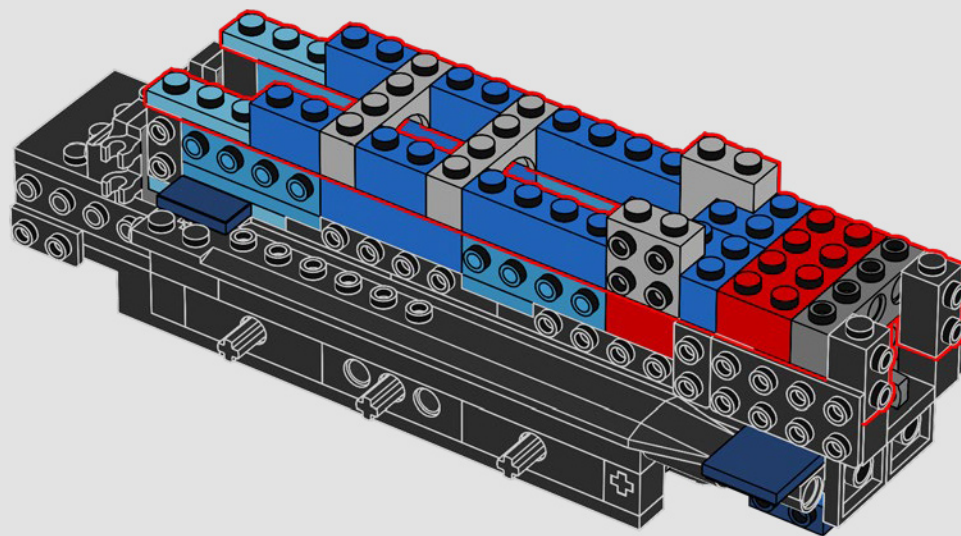

378

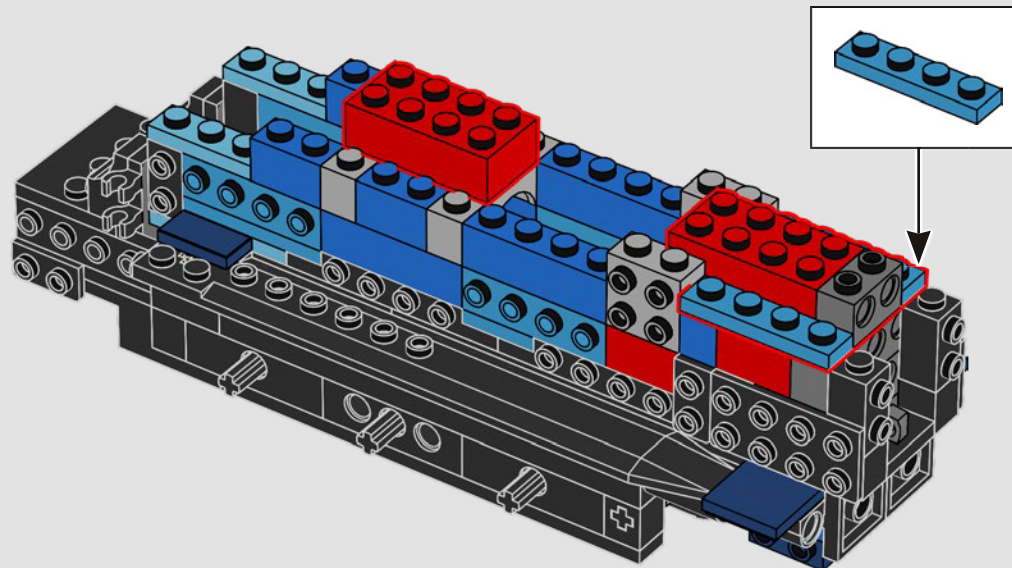

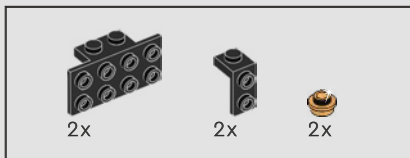

379

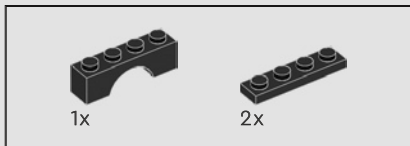
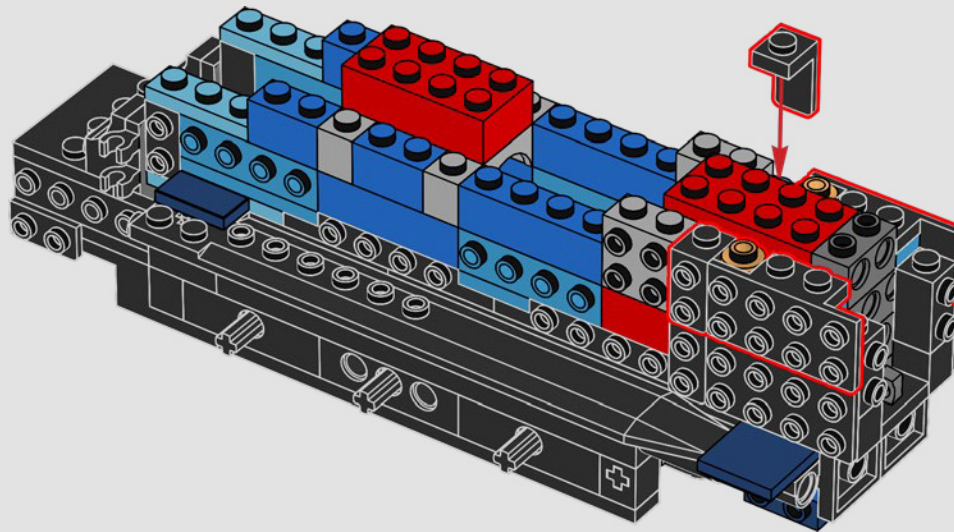

380

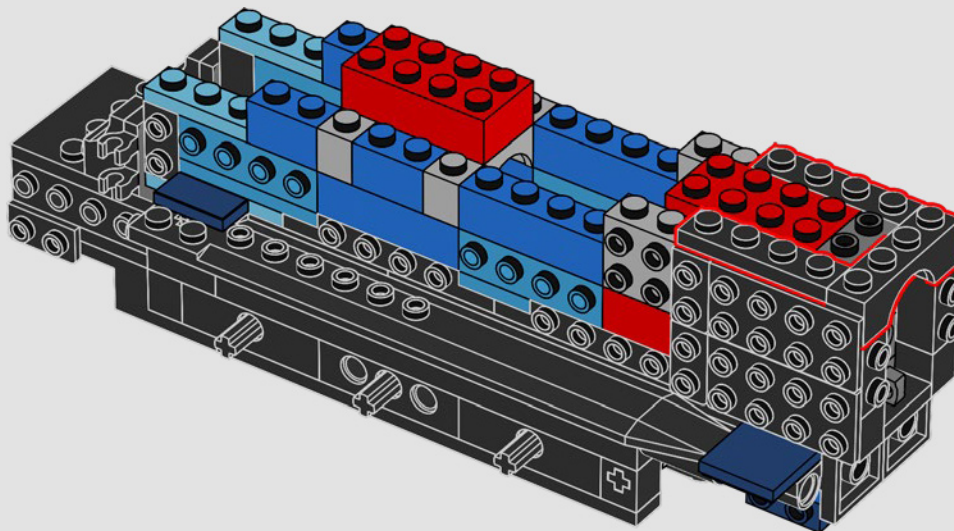

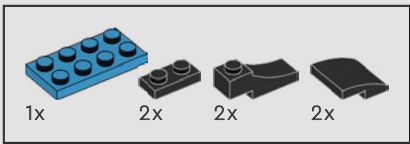

381

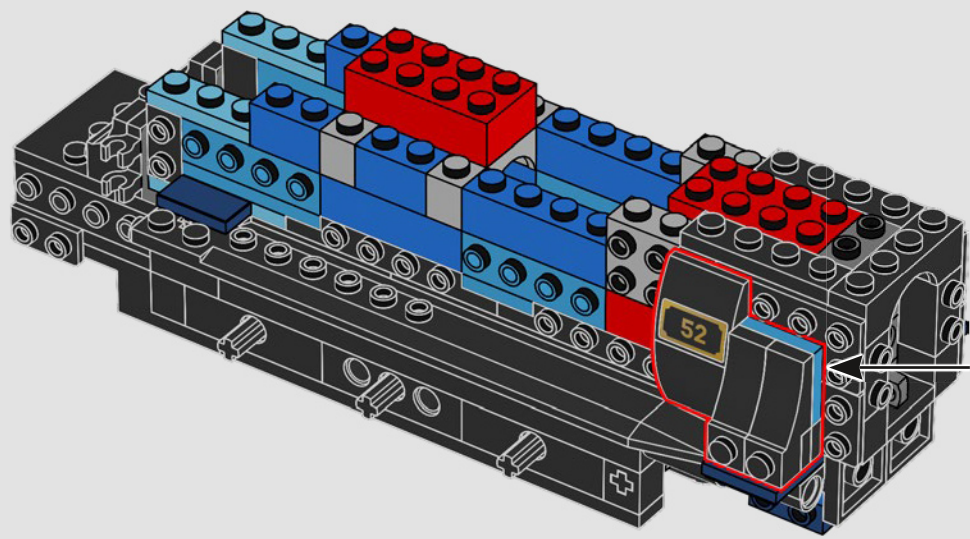
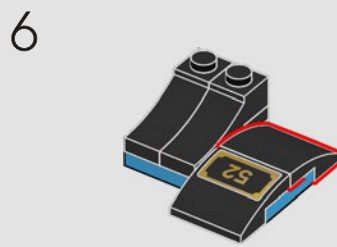
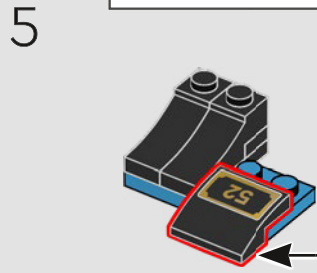
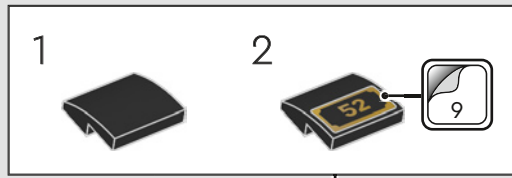
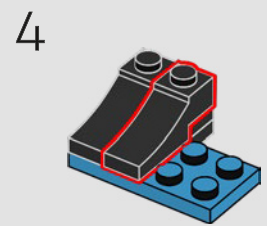
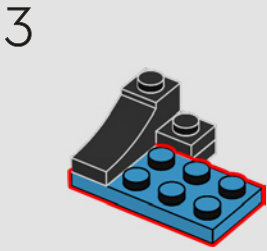
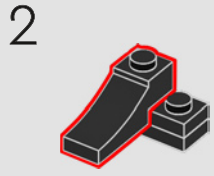
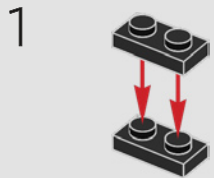

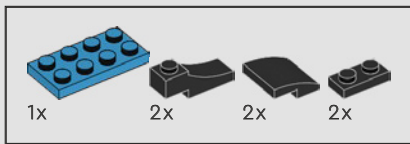

382

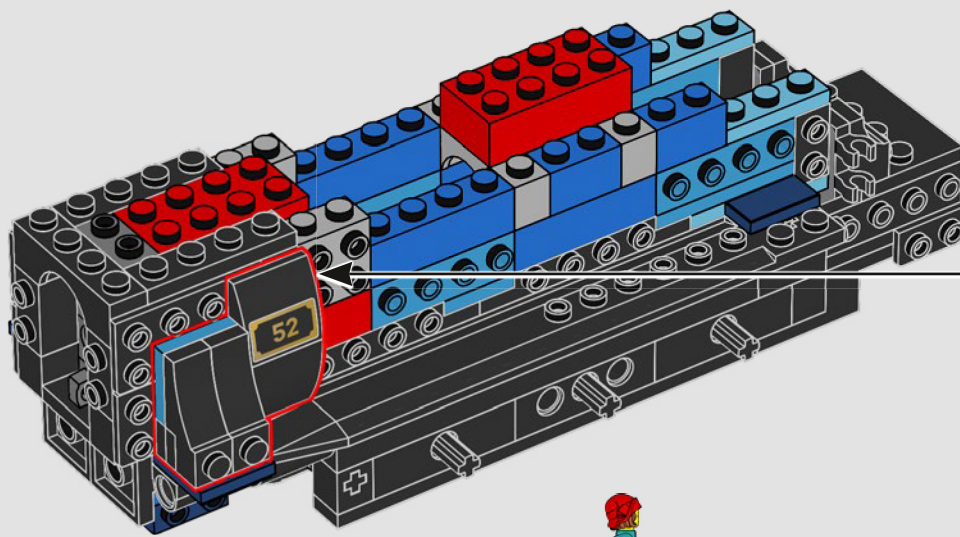
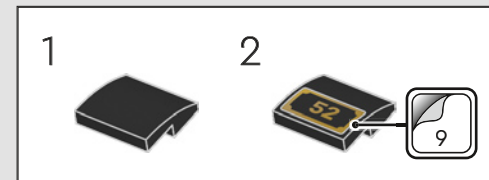
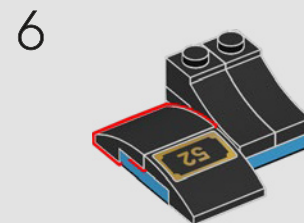
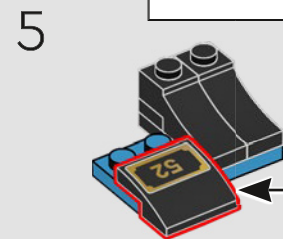
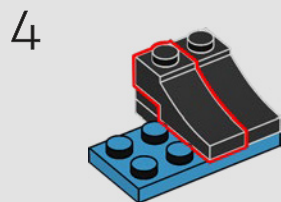
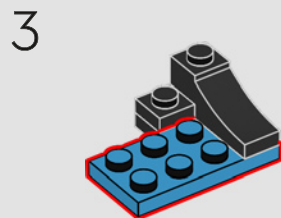
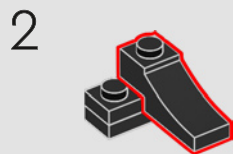
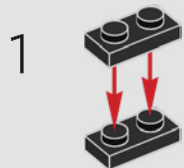

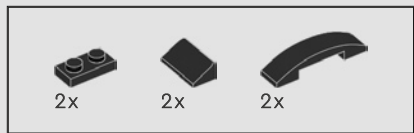

383

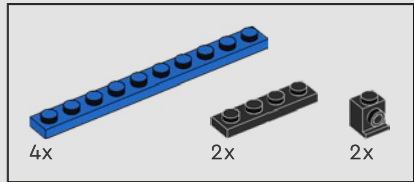
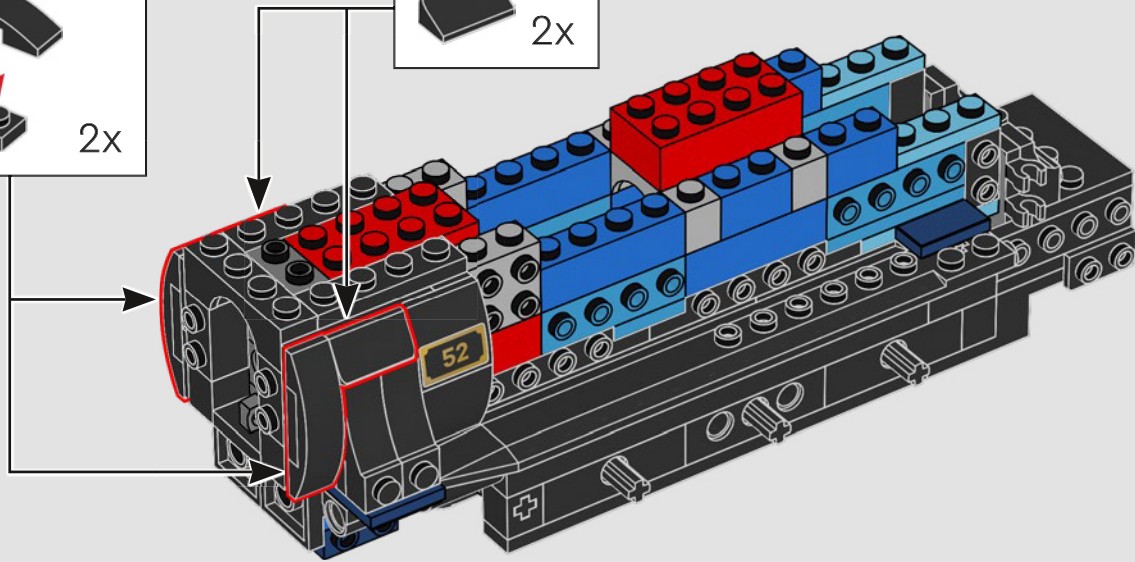
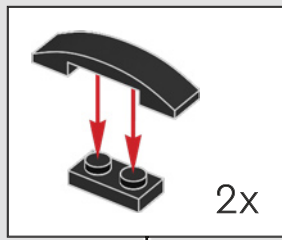

384

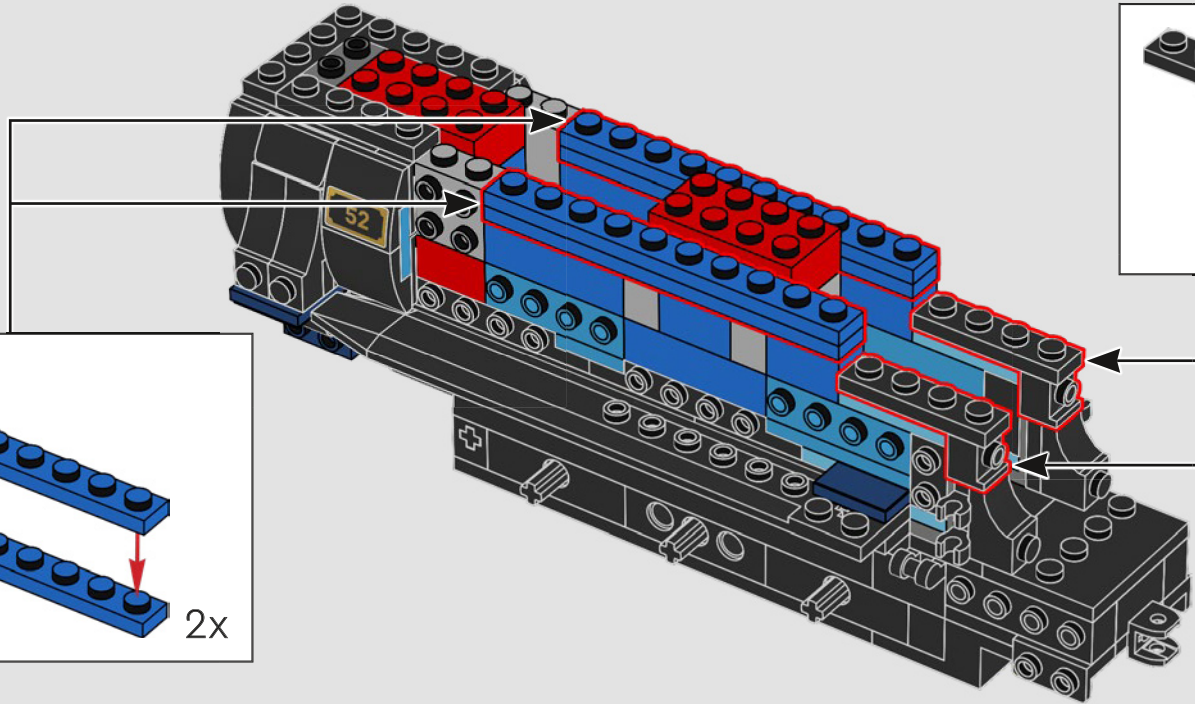
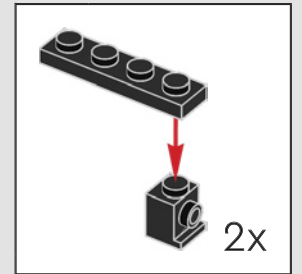
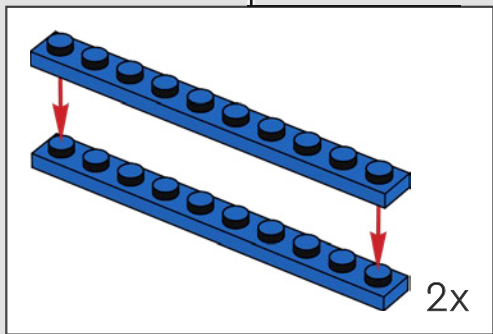

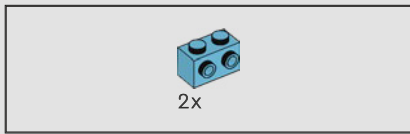

385

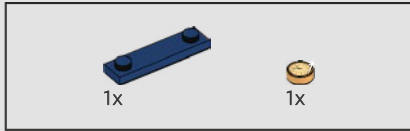
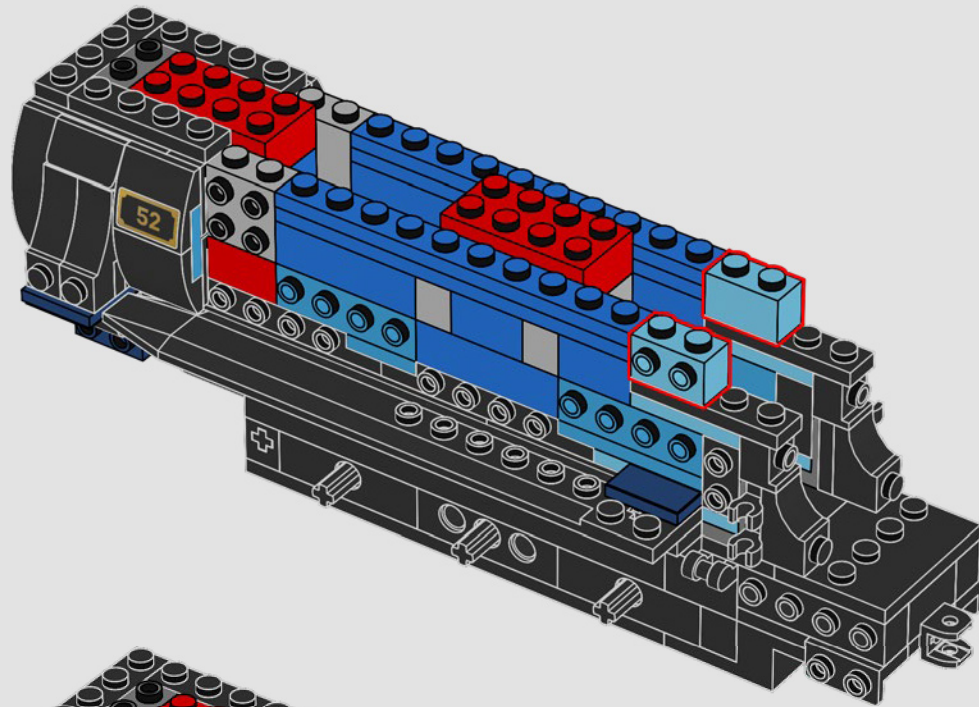

386

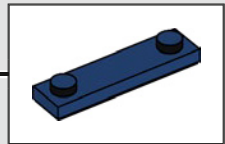
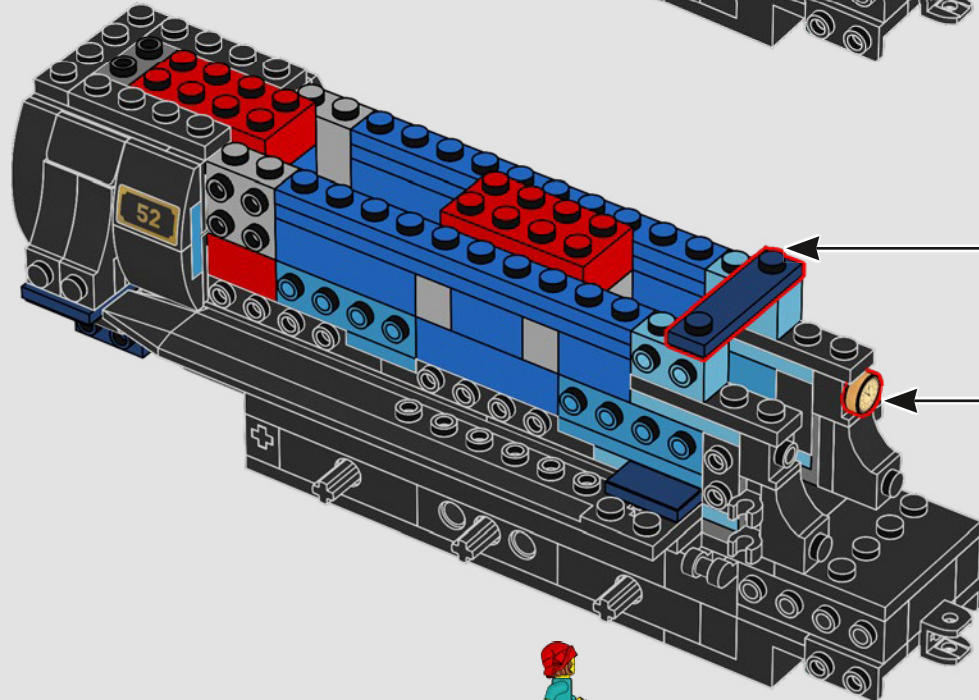

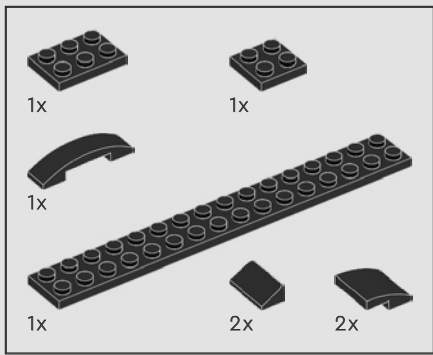

387

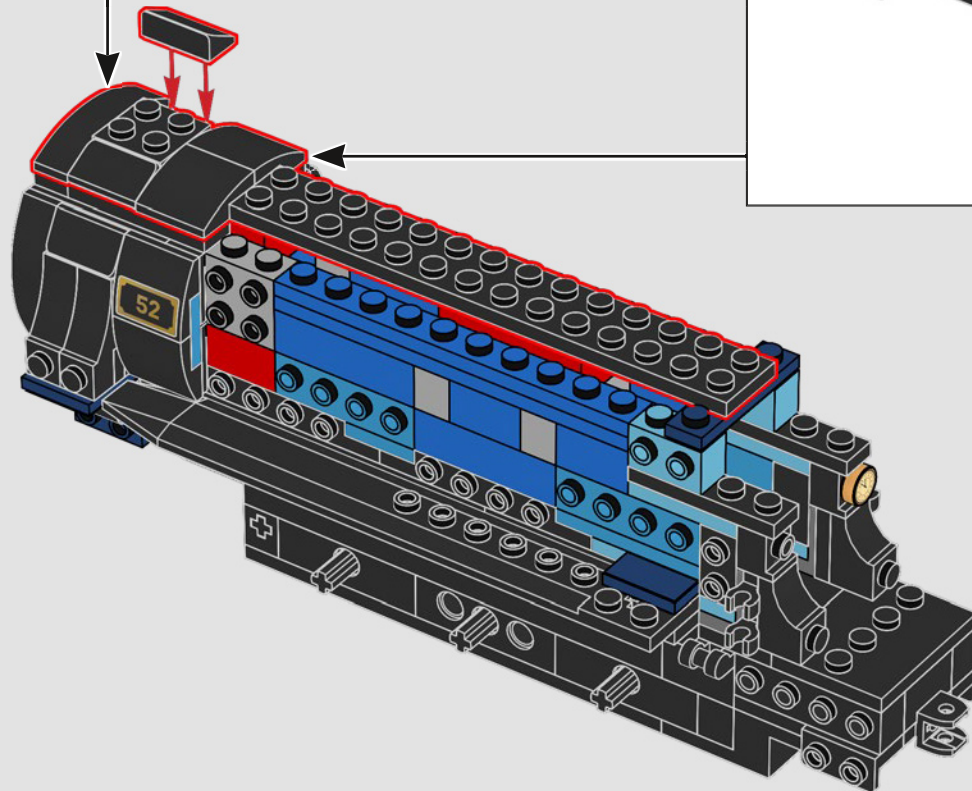
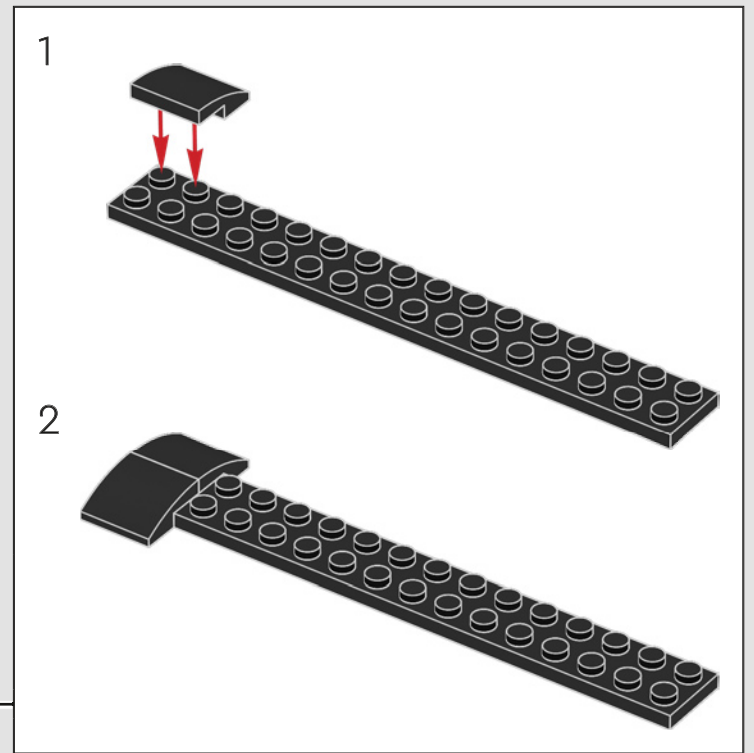
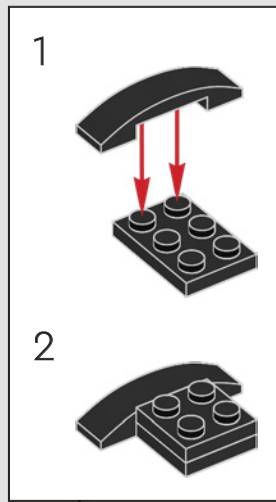

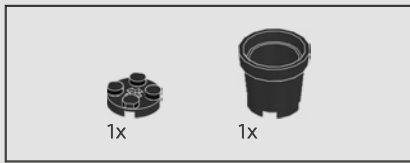

388

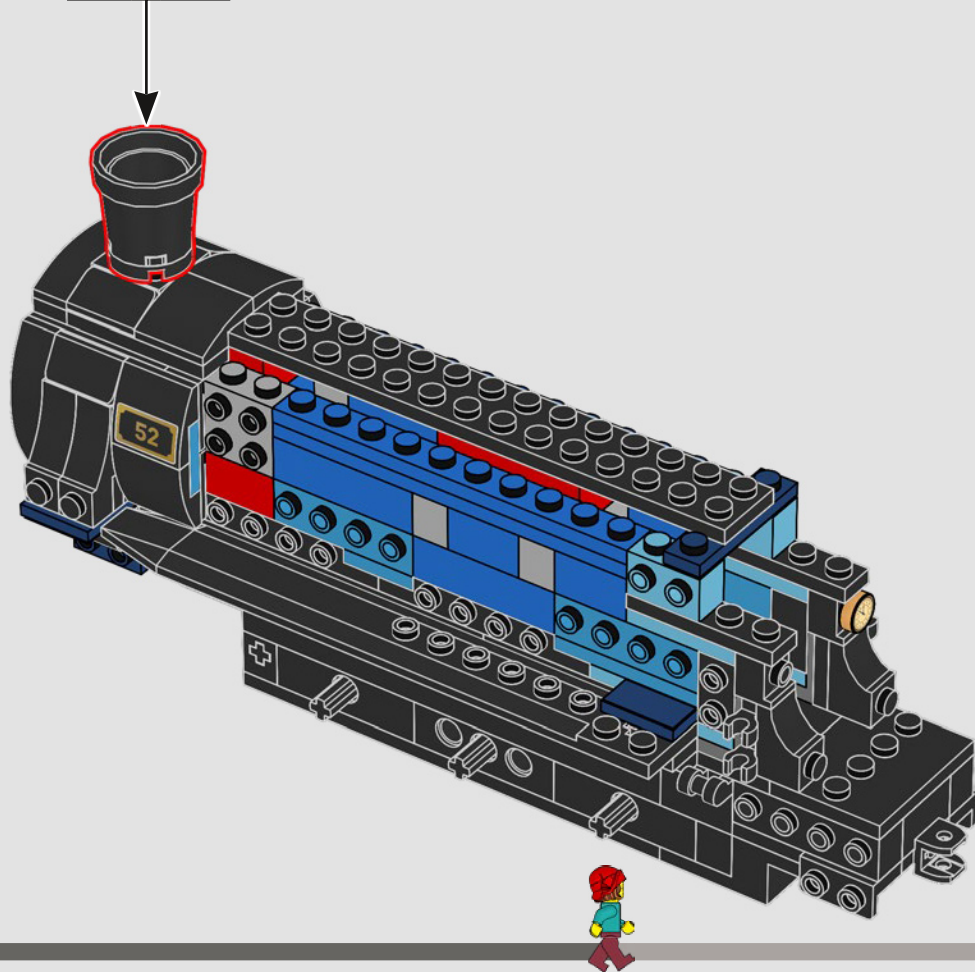
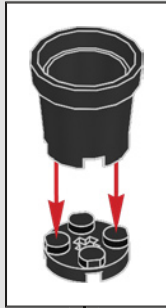

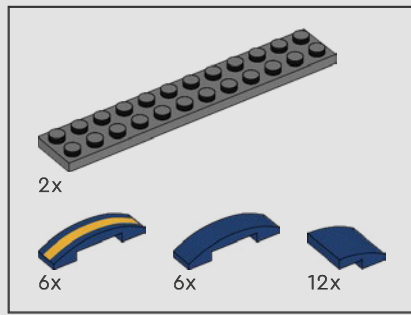

389

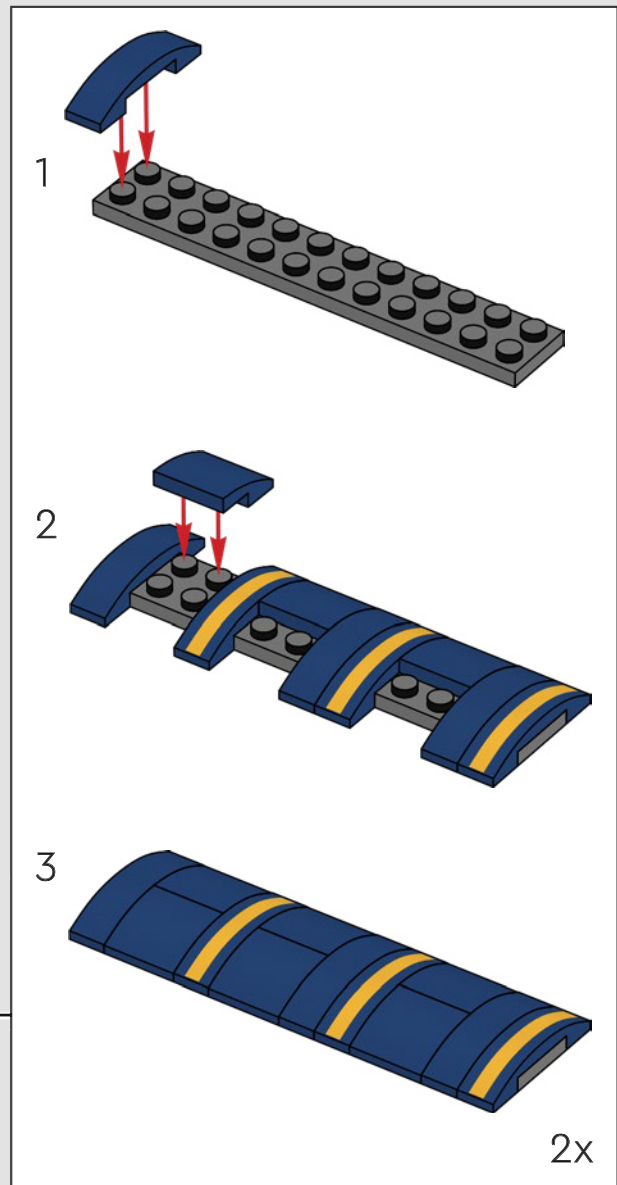
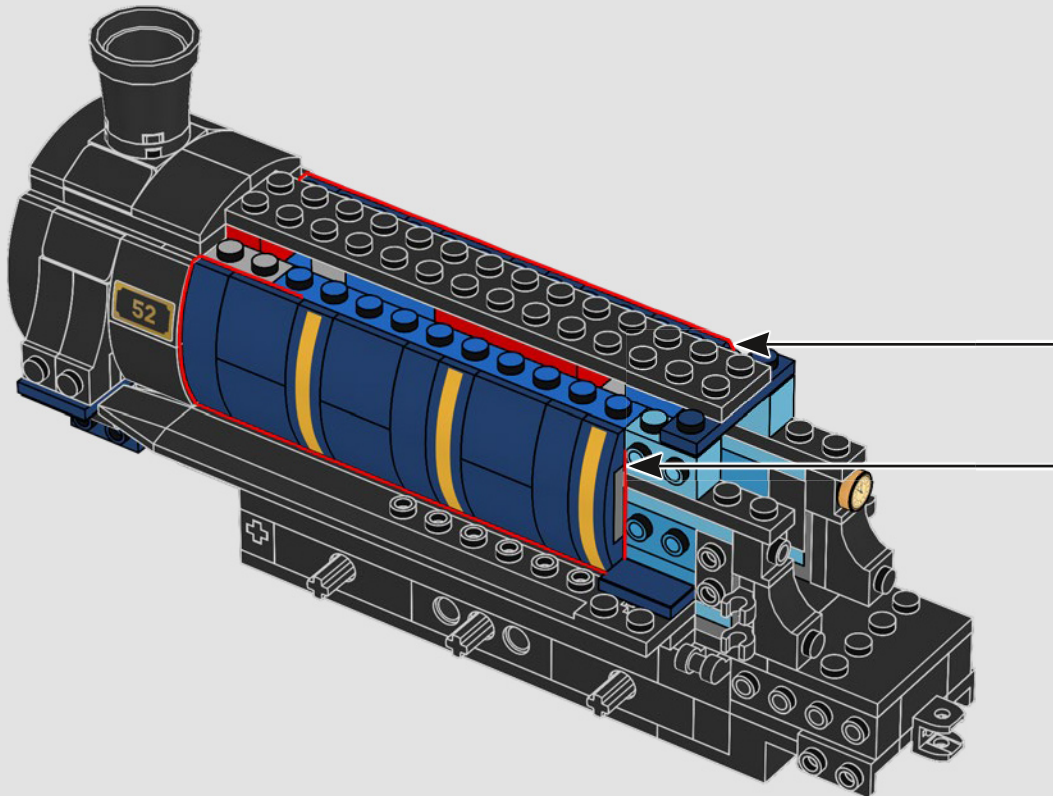

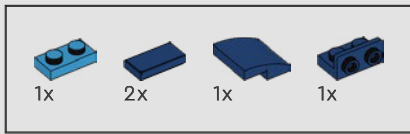

390

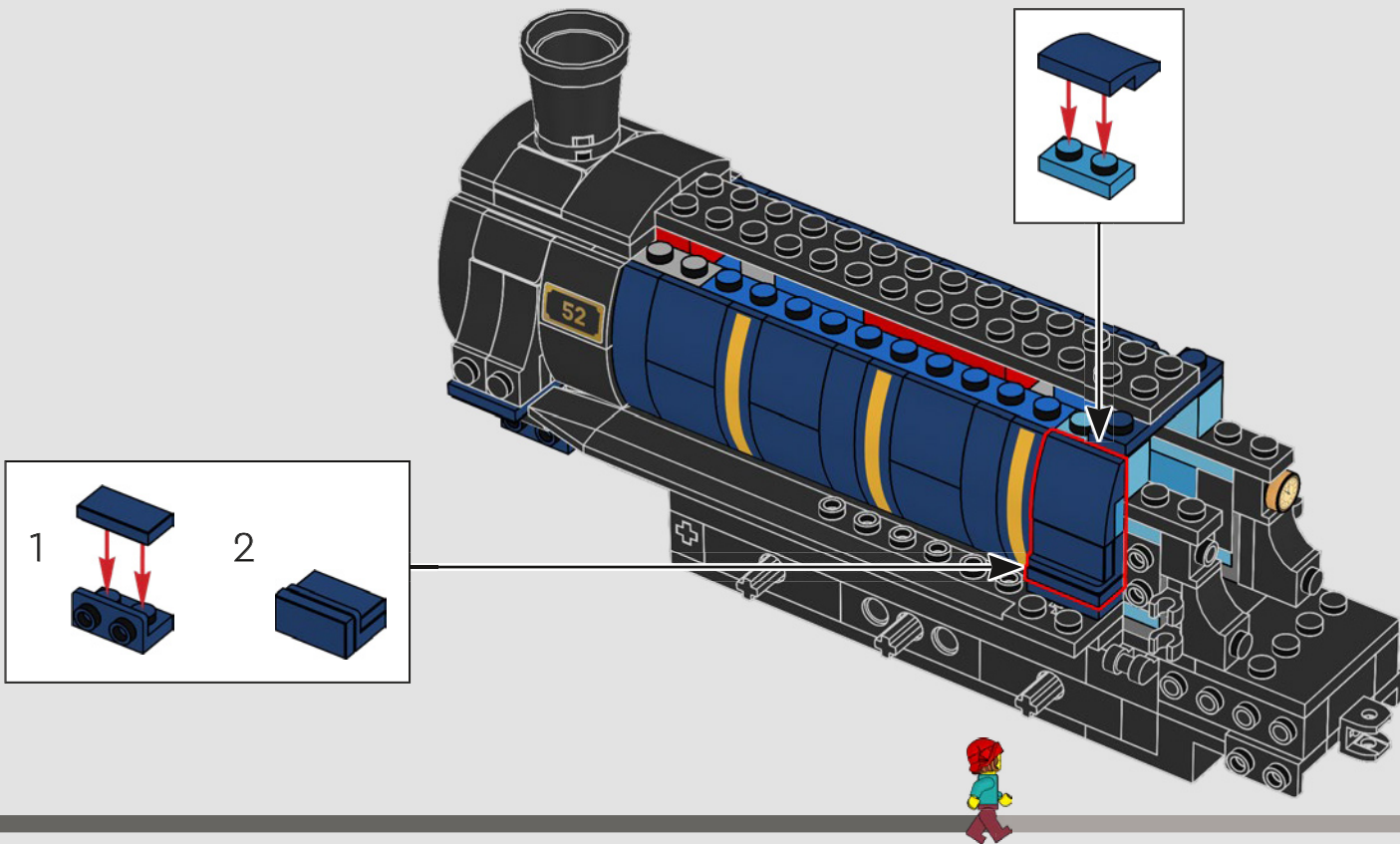

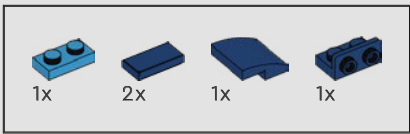

391

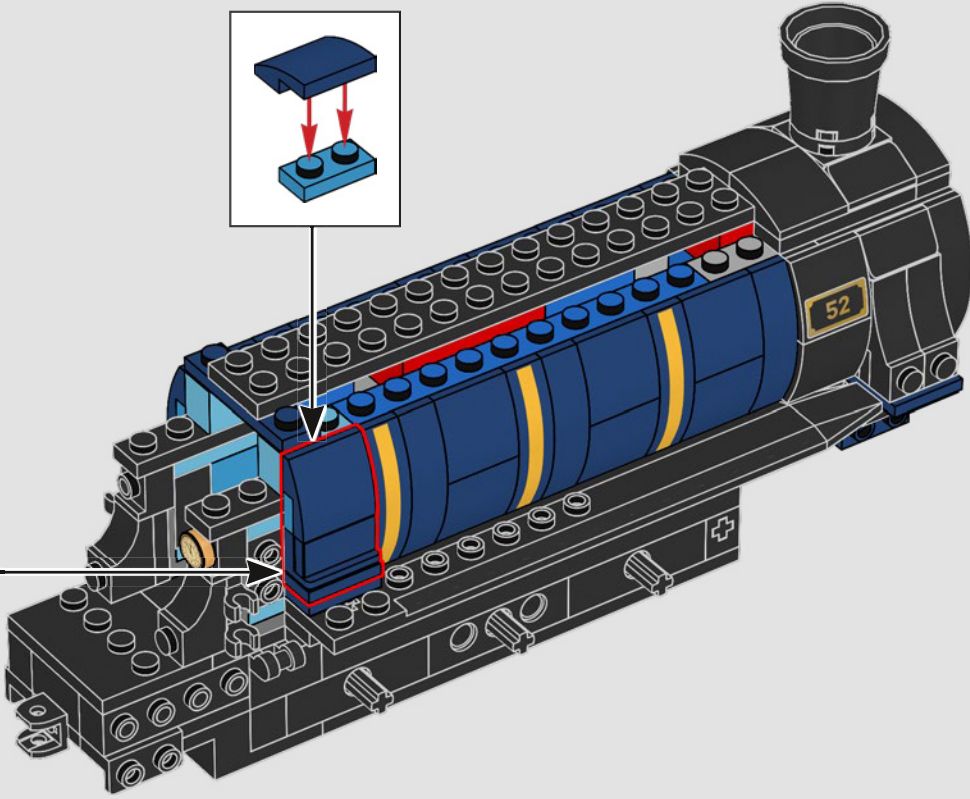
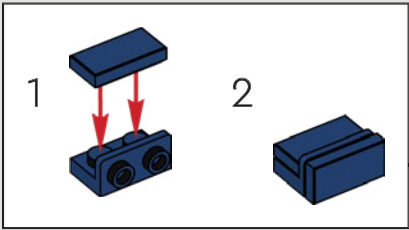
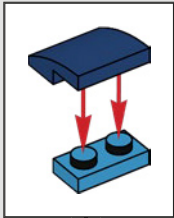

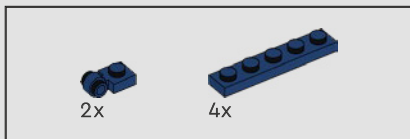

392

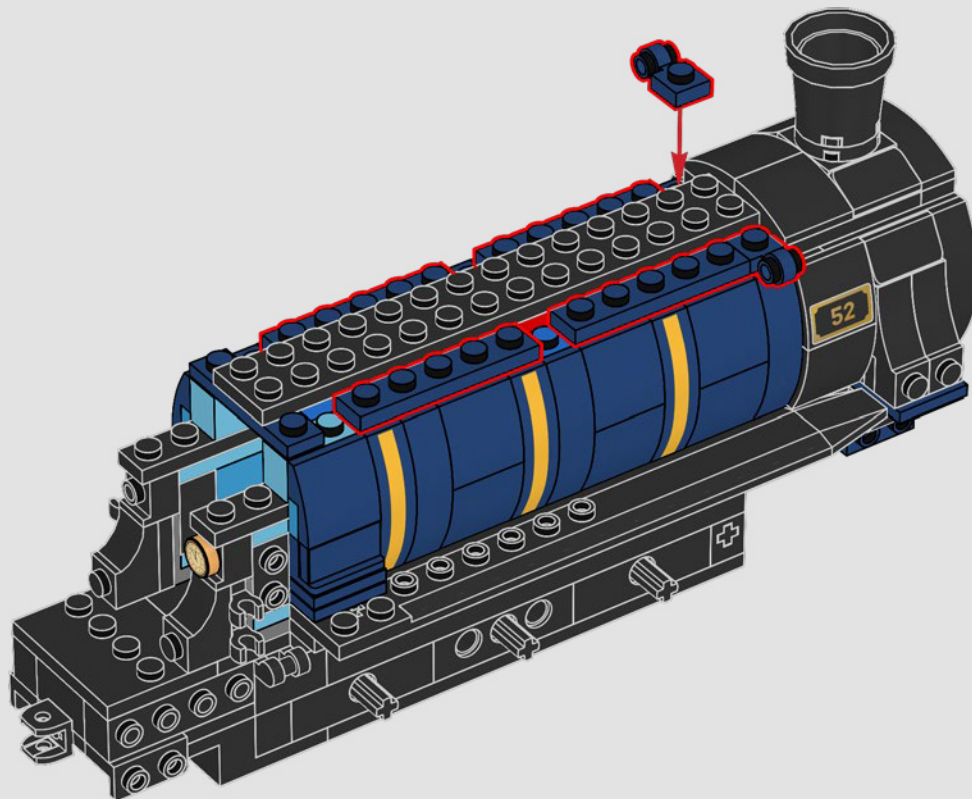



393

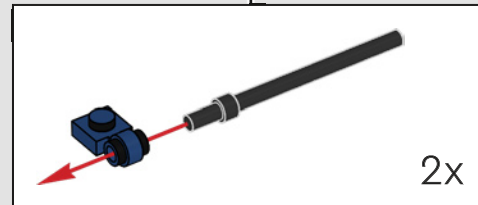
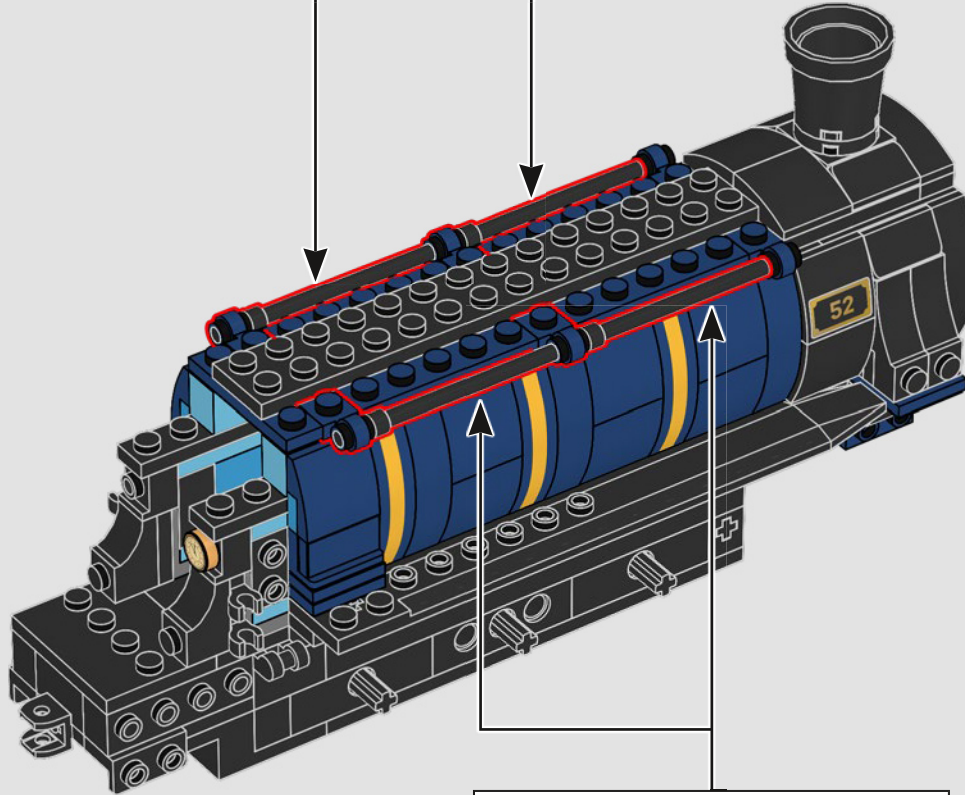
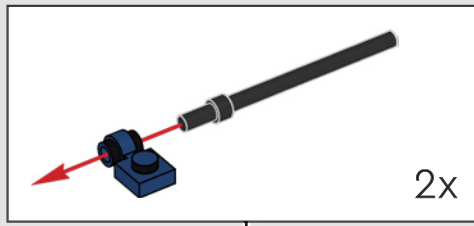

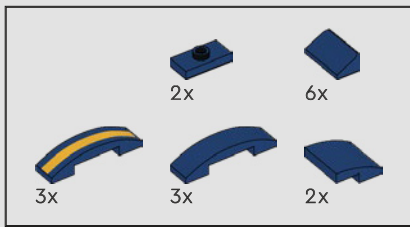

394

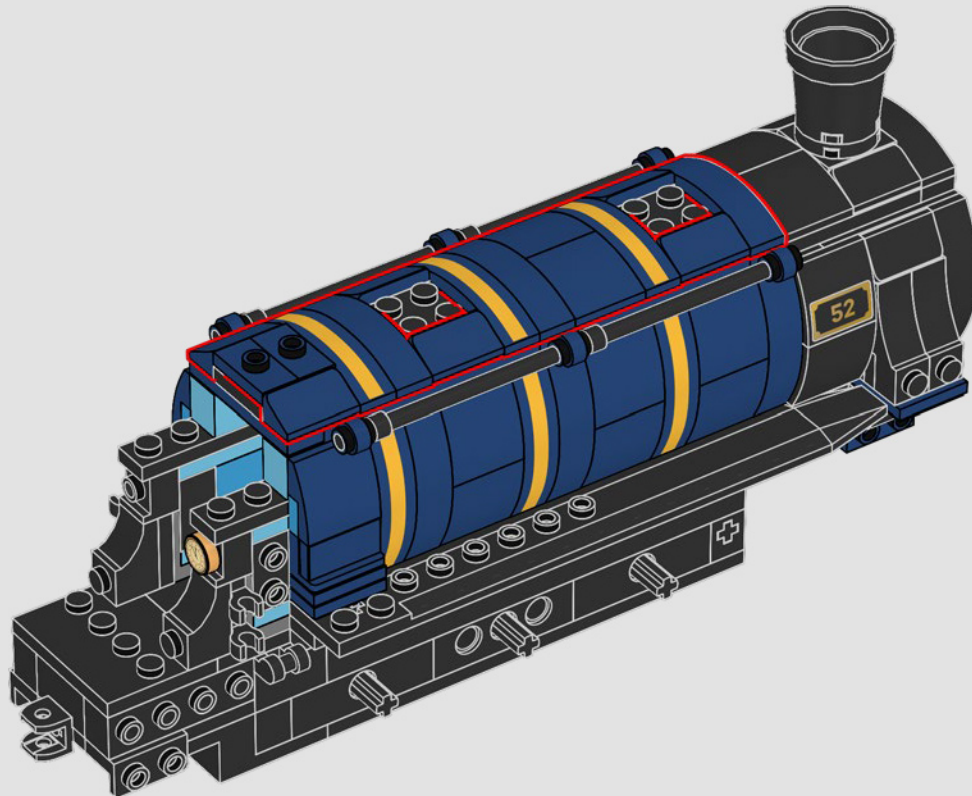

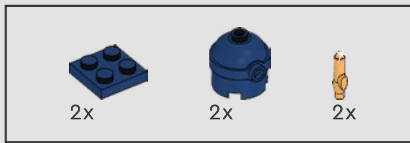

396

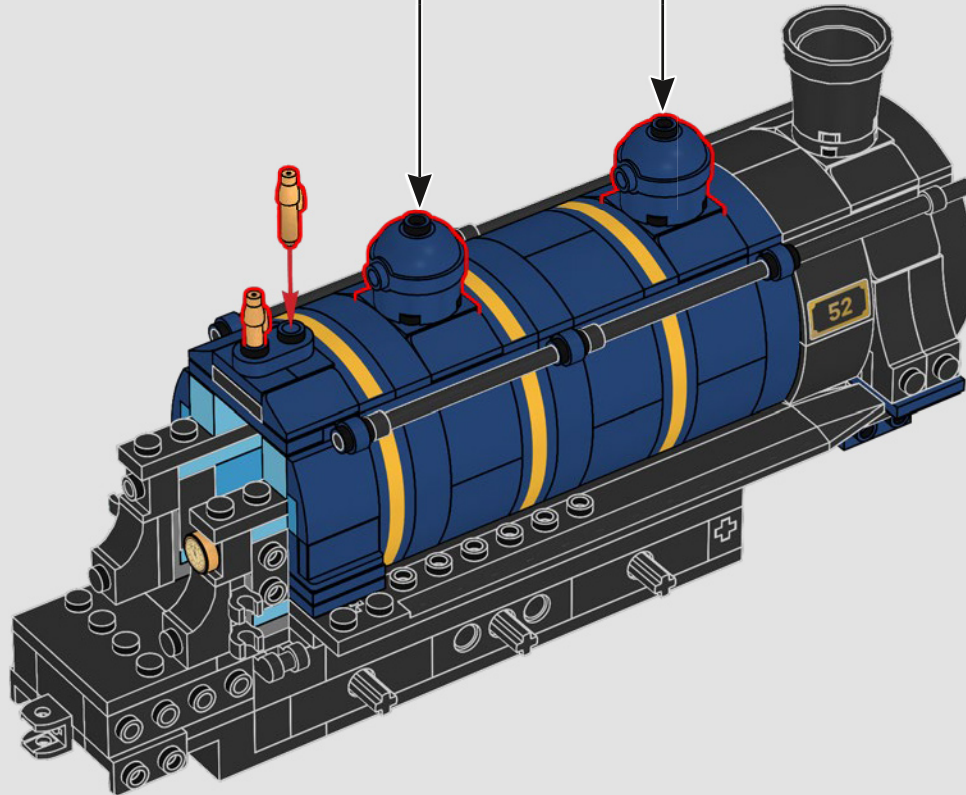
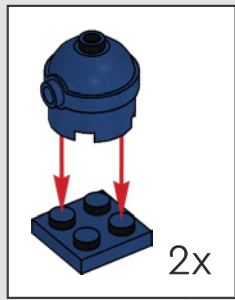

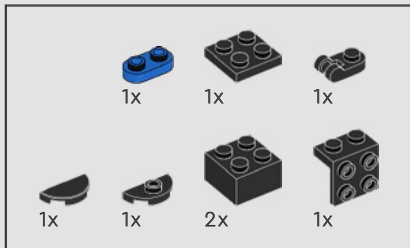
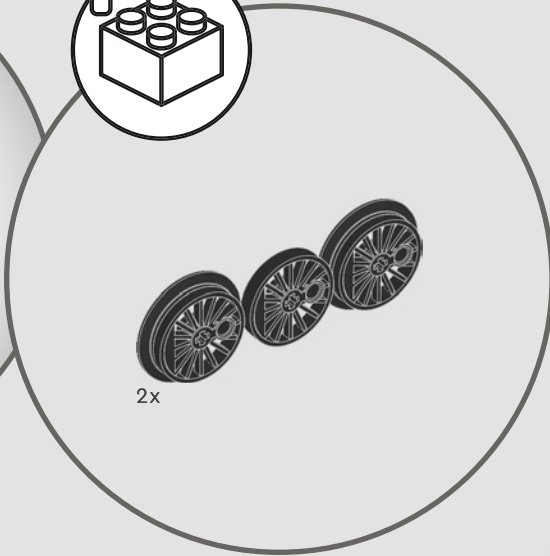
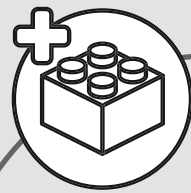

397

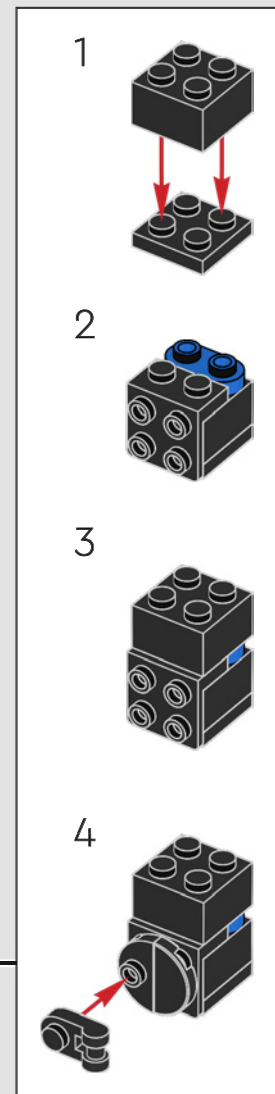
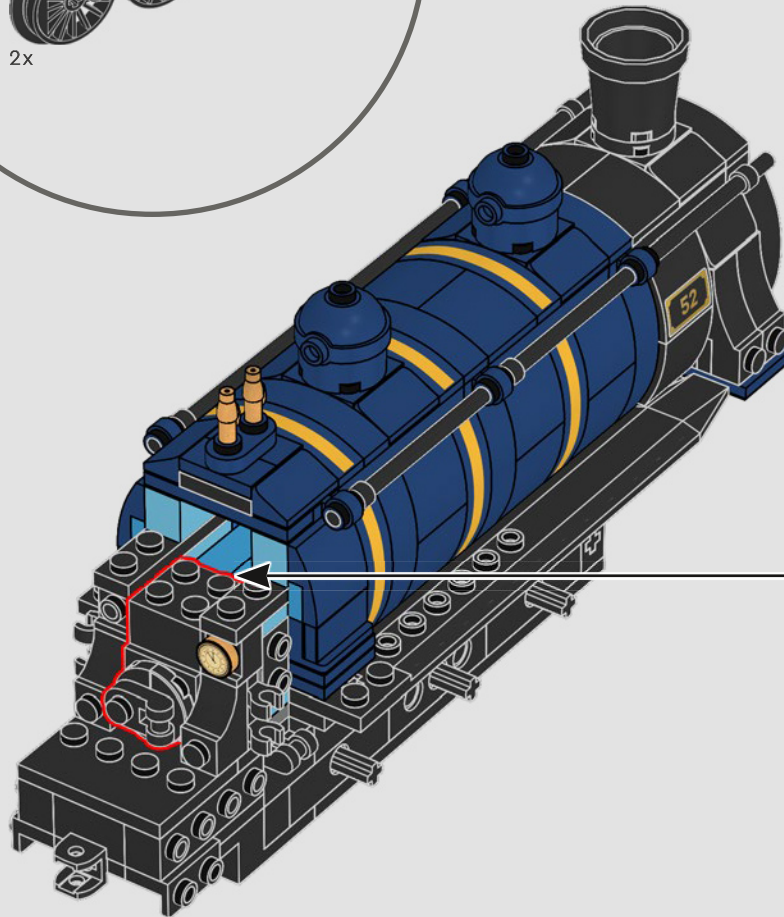

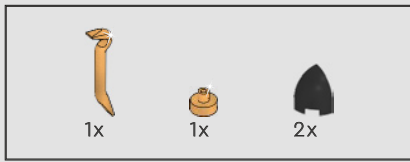

398

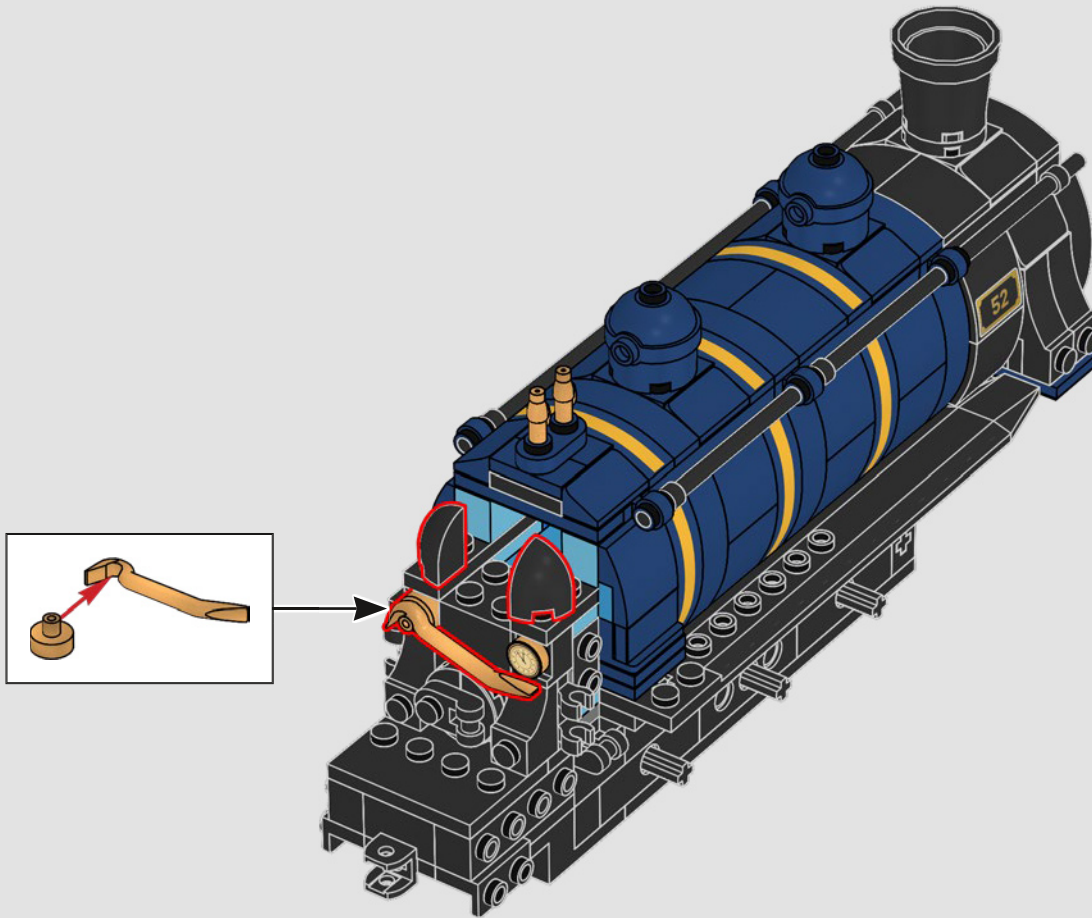

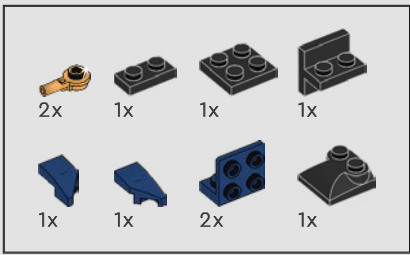

399

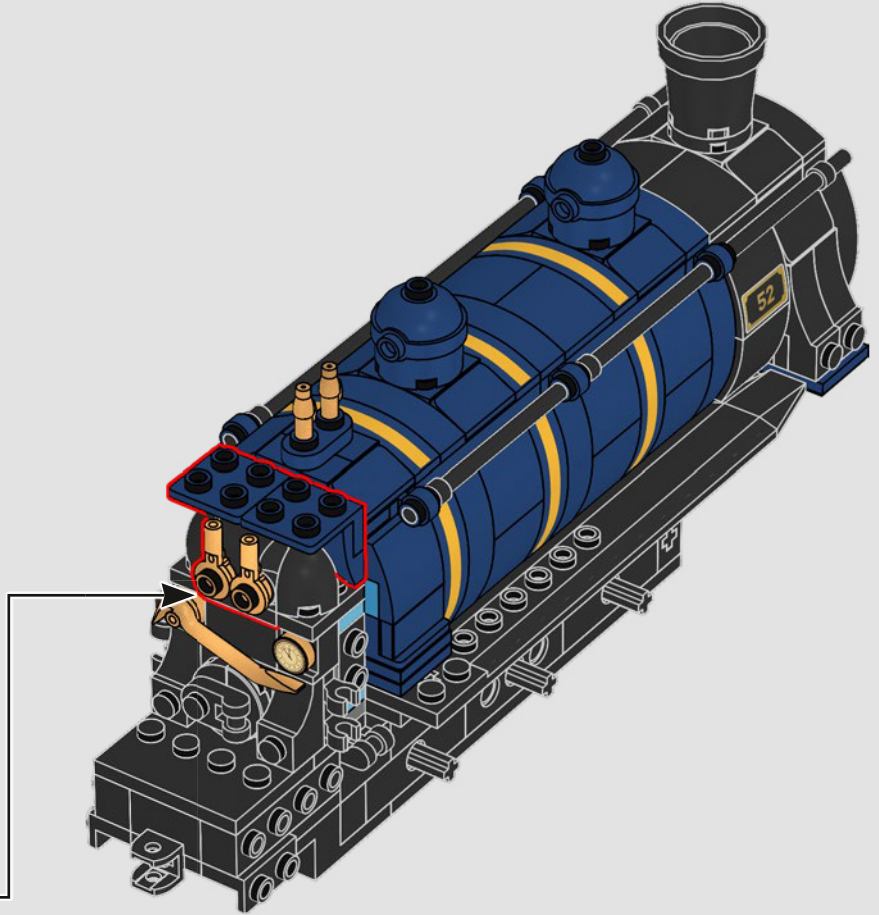
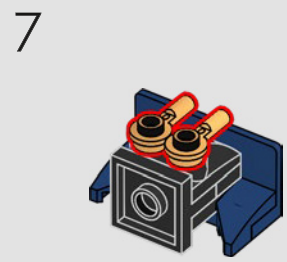
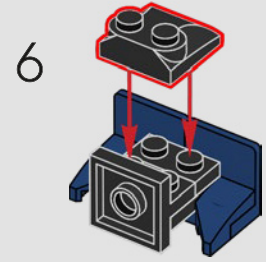
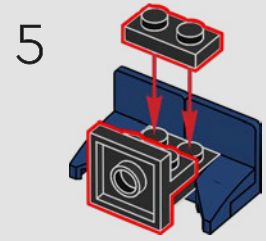
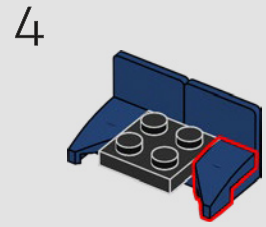
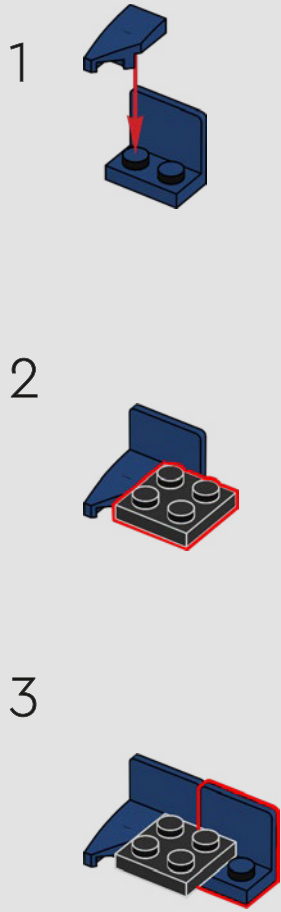

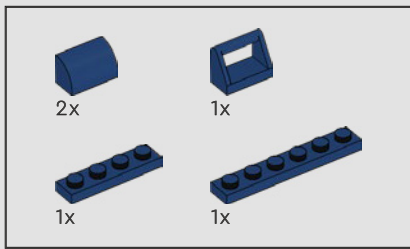

400

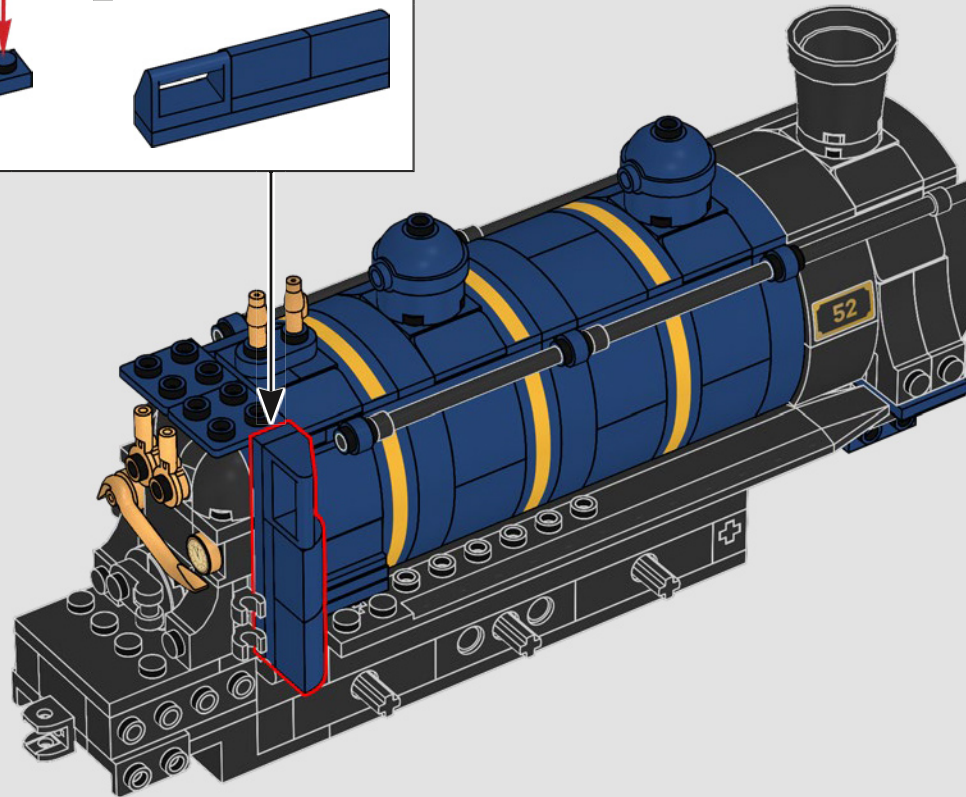
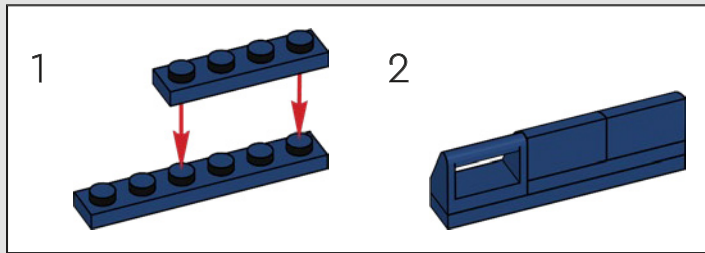

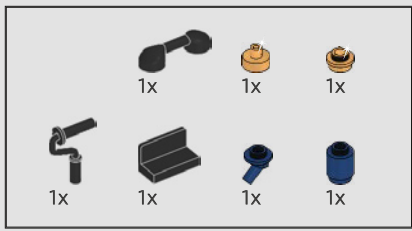

401

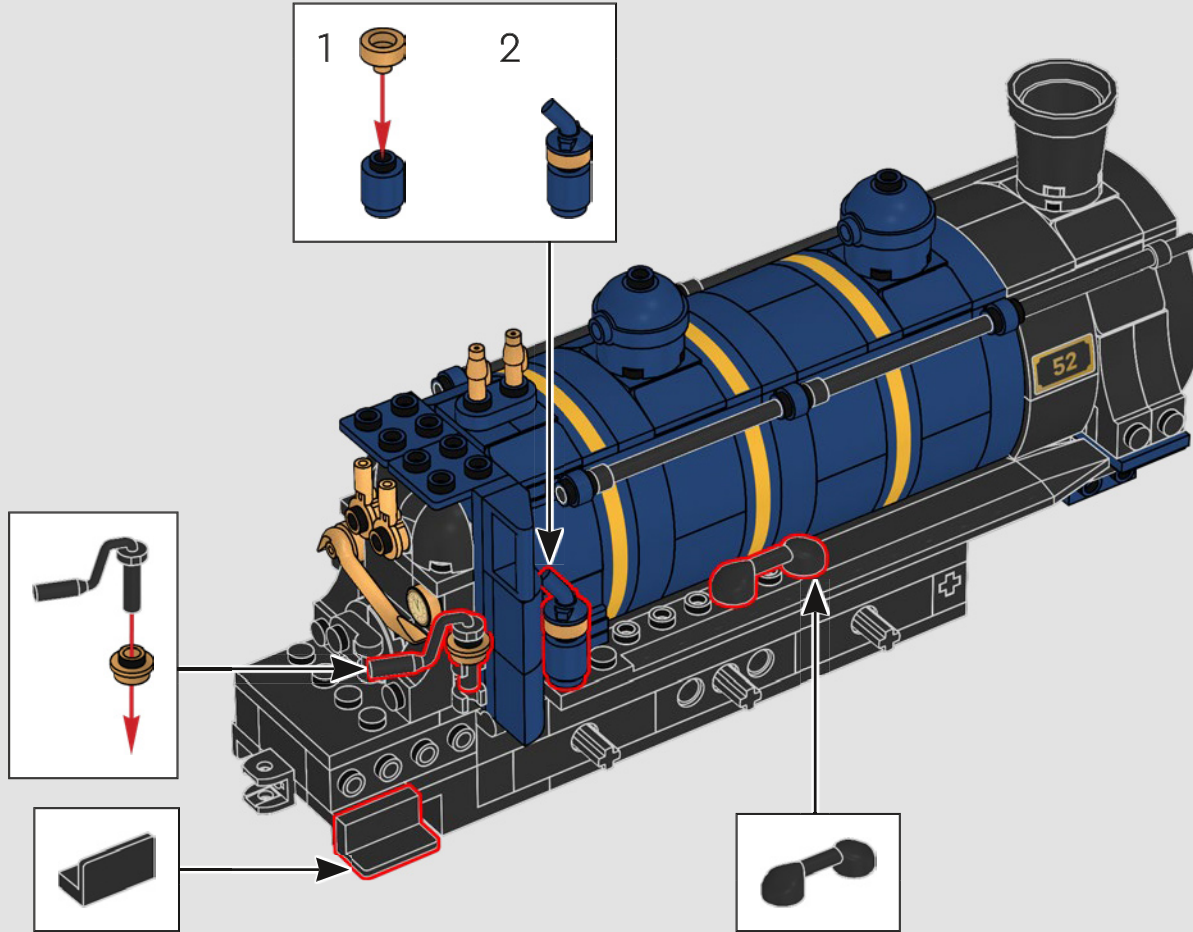

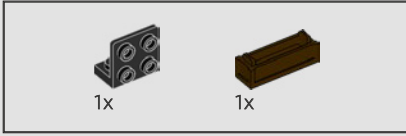
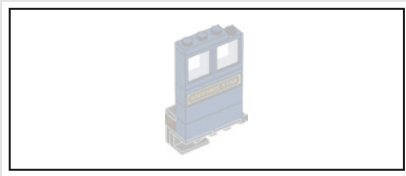

402

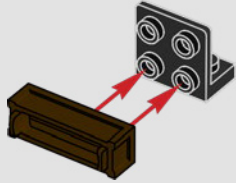

403

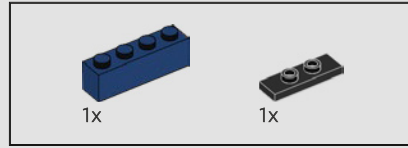
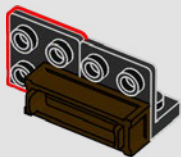

404

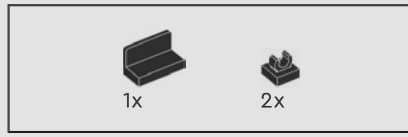
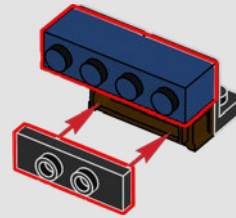

405

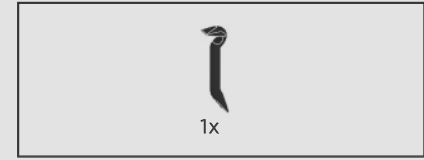
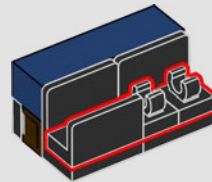

406

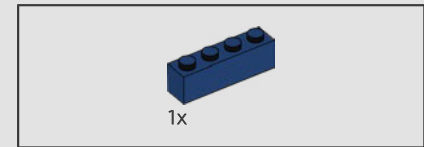
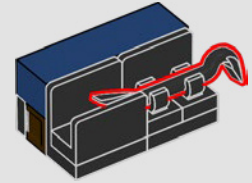

407

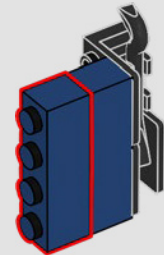
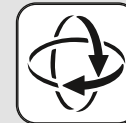

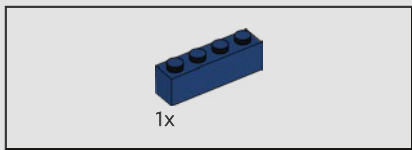

408

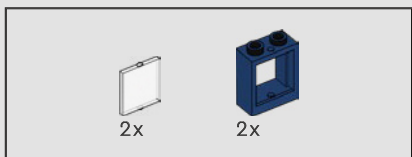
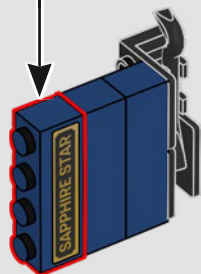
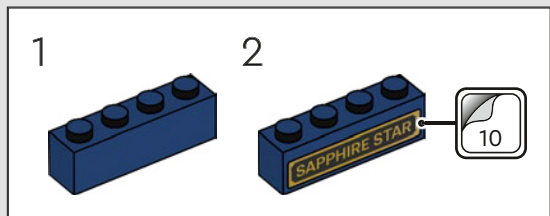

409

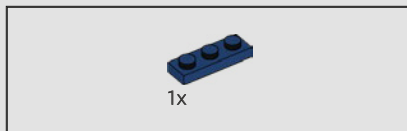
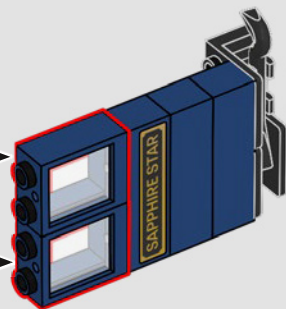
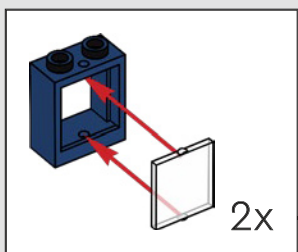

410

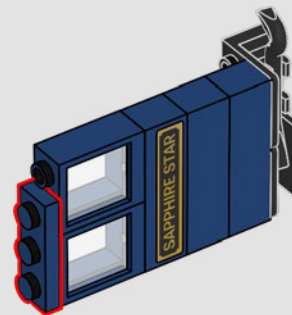

411

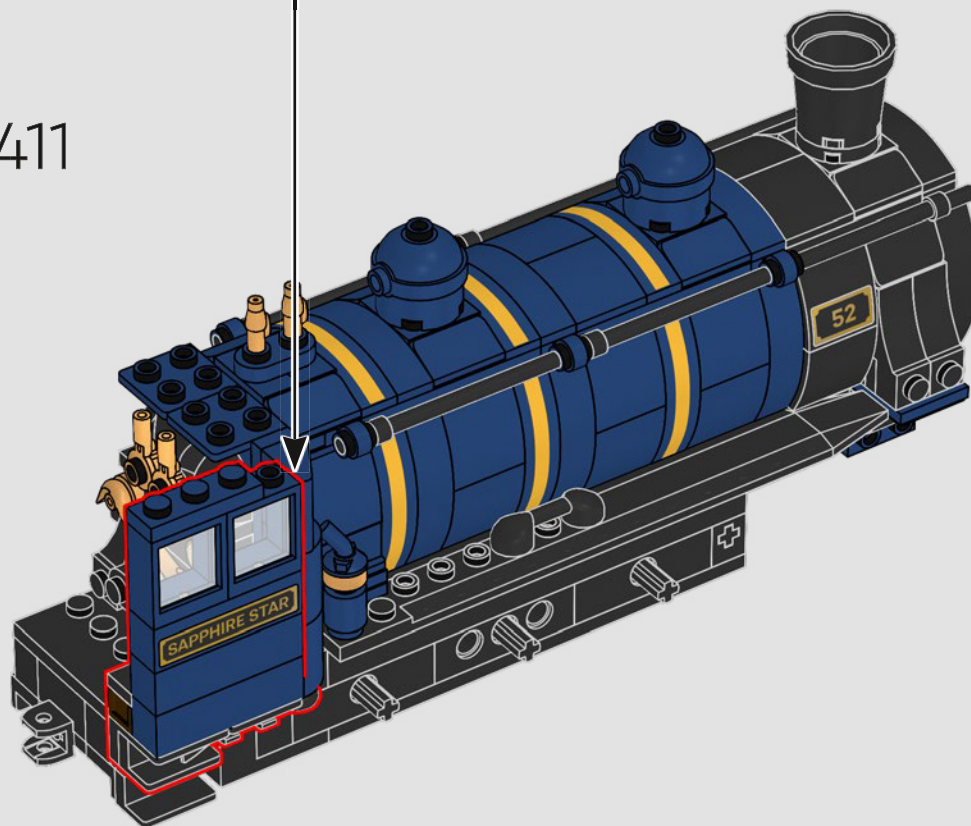

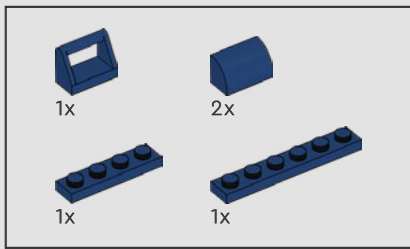

412

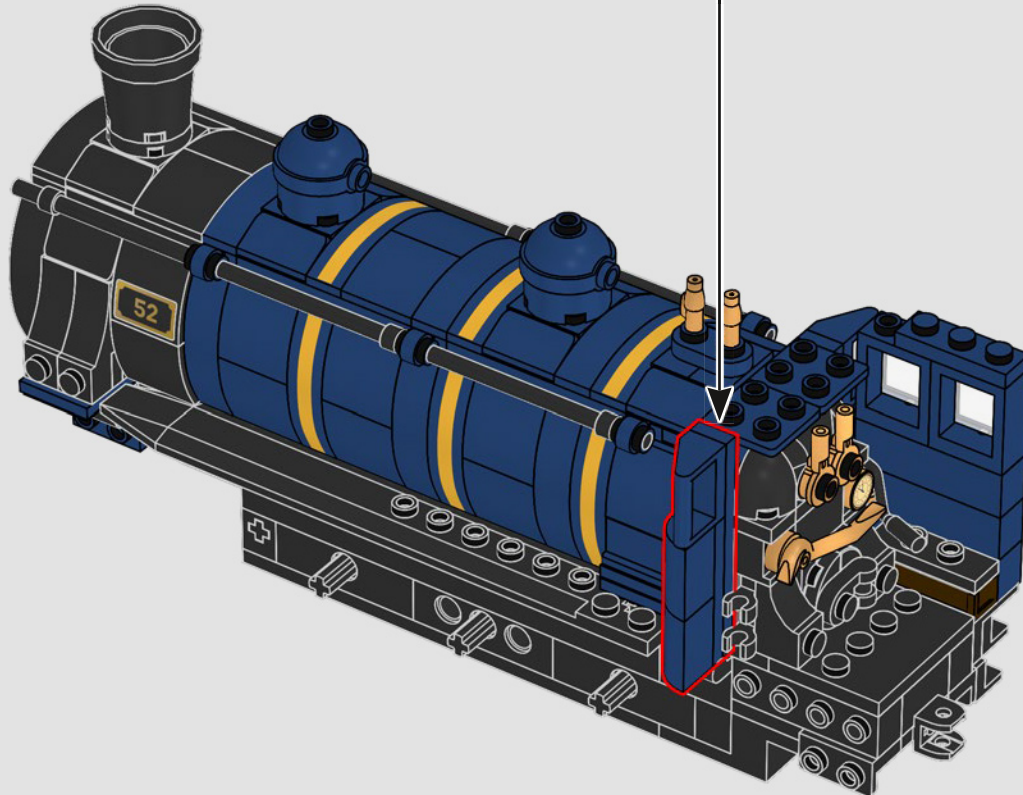
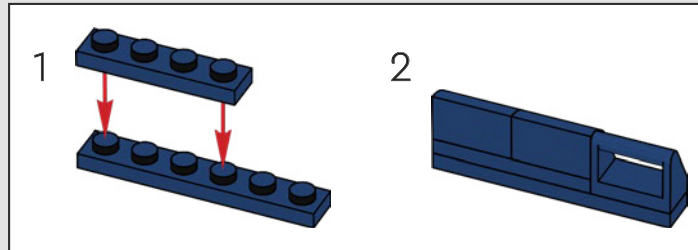

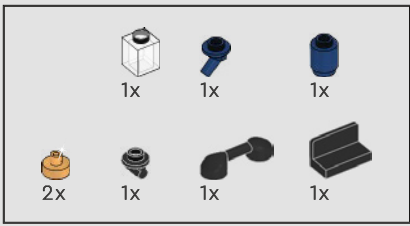

413

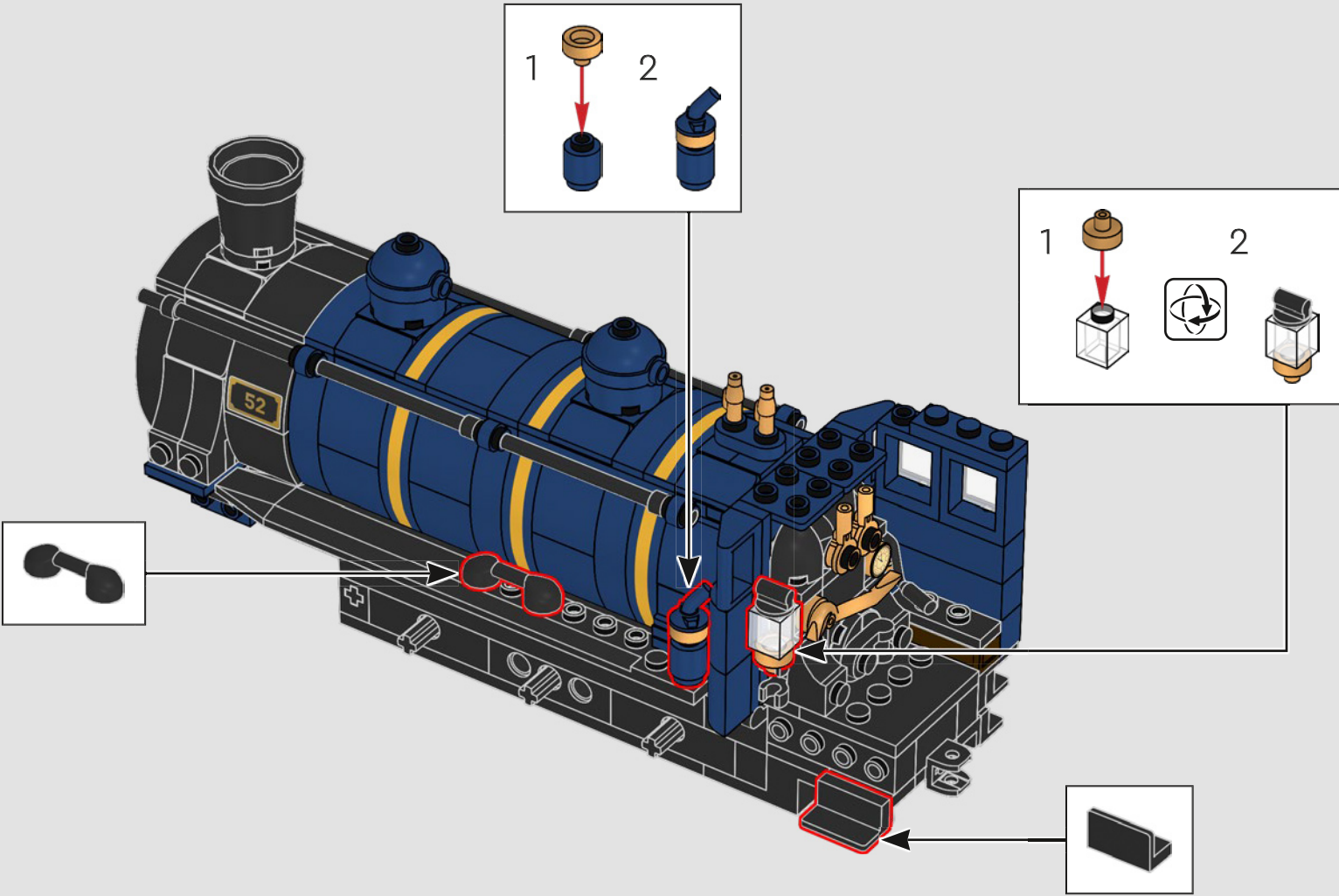

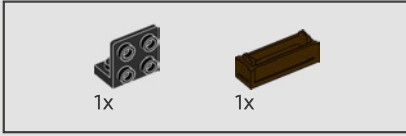
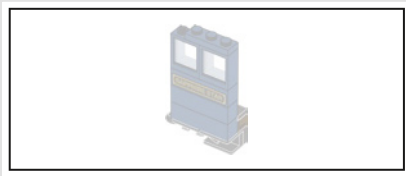

414

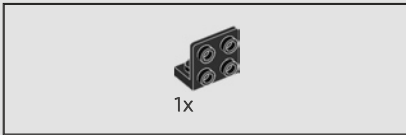
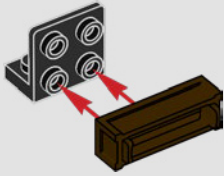

415

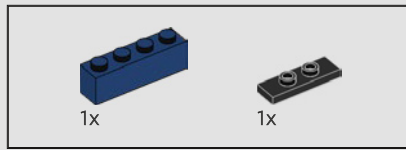
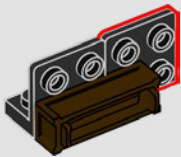

416

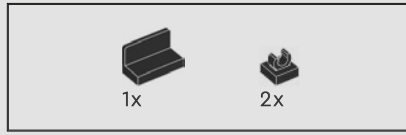
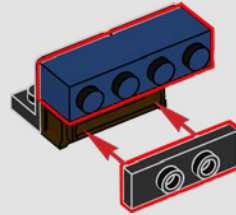

417

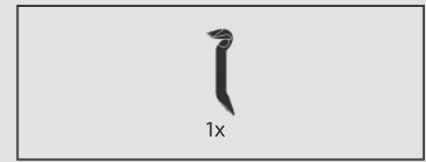
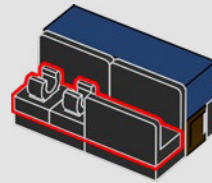

418

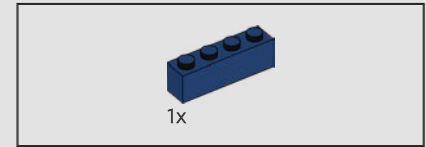
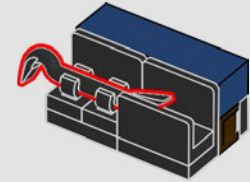

419

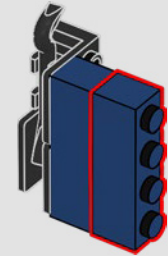

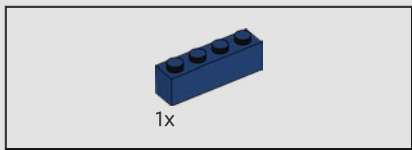

420

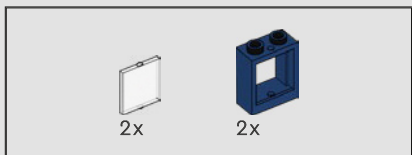
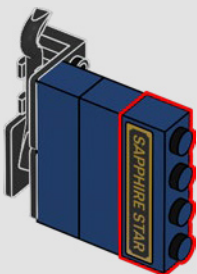
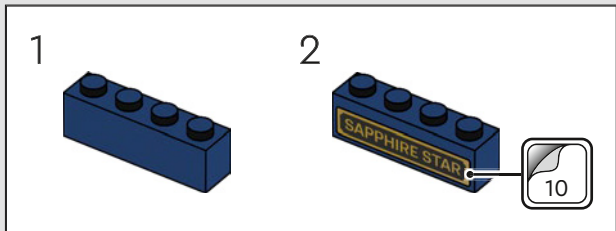

421

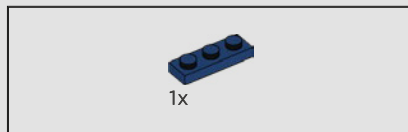
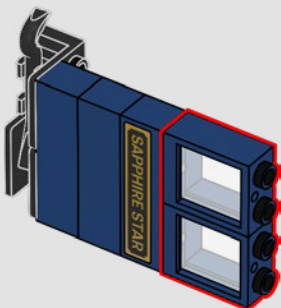
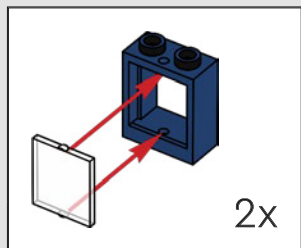

422

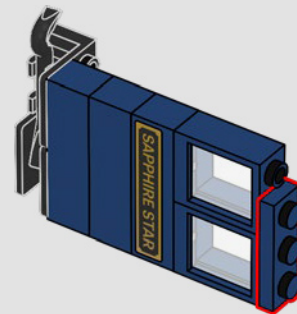

423

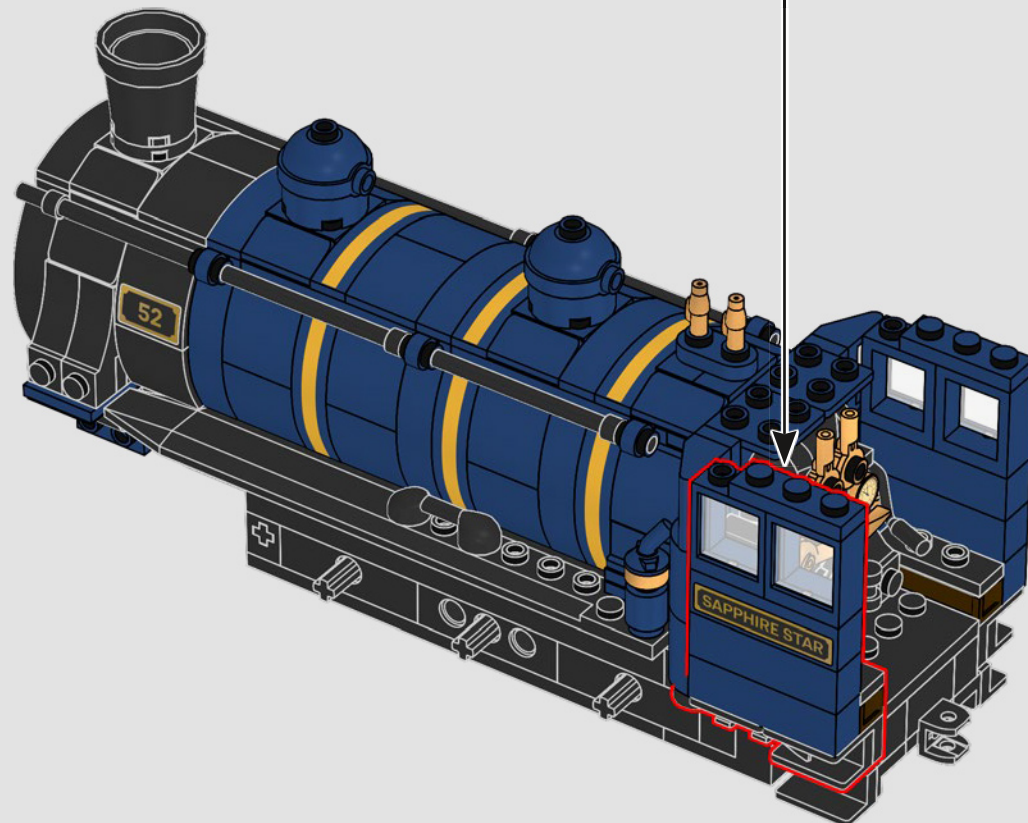

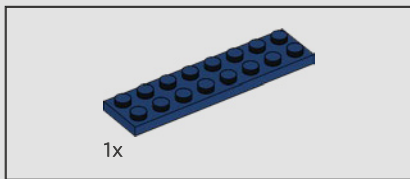

424

“星光蓝宝石——这是多么珍贵的宝石啊！
我想起了多年前我在爱尔兰 (Emerald Isle)
乘坐的夜班火车。”

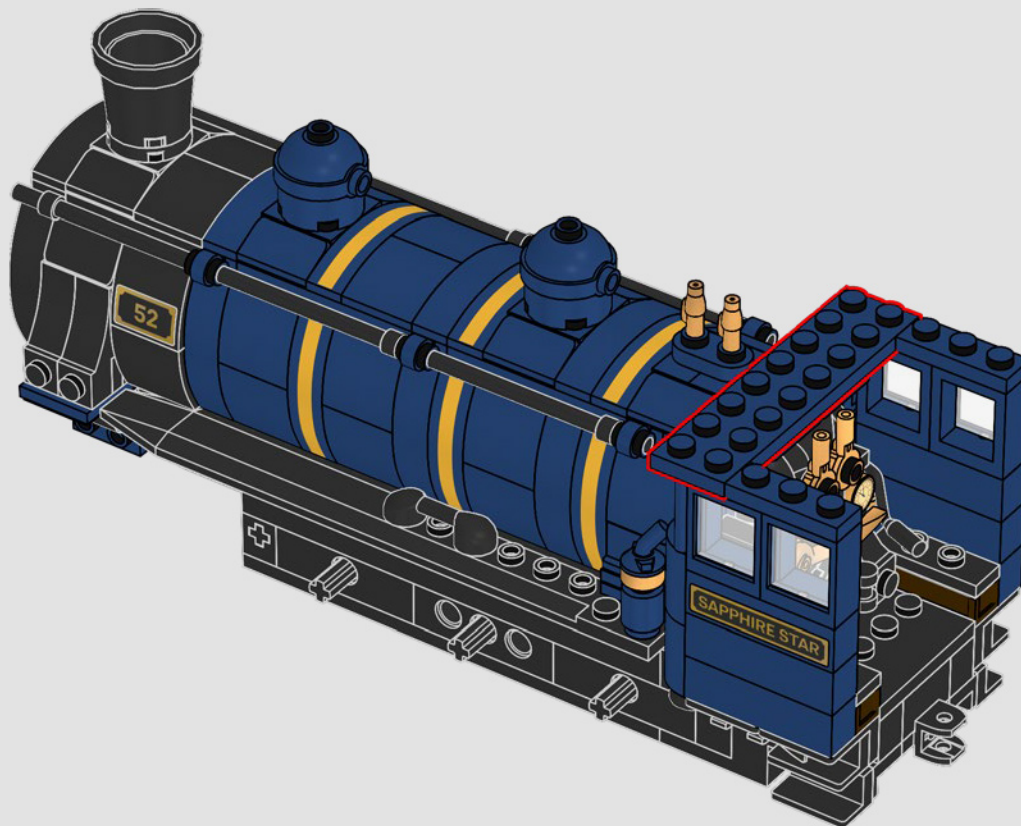

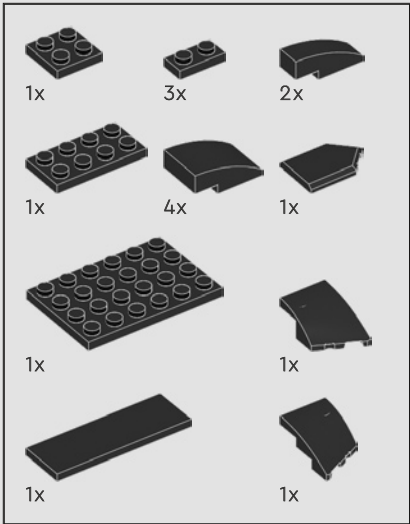

425

1

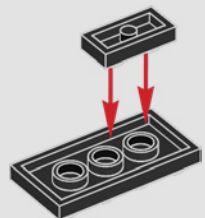

2

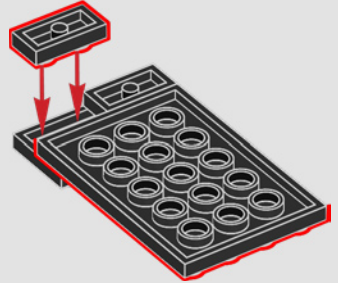

3

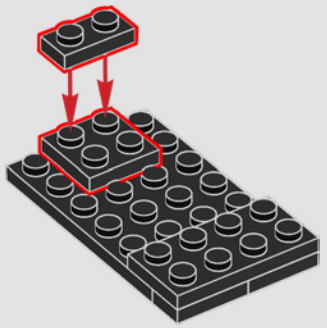
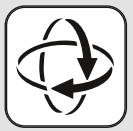

4

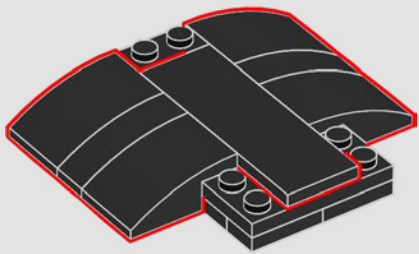

5

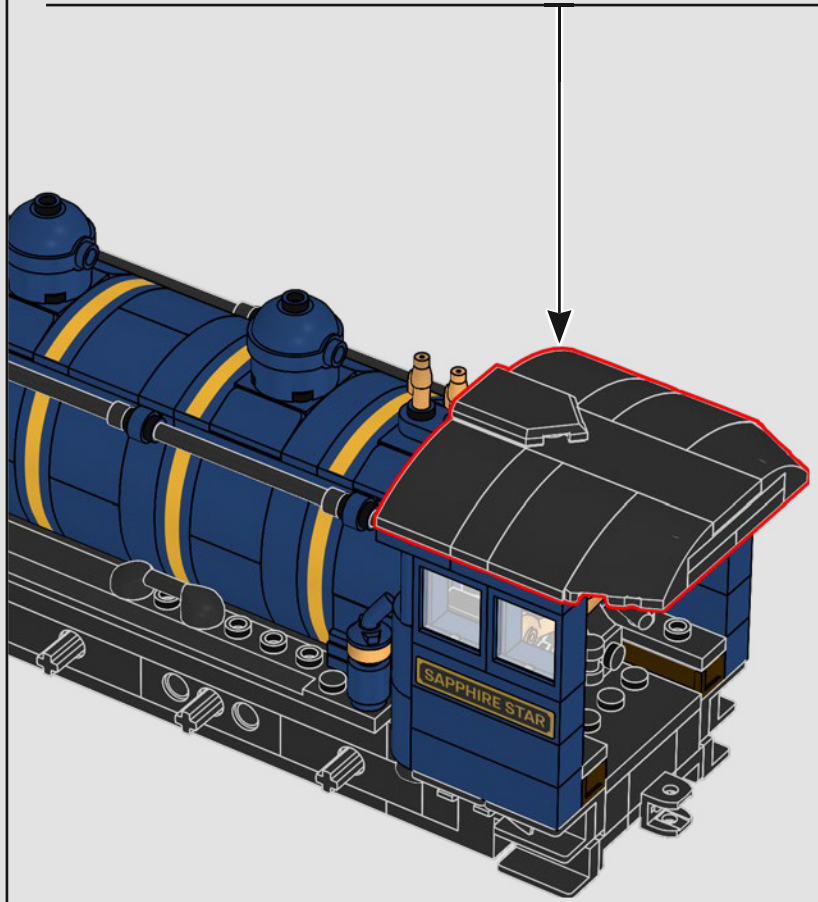
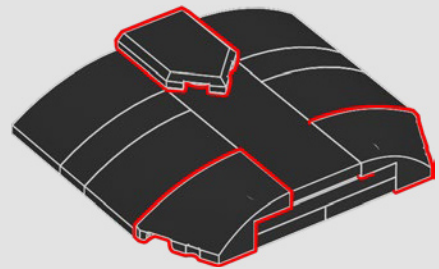

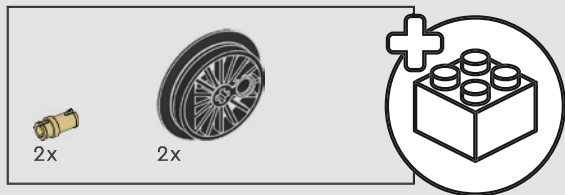

426

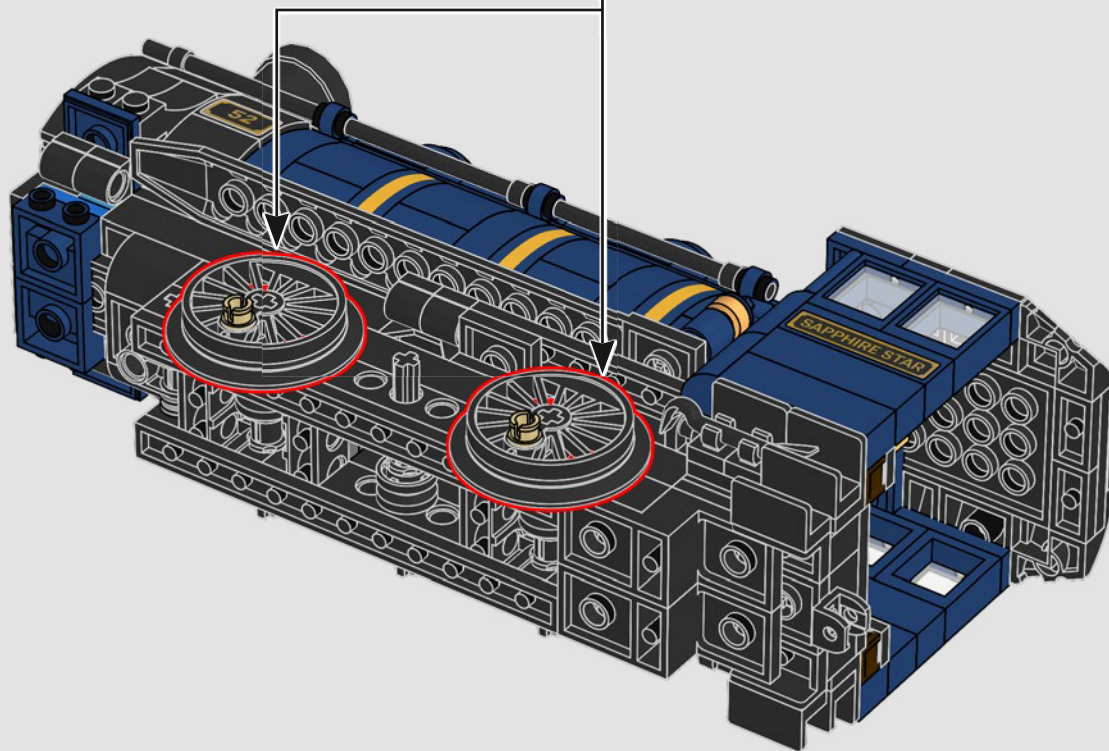
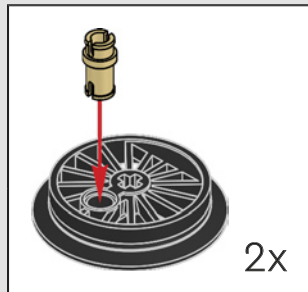

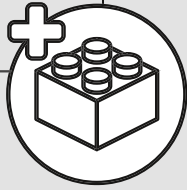

427

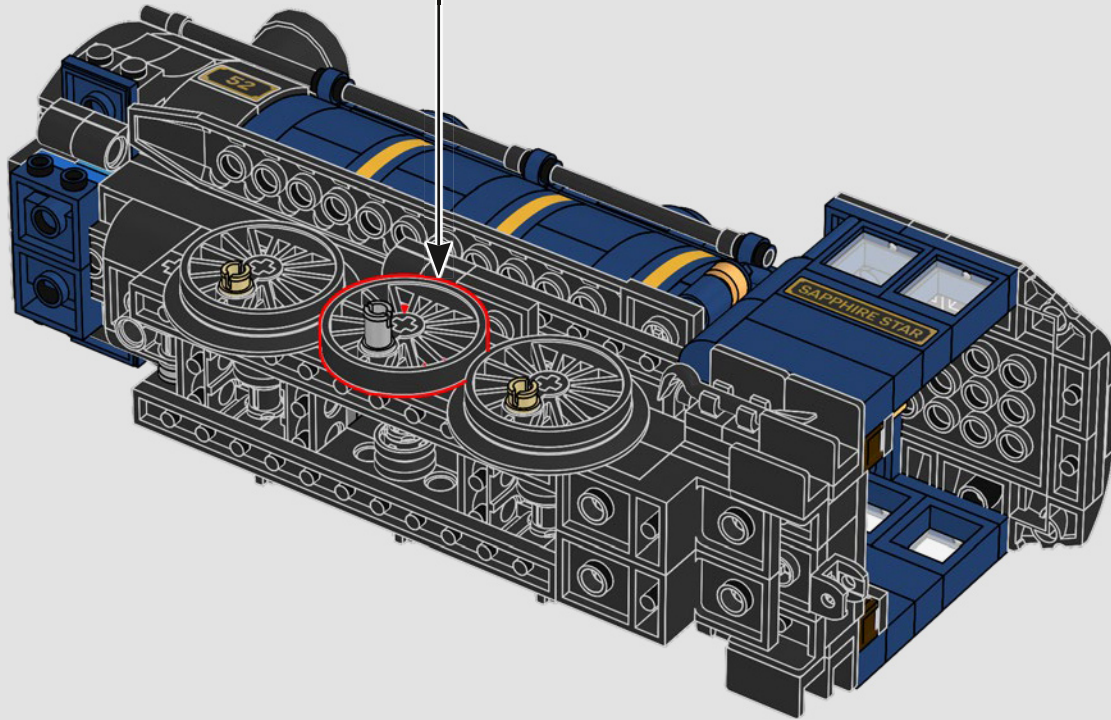
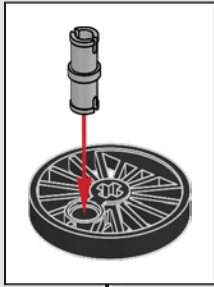

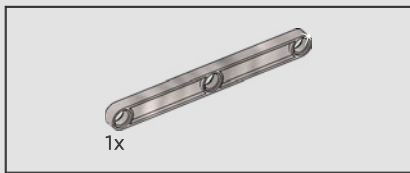

“这些银色联接杆是全新的设计，
专为这节火车头而设计。”

428

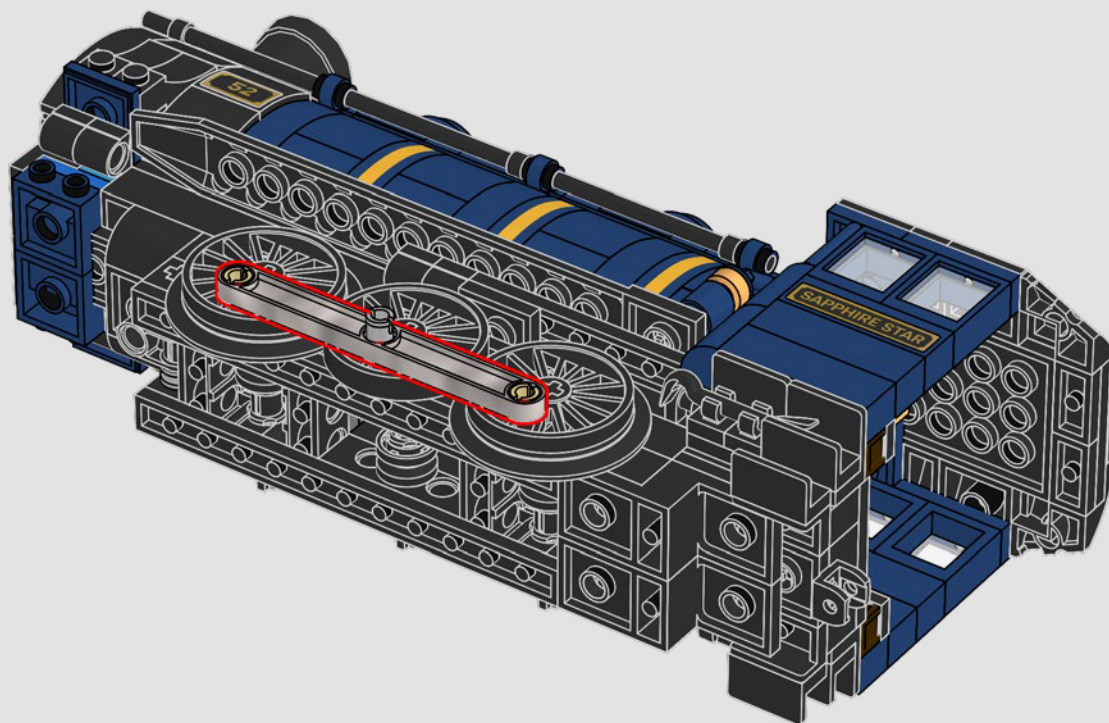



429

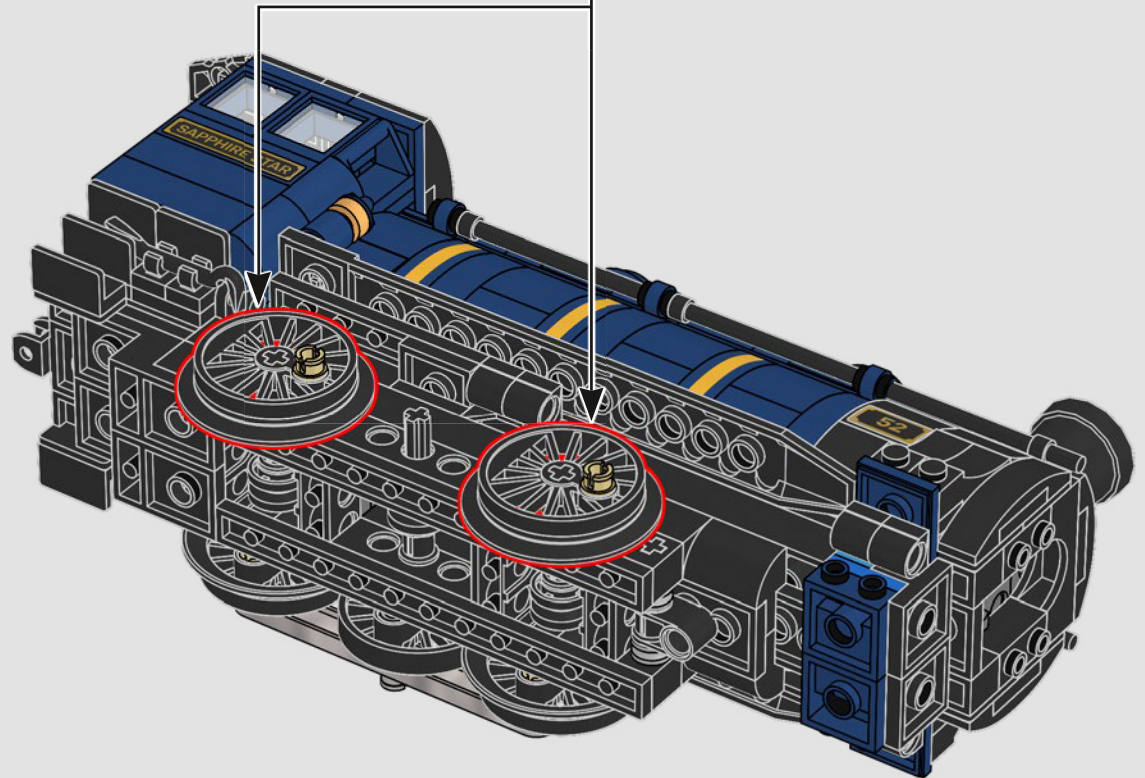
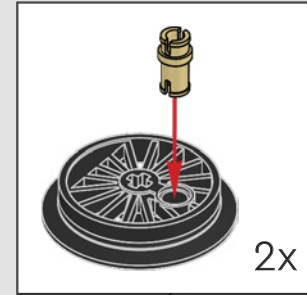
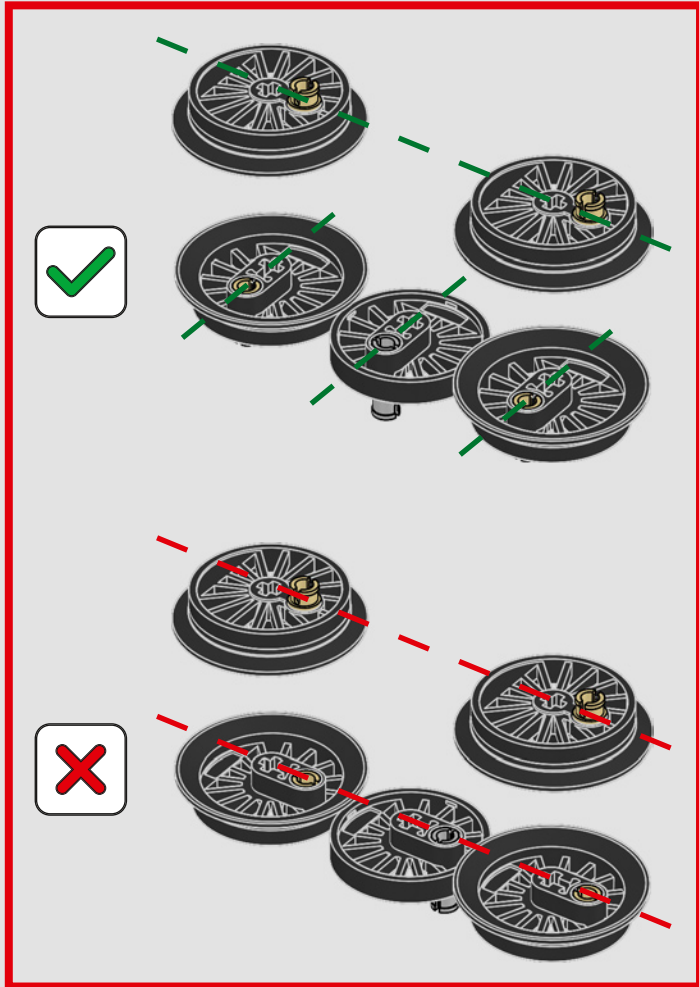



430

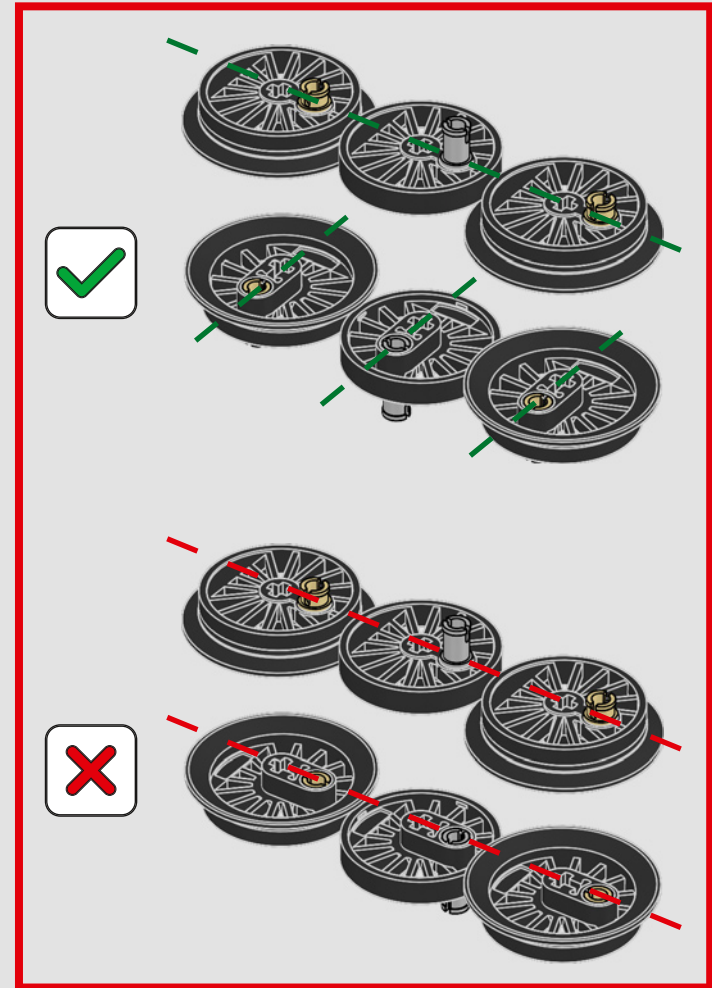
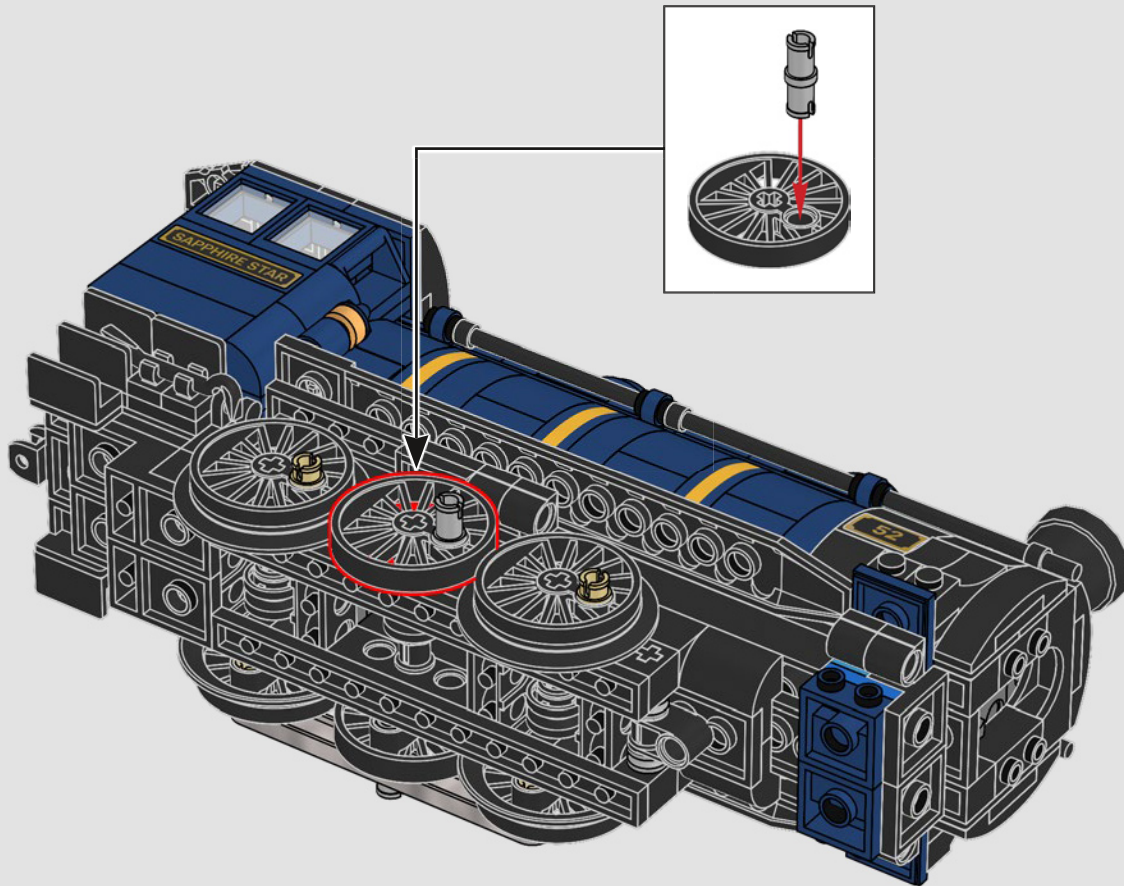

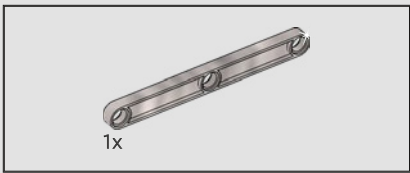

431

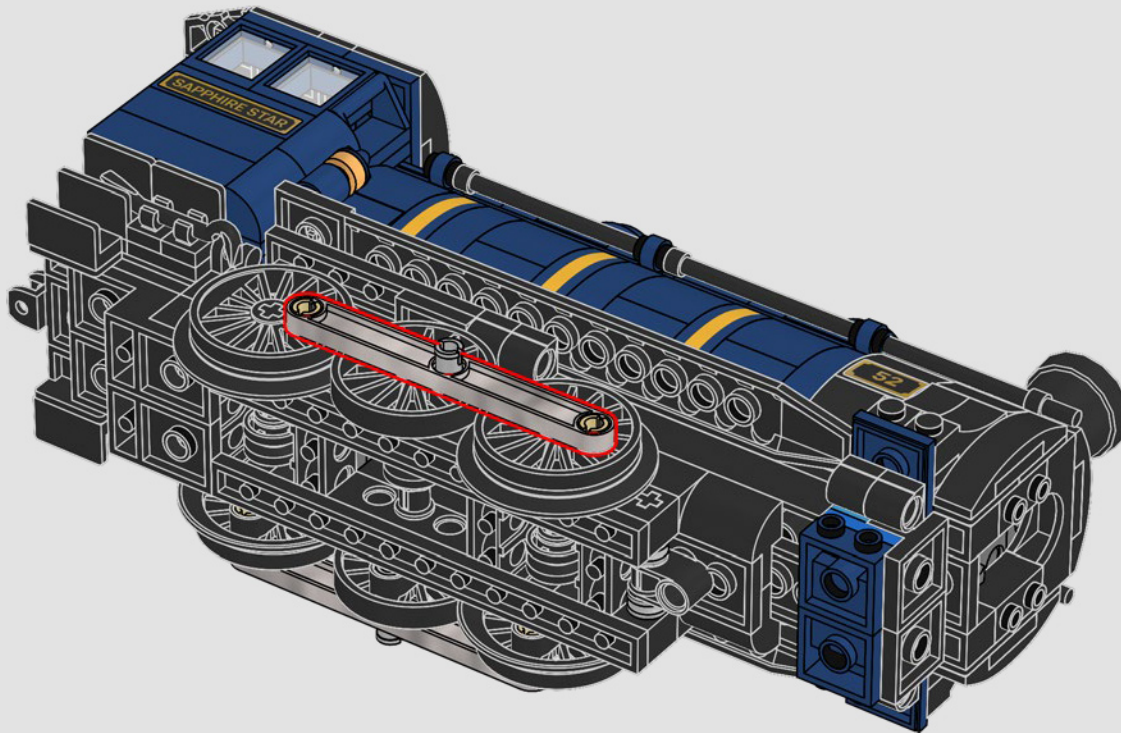

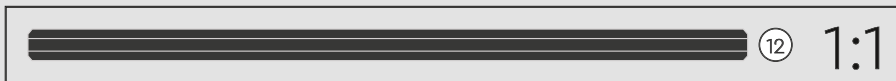
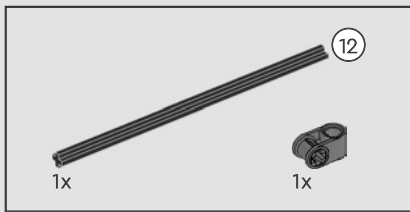

432

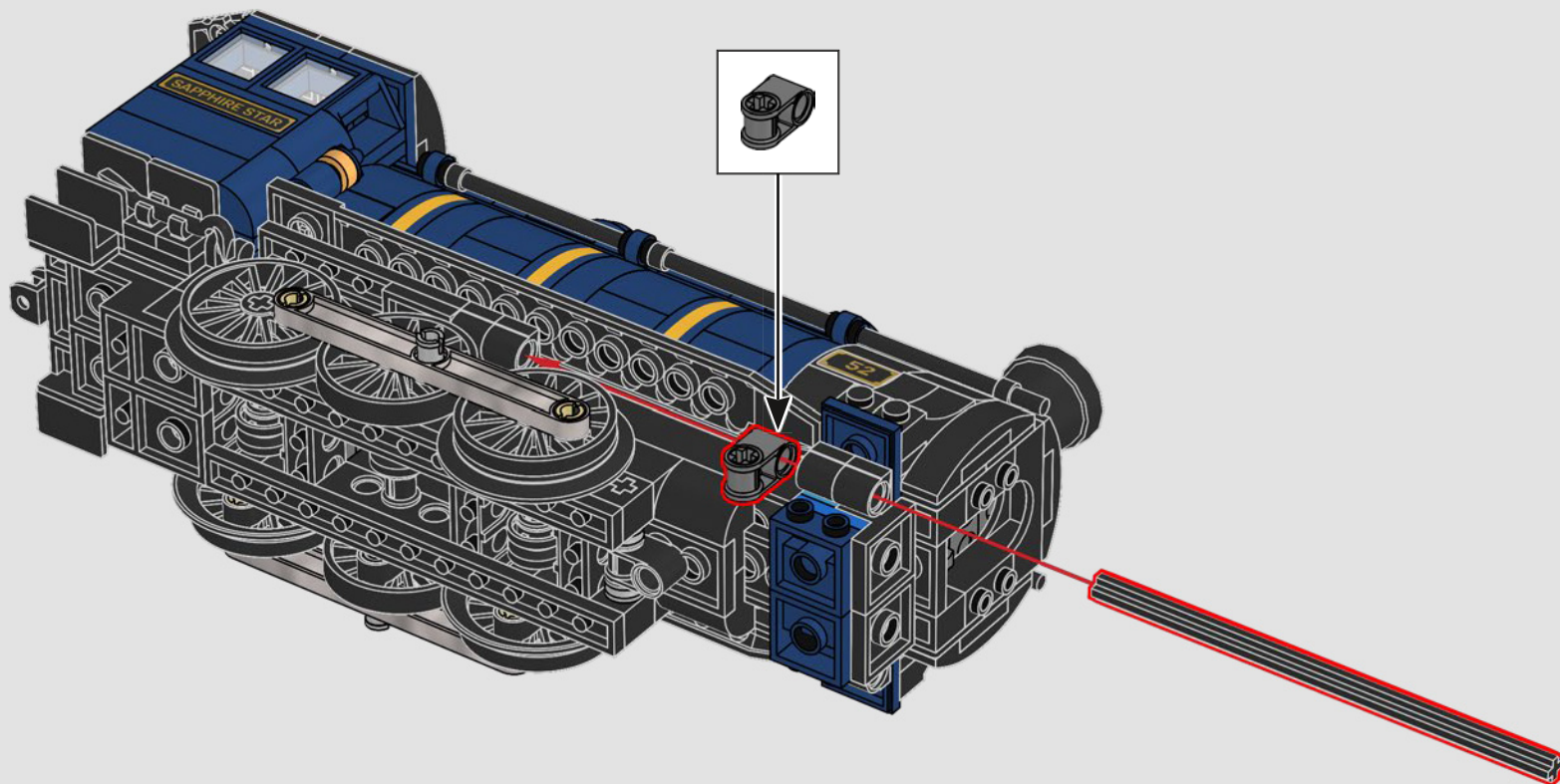

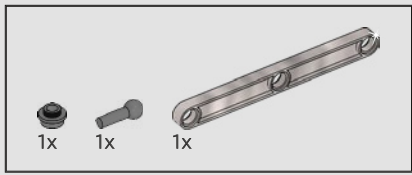

433

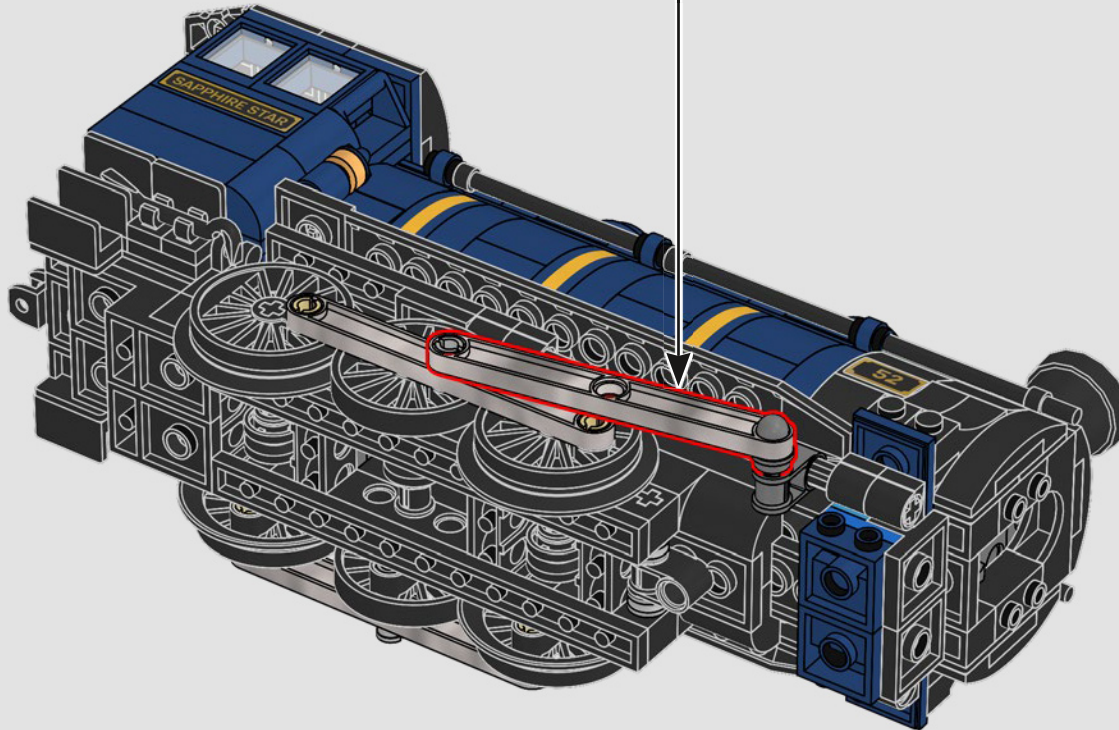
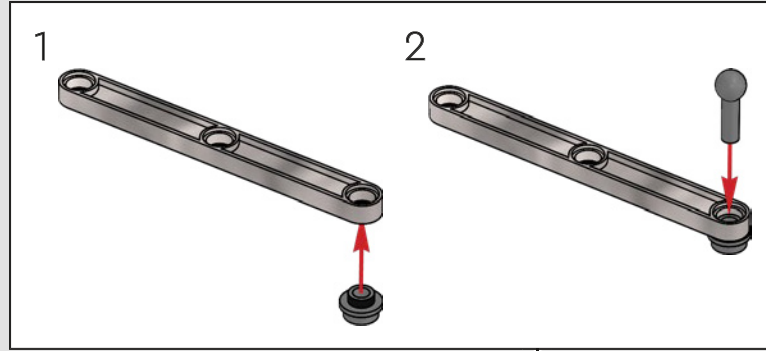

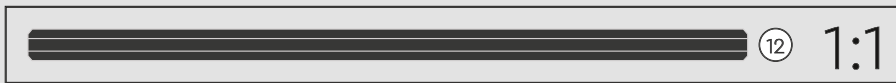
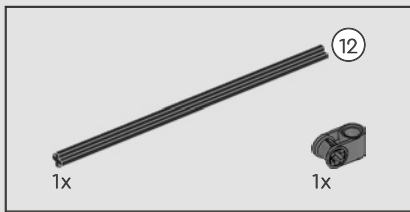

434

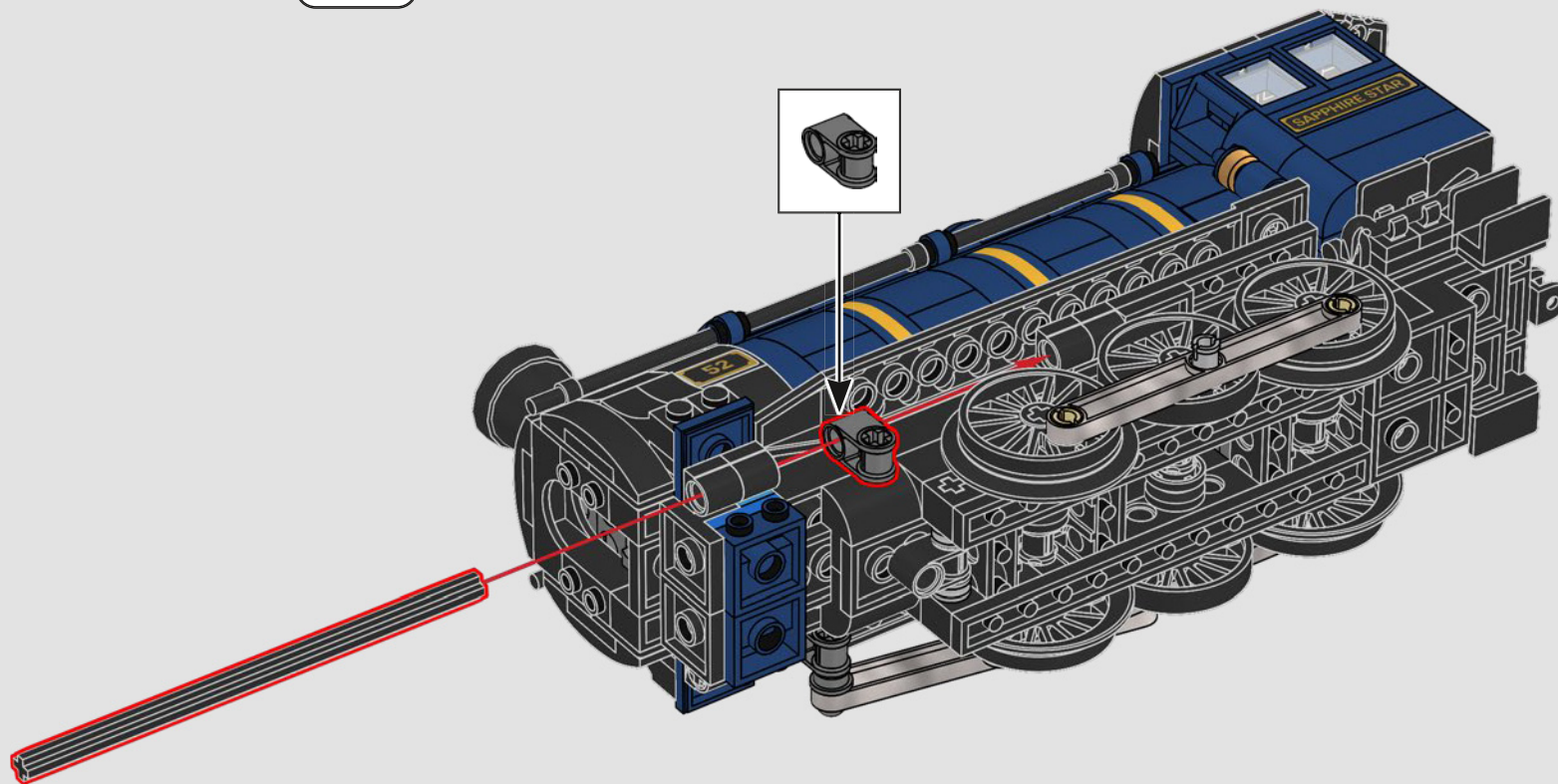

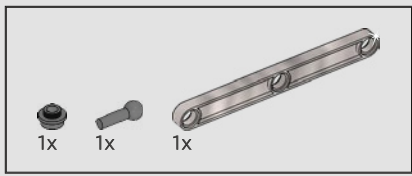

435

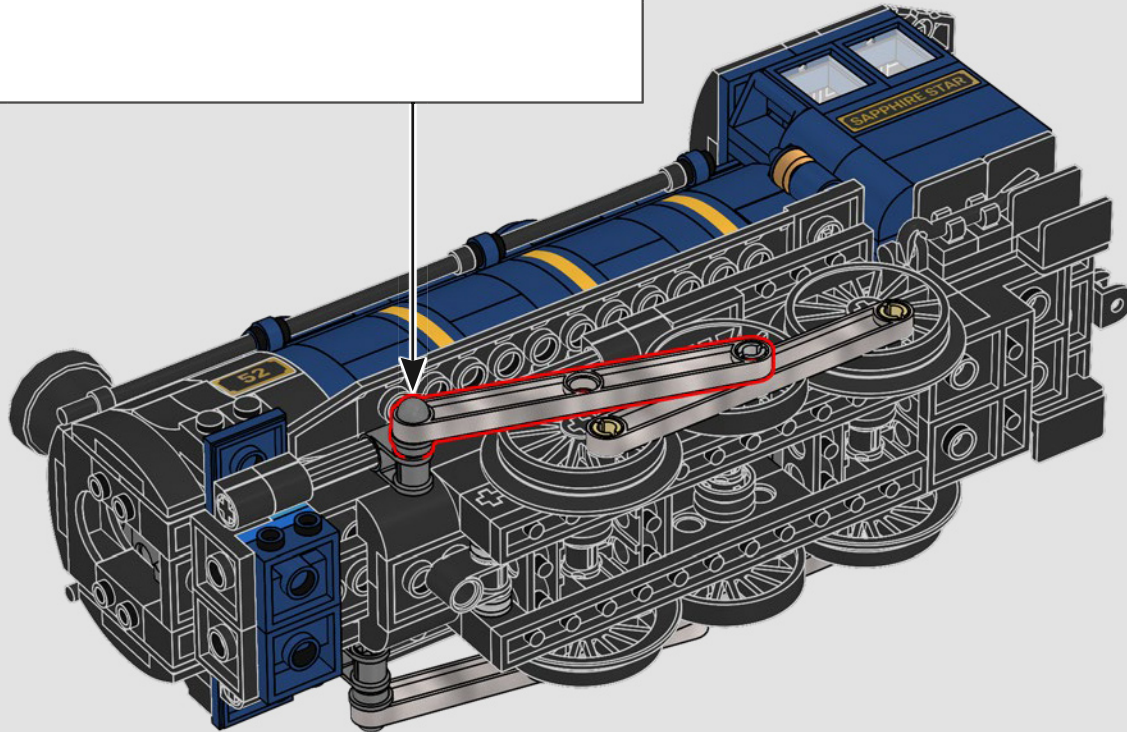
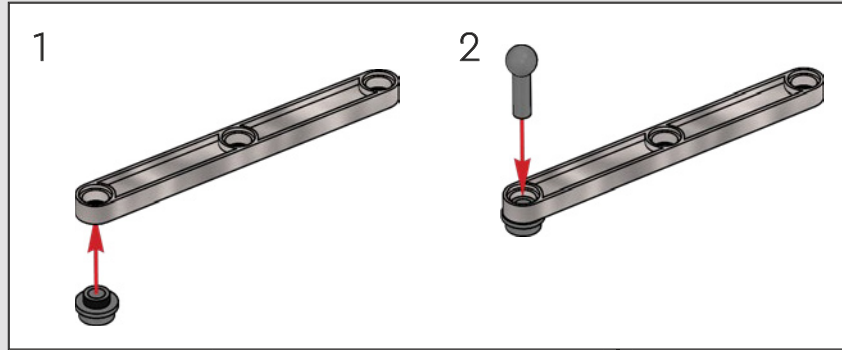

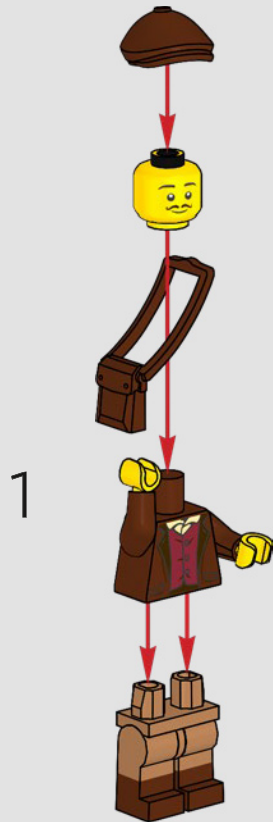
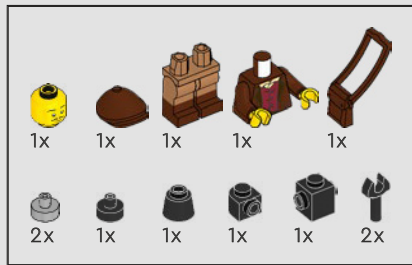

1

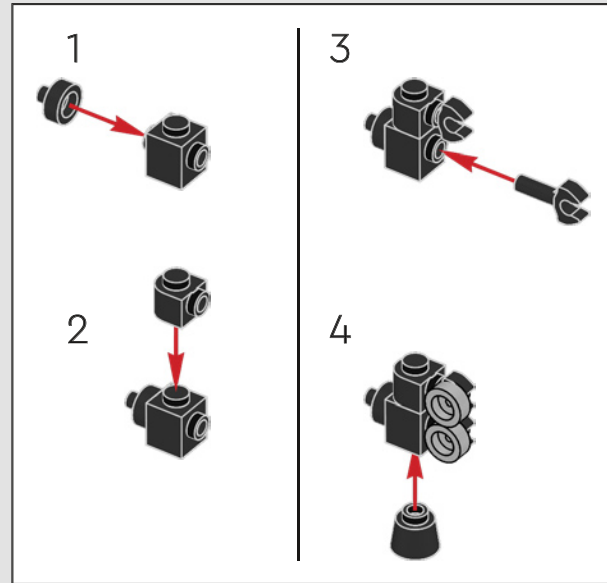

2



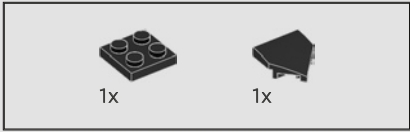
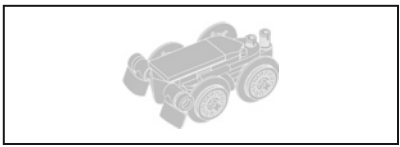

436

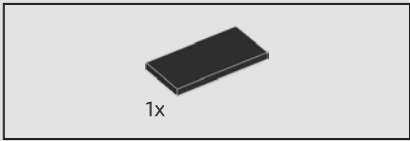
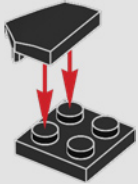

437

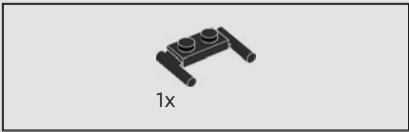
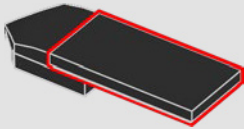

438

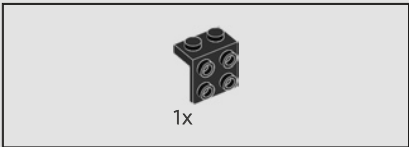
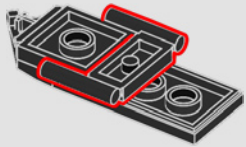

439

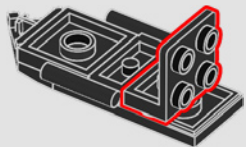

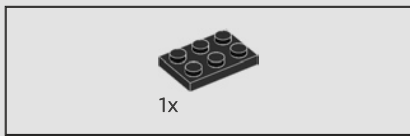

440

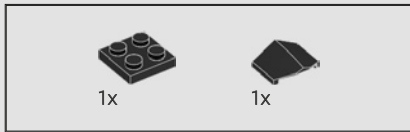
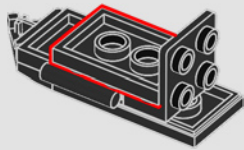

441

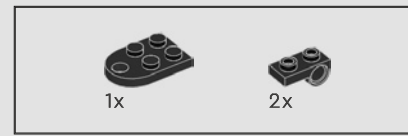
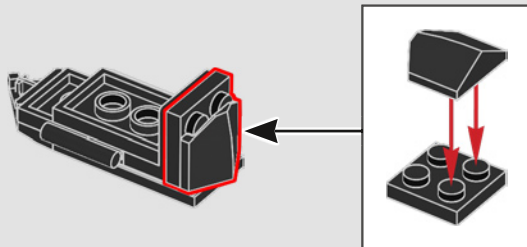

442

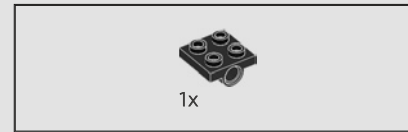
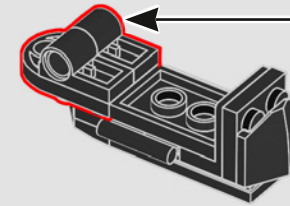
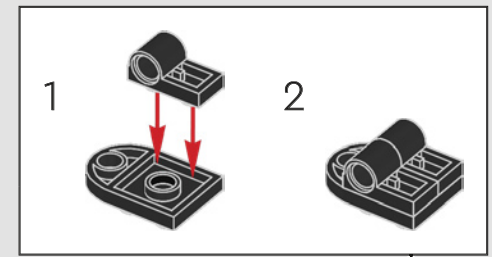

443

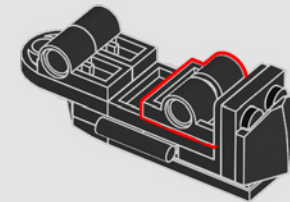

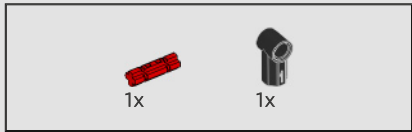
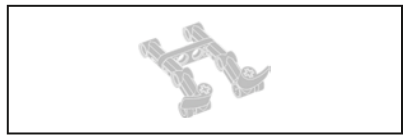

444

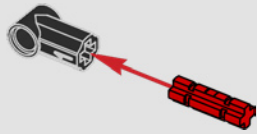

445

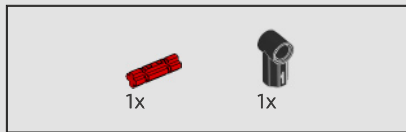

446

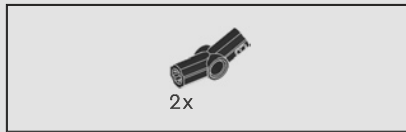
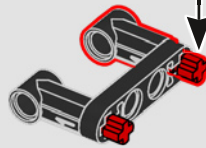
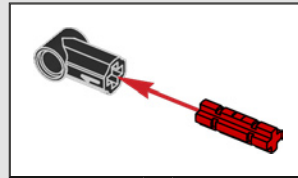

447

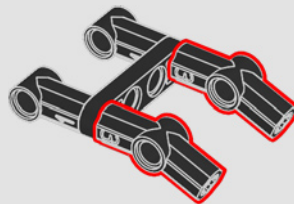

448

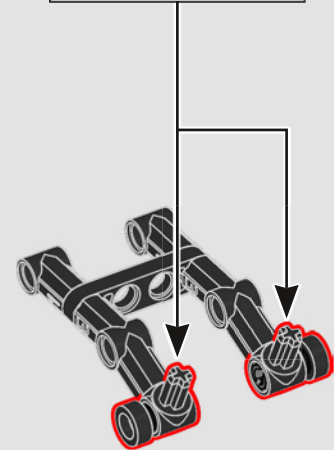
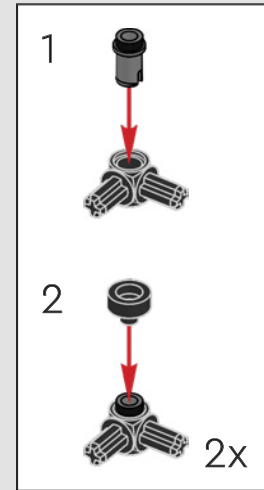



449

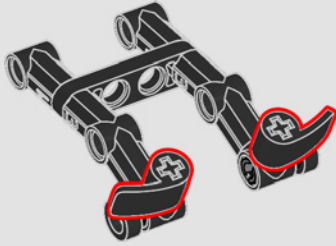

450

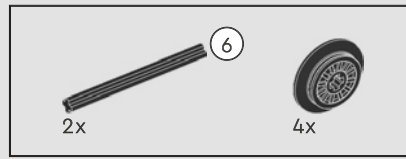
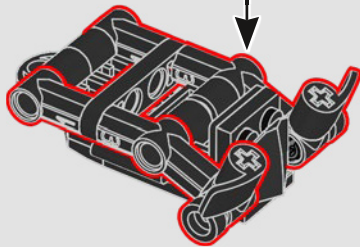

451

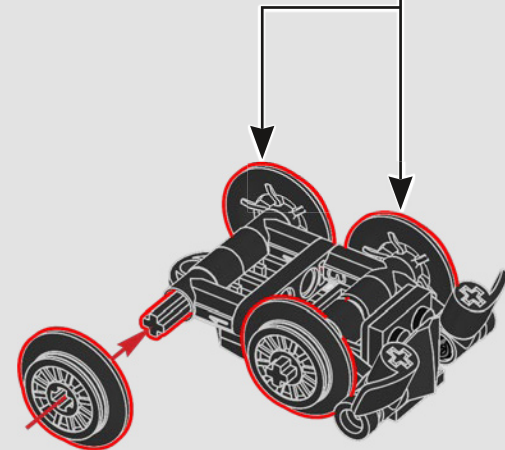
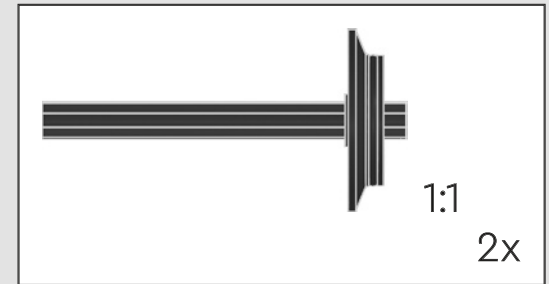
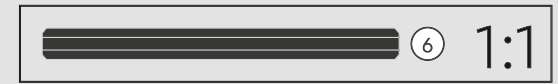

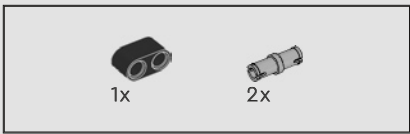

452

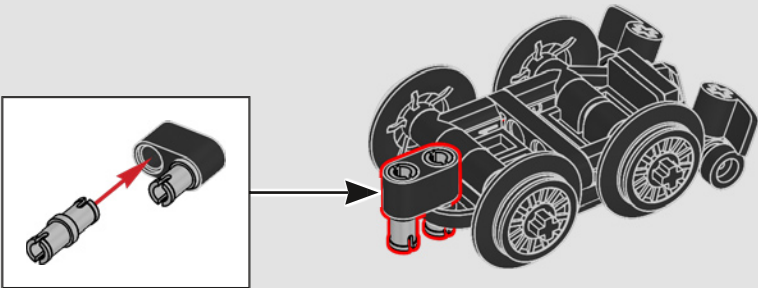

453

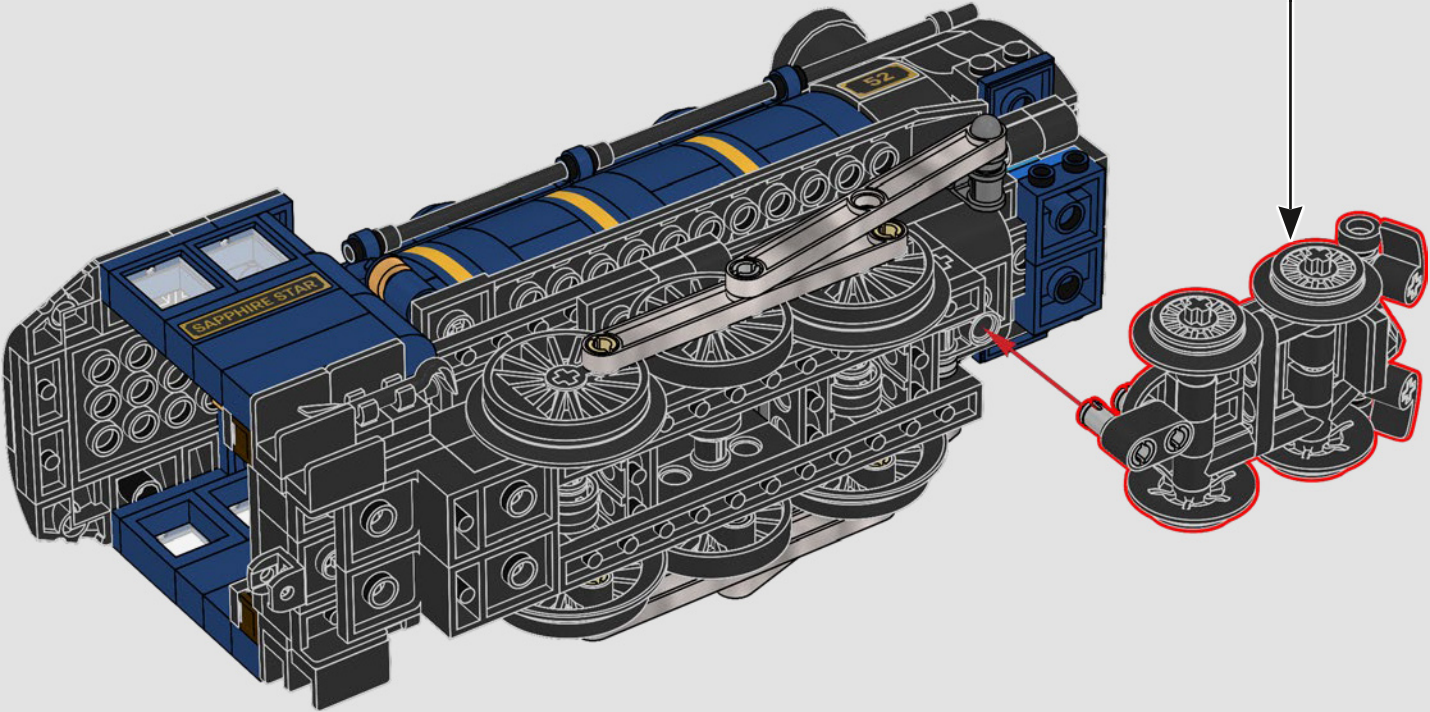

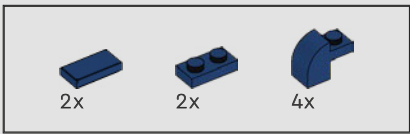

454

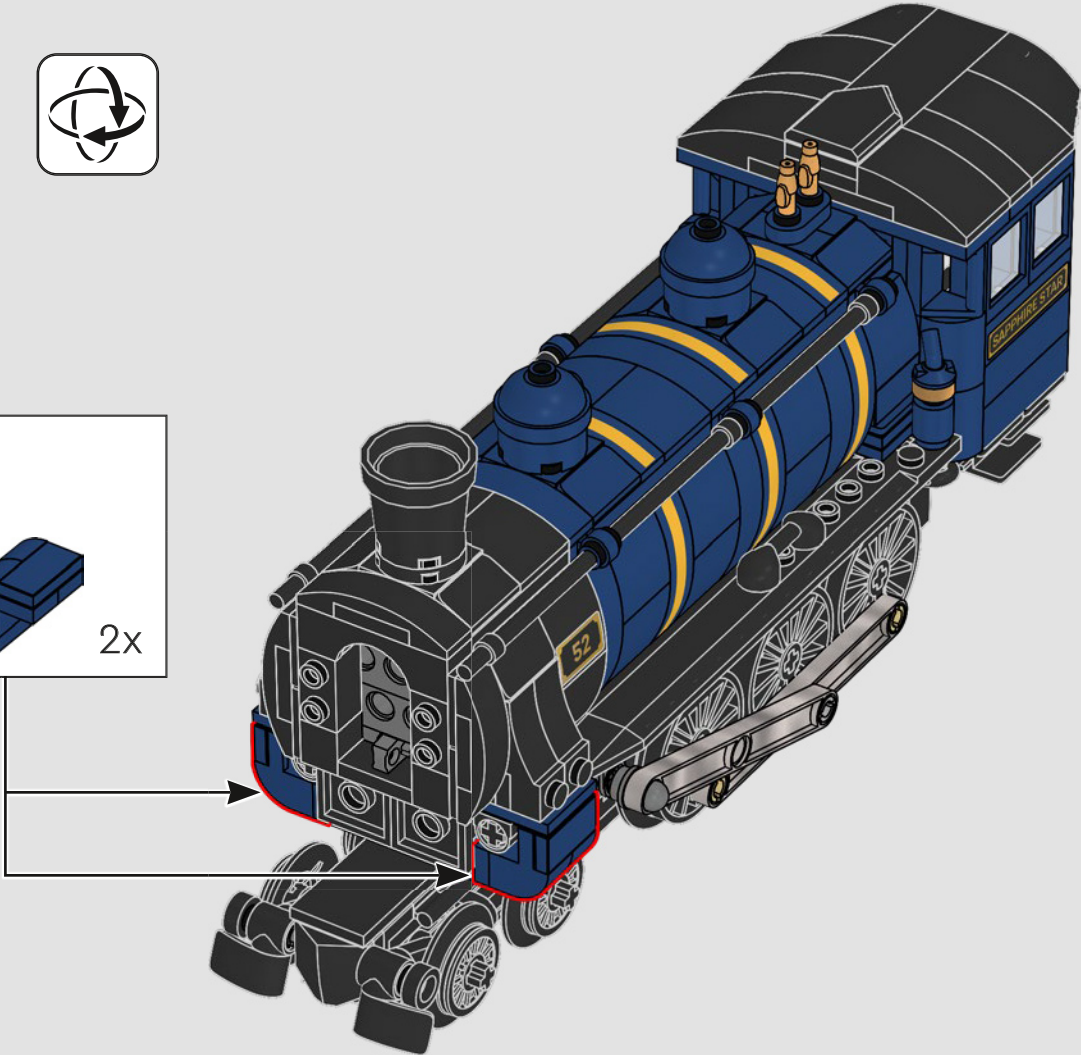
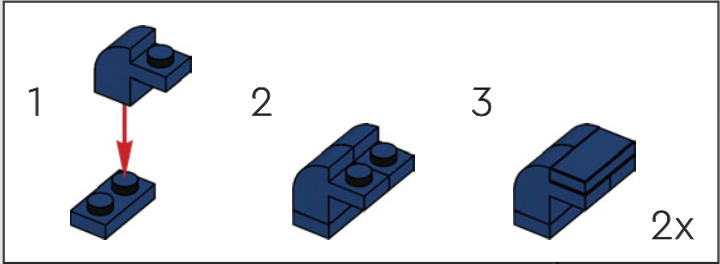

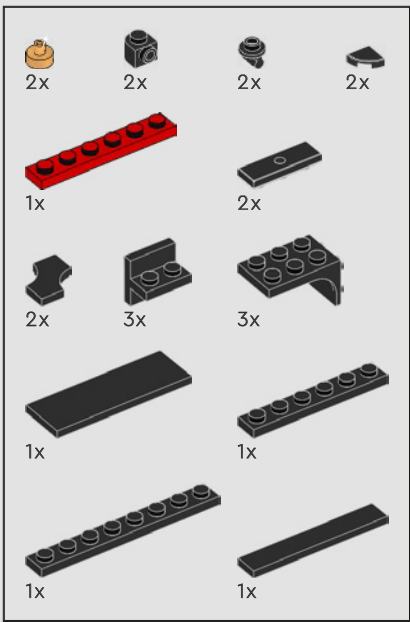

455

1

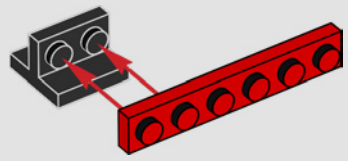

2

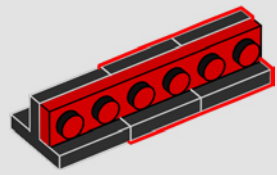

3

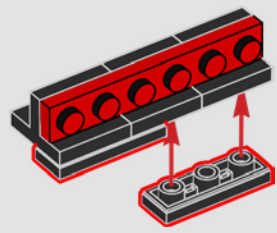

4

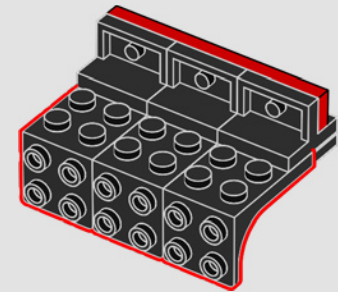

5

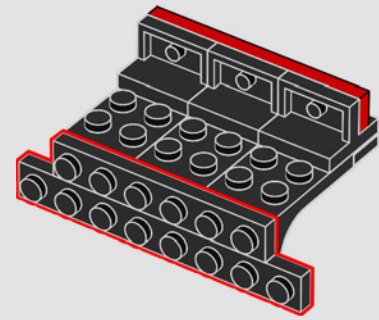

6

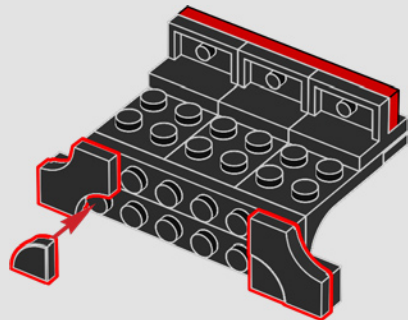

7

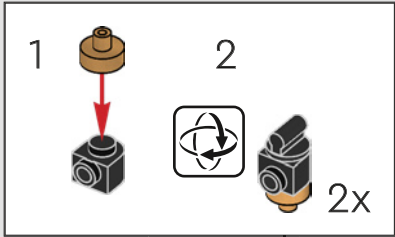
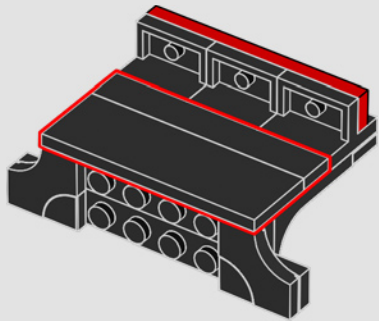

8

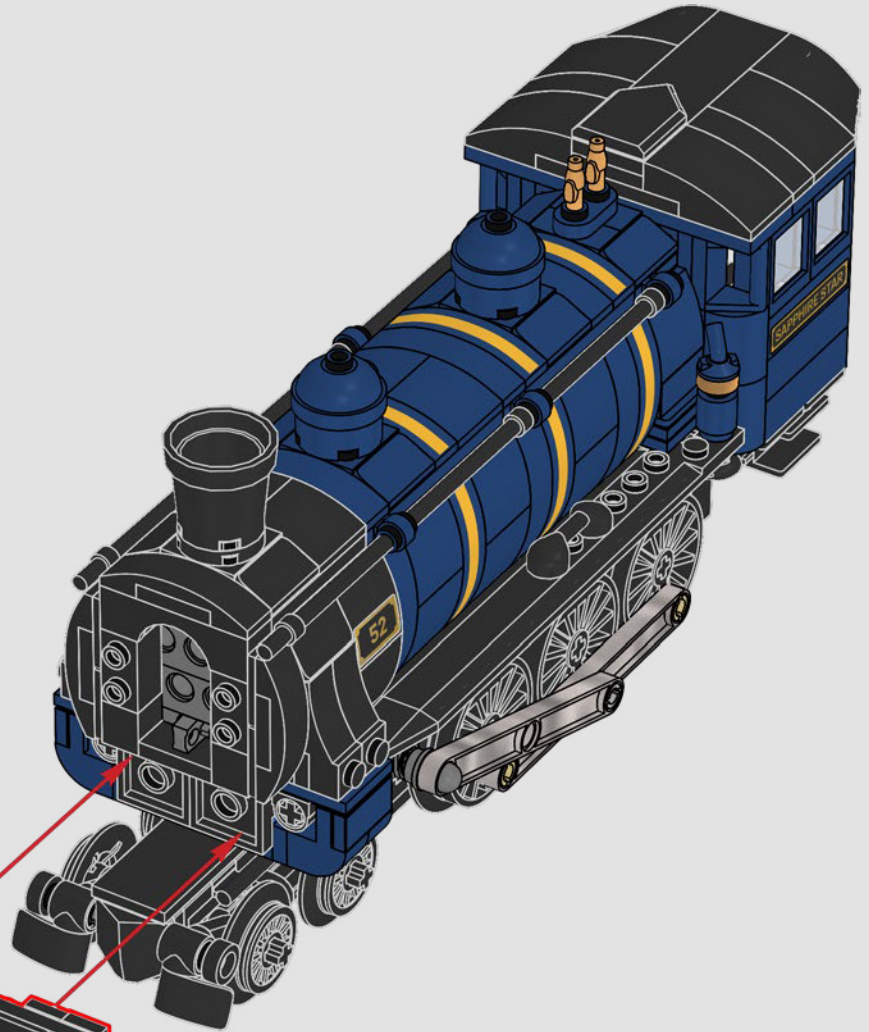
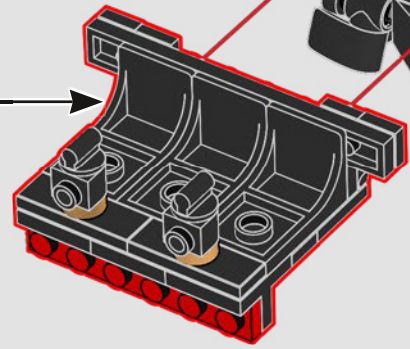
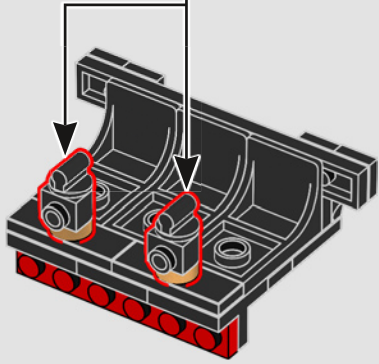

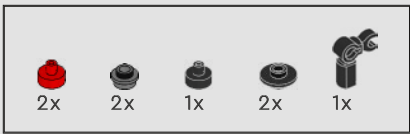

456

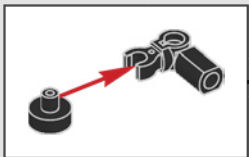
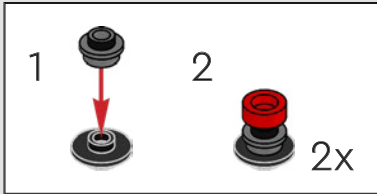
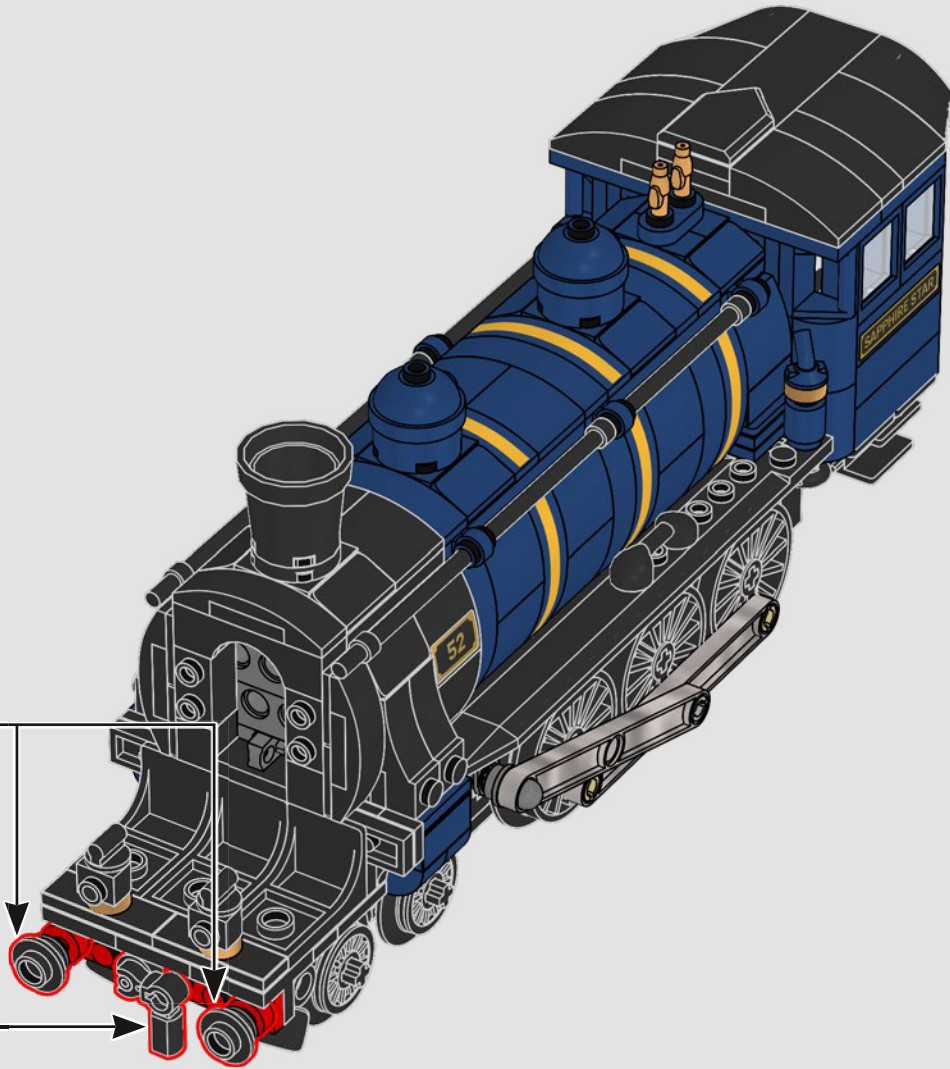

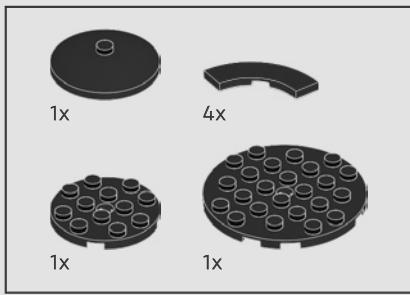

457

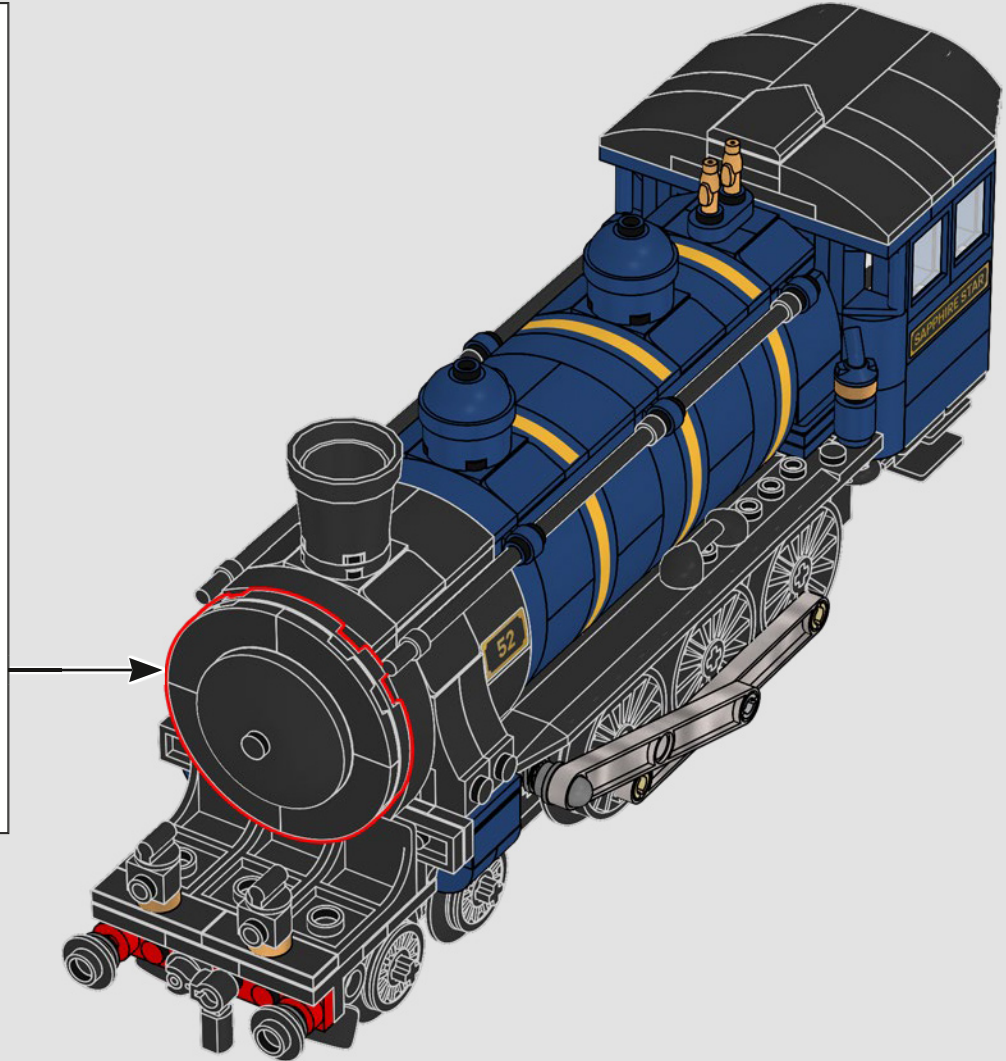
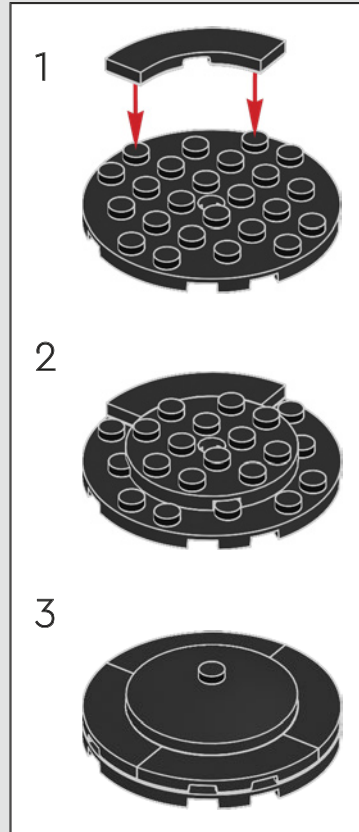



终点：伊斯坦布尔

“最后一站。从这里您可以前往巴格达、开罗、德黑兰、耶路撒冷、孟买等地！”

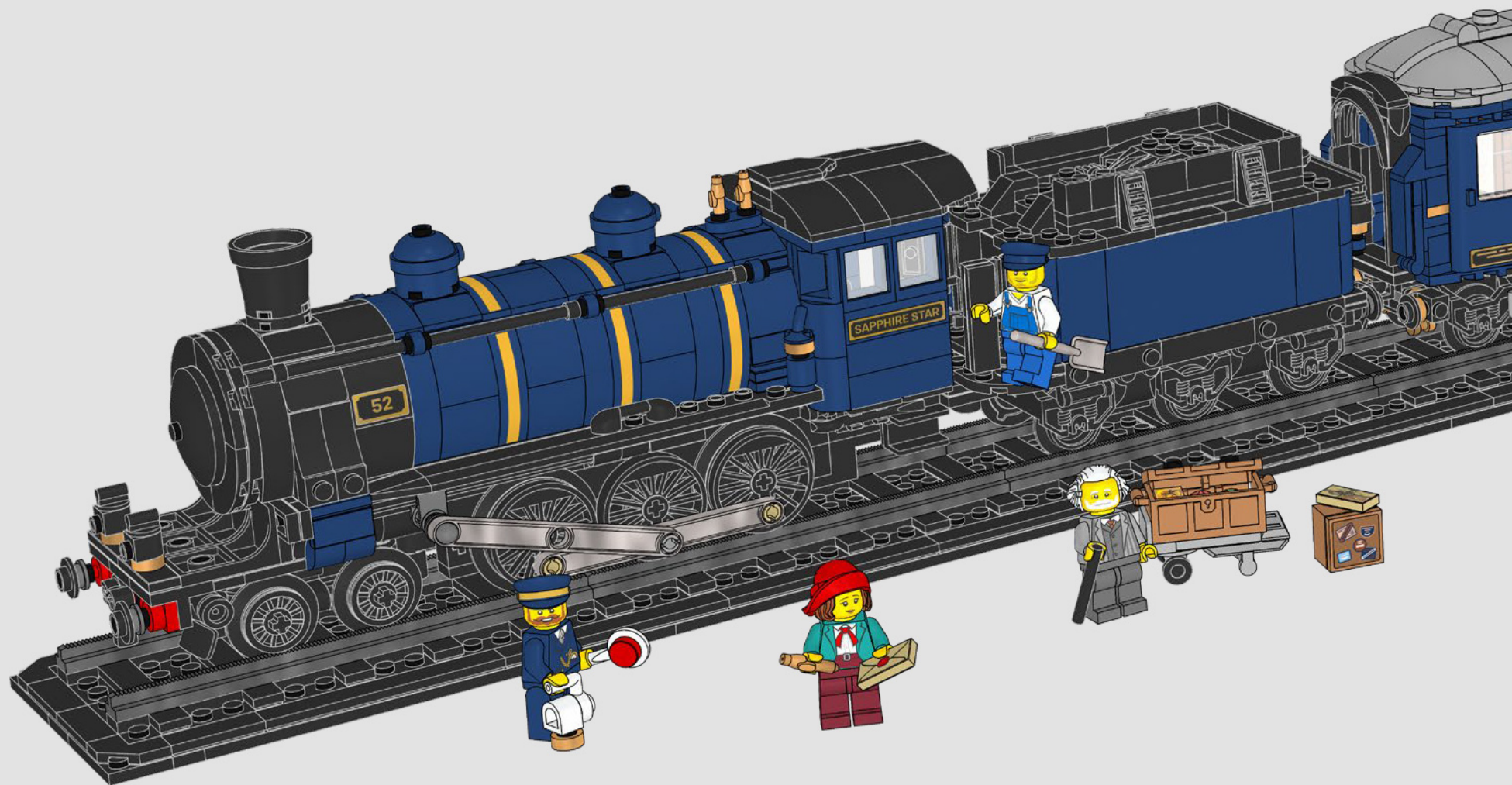

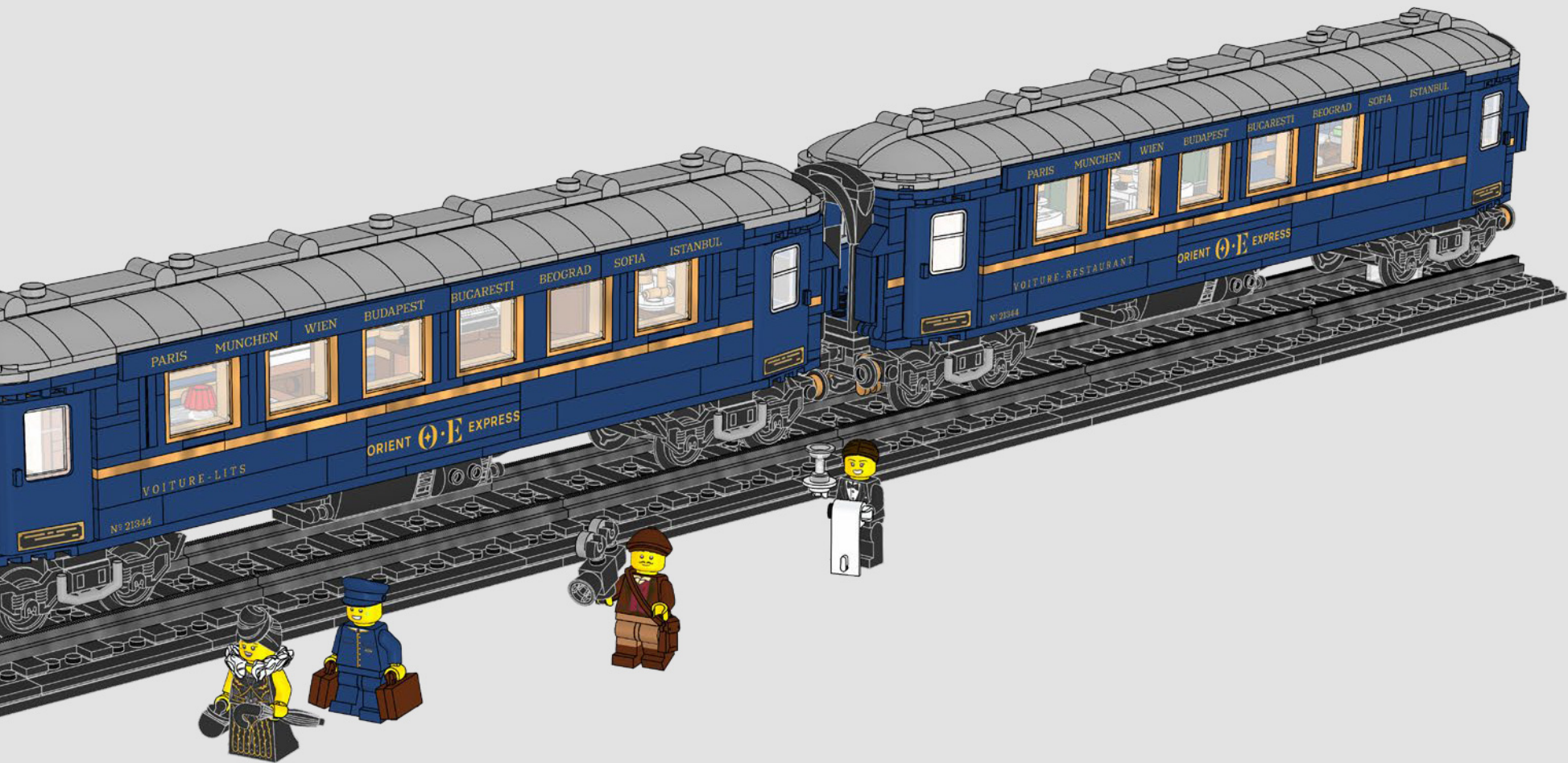



IDEAS

GATHER SUPPORT
HOL DIR UNTERSTÜTZUNG
RECUEILLEZ DES VOTES
CHIEDI DI ESSERE SUPPORTATO
CONSIGUE APOYOS
OBTÉM APOIO
争取支持
ZDOBĄDŹ GŁOSY

ZÍSKEJTE PODPORU
ZÍSKAJTE PODPORU
SZEREZZ TÁMOGATÁST!
CERE SPRIJIN
ПОЛУЧЕТЕ ПОДКРЕПА
IEGŪSTI ATBALSTU
KOGU TOĒTUST
RINK PALAIKYMĄ

SHARE YOUR IDEA
TEILE DEINE IDEE
PARTAGEZ VOTRE IDÉE
CONDIVIDI LA TUA IDEA
COMPORTE TU IDEA
PARTILHA A TUA IDEIA
分享创意
PODZIEL SIĘ POMYSŁEM

SDÍLEJTE SVÉ NÁPADY
ZDIEĽAJTE SVOJE NÁPADY
OSZD MEG AZ ÖTLETED!
ÎMPĂRȚĂȘEȘTE IDEEA TA
СПОДЕЛЕТЕ ИДЕИТЕ СИ
PARĀDI SAVU IDEJU
JAGA OMA IDEED
PASIDALINK SAVO IDĒJA

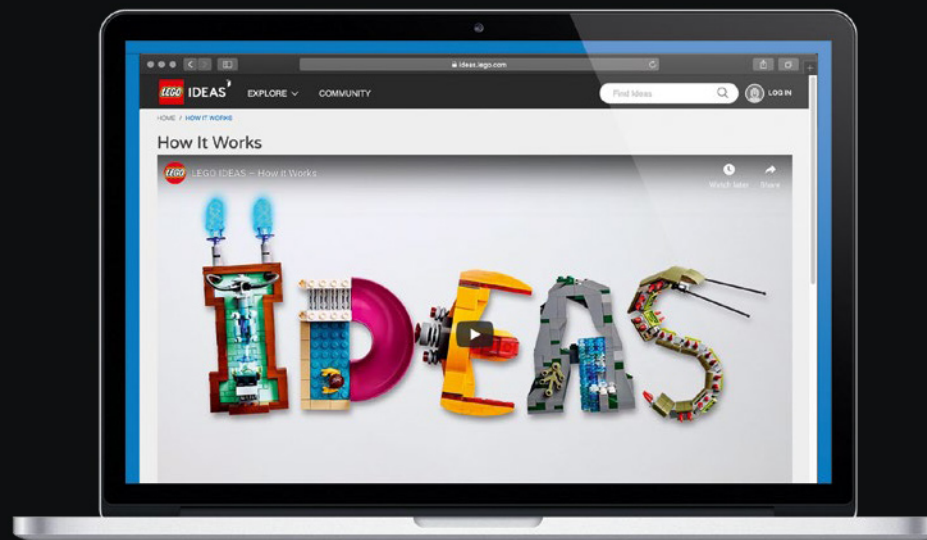
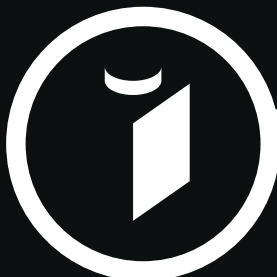
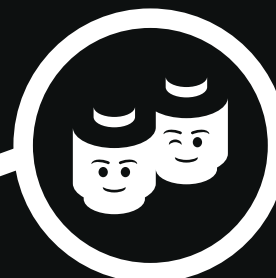

LEGO® REVIEW
LEGO® PRÜFUNG
EXAMEN PAR LEGO®
REVIEW LEGO®
REVISIÓN DE LEGO®
AVALIAÇÃO LEGO®
乐高®审核
OCENA LEGO®

OUZENÍ DESIGNÉRY LEGO®
POSÚDENÉ DIZAJNÉRMÍ LEGO®
LEGO® VÉLEMÉNYEZÉS
VERIFICARE LEGO®
ПРЕГЛЕД НА LEGO®
LEGO® RECENZJA
LEGO® ARVUSTUS
LEGO® APŽVALGA

NEW LEGO® PRODUCT
NEUES LEGO® PRODUKT
NOUVEAU PRODUIT LEGO®
NUOVO PRODOTTO LEGO®
NUEVO PRODUCTO LEGO®
NOVO PRODUTO LEGO®
全新乐高®产品
NOWY PRODUKT LEGO®

NOVÁ STAVEBNICE LEGO®
NOVÁ STAVEBNICA LEGO®
ÚJ LEGO® TERMÉK
PRODUS LEGO® NOU
НОВ ПРОДУКТ LEGO®
JAUNS LEGO® PRODUKTS
UUS LEGO® TOODE
NAUJAS LEGO® PRODUKTAS

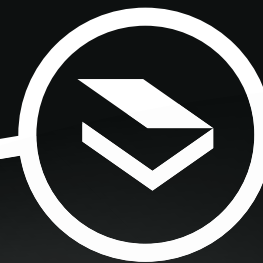

ideas.LEGO.com

1x 407001	1x 6434569	1x 474001	1x 4114084	4x 306223	1x 6123730	16x 306226	1x 6181713	1x 4177444	5x 301026	4x 303226
1x 4558952	3x 302301	1x 6172674	1x 6257600	2x 6055065	1x 6218310	2x 6436425	2x 6369578	1x 6261371	4x 371026	14x 303426
1x 6321349	1x 302201	2x 4537987	1x 6352222	2x 6092582	1x 6384058	2x 6344819	1x 6308912	2x 6396456	8x 6254045	3x 346026
1x 6218823	2x 6126046	1x 4527637	2x 6174925	12x 302223	1x 6384051	4x 4548180	4x 6211476	4x 302426	8x 243126	3x 346026
1x 6218823	1x 6415097	1x 6219621	4x 6013938	1x 6315482	1x 6434805	1x 6323421	2x 6458098	110x 302326	8x 243126	3x 346026
2x 6383982	1x 4558168	1x 6334236	2x 6215539	4x 9341	1x 6288000	2x 6267487	4x 4200023	6x 3069226	10x 302026	4x 447726
1x 306201	7x 6195371	1x 390001	1x 6284574	1x 300423	1x 6372016	1x 6273589	6x 6053077	4x 241226	3x 4560182	4x 303526
2x 6442360	7x 302101	6x 6475151	1x 6465499	4x 300423	1x 6352820	1x 6181720	1x 6390748	4x 6092585	1x 6076678	2x 6037390
1x 6050914	1x 6446788	4x 6235083	4x 6454454	2x 4558606	6x 6186675	4x 6138173	4x 6328095	4x 242026	1x 663626	4x 4514845
2x 4547489	1x 6348055	1x 6396958	2x 4142865	4x 301023	26x 407026	2x 265326	2x 4251161	19x 302226	3x 366626	2x 611226
1x 6213880	1x 6437184	4x 6238334	2x 6397571	8x 447723	13x 6228987	2x 4162443	1x 6390749	20x 6192346	5x 4243819	2x 244526
2x 6258135	2x 6168618	2x 4114026	1x 6284163	1x 362321	1x 4214559	2x 370126	4x 6147790	2x 6133722	2x 6318582	18x 428226
1x 6213881	6x 6449595	1x 6284163	1x 6455324	1x 6217123	2x 300426	2x 6039194	7x 4613153	8x 4558170	2x 379526	8x 6094066
2x 6248827	2x 6132203	4x 6286329	1x 6286329	1x 383223	2x 235726	2x 365926	2x 365926	6x 6199908	2x 379526	
1x 6285777	1x 6093053	1x 6375672	1x 6375672	7x 300121	3x 300326	4x 4587844	5x 6162892	5x 302126	82x 416226	
3x 6299937	2x 6023806	1x 4113916	1x 4113916	1x 366621	2x 244523	2x 6222427	4x 4587844	5x 6162892	82x 416226	



























































































6x 6335388	4x 6424674	3x 6284070	1x 403226	1x 6104209	4x 6172383	8x 6156991	1x 4666322	1x 6134251	1x 6247798
2x 6272184	4x 6380236	6x 4225201	1x 6143850	1x 6093525	10x 6433936	12x 4541191	6x 6361813	2x 6058089	4x 6454463
4x 6310981	4x 6335317	1x 281726	1x 6428168	6x 6170421	1x 6420852	1x 6452332	6x 6315198	1x 6253418	1x 6186867
4x 4161332	8x 6234695	7x 6273226	16x 6191630	1x 9339	1x 6438919	3x 6195185	2x 6315198	1x 6253418	6x 6449836
4x 4161332	3x 6157554	1x 317626	4x 4227392	1x 9339	8x 6173959	5x 6394979	2x 6441768	3x 6408240	4x 6254552
1x 4180536	2x 6330189	3x 6416838	8x 6331483	1x 6431021	1x 6192778	1x 6245251	2x 6143431	3x 6408240	4x 6254552
4x 4160869	8x 6313116	4x 6118829	1x 396026	1x 6430624	1x 6454452	5x 6356406	5x 6186012	2x 6219673	8x 6410188
1x 4180508	2x 243226	6x 6168620	13x 4515350	1x 6438667	2x 6151289	2x 6439039	1x 6092602	2x 6219673	23x 6278710
4x 6284697	10x 6192309	8x 6099483	4x 6434275	1x 6203937	5x 6331084	3x 6332148	4x 4570877	9x 6359273	1x 6258607
1x 6057902	2x 6117973	1x 383926	1x 6187587	1x 6454457	1x 249626	2x 6284699	1x 4615606	1x 6340042	1x 6247785
4x 6284697	20x 6000650	3x 6468138	1x 6327548	1x 6290456	22x 6253473	1x 6338384	4x 4570877	1x 6359041	1x 6247793
1x 6057902	2x 6016172	4x 6401209	4x 4106347	1x 6359833	4x 6284110	3x 6291068	2x 6186423	1x 6429033	1x 6247788
2x 6236464	4x 6310268	1x 6057903	4x 6146220	2x 6186698	1x 4600178	2x 6099801	2x 6186007	3x 6252041	1x 6247364
2x 370826	4x 4107761	1x 6057903	4x 6146220	8x 6395769	1x 4600178	2x 6261386	2x 6186007	1x 6220959	1x 6464185
2x 4527604	10x 6250020	1x 6161298	1x 6408578	13x 6475153	4x 6443446	1x 370526	1x 6074893	1x 6239418	1x 6254100
					11x 6253474	5x 370626			

12

4

6

- 17x 4255413
- 40x 4249891
- 2x 6454453
- 4x 6228123
- 4x 6453215
- 22x 6233955
- 13x 4264569
- 1x 6275133
- 2x 6463543
- 4x 6465404
- 2x 6463544
- 12x 6277303
- 1x 6224377
- 4x 6256616
- 2x 6429965
- 5x 6135606
- 2x 4177741
- 6x 6216905
- 8x 6186683
- 1x 6214811
- 1x 6214812
- 12x 6384915
- 4x 6411363
- 16x 6061569
- 9x 6037886
- 9x 6453216
- 4x 6464198
- 62x 4184108
- 2x 6092588
- 32x 4528981
- 20x 4528488
- 12x 6037890
- 2x 4205004
- 8x 6132566
- 41x 4177735
- 7x 4502089
- 1x 6256610
- 4x 4569836
- 5x 6384913
- 2x 4508313
- 4x 6453208
- 12x 6250216
- 4x 6453207
- 8x 4507080
- 4x 6453209
- 4x 6453210
- 5x 6027627
- 4x 6106692
- 12x 6200663
- 2x 6429734
- 2x 6454464
- 8x 6120642
- 7x 6328107
- 2x 6097457
- 2x 6224472
- 2x 6371455
- 20x 6464203
- 2x 6470186
- 4x 6407191
- 1x 6236571
- 8x 4502091
- 8x 4529954
- 8x 6251836
- 4x 6382723
- 1x 6253883
- 8x 6450823
- 4x 6254479
- 2x 6409752
- 1x 6410902
- 2x 6391515
- 2x 4162916
- 1x 6463580
- 1x 6409766
- 4x 6454450
- 4x 6454451
- 4x 6315608
- 1x 6435099
- 1x 6308322
- 1x 6252040
- 8x 6171727
- 4x 4538760
- 2x 4210762
- 1x 4213607
- 1x 4211000
- 2x 6336390
- 1x 6266248
- 4x 6350292
- 8x 4225733
- 6x 6231765
- 1x 4222693
- 2x 6261374
- 4x 4211063
- 1x 4211055
- 2x 4211043
- 4x 4211065
- 4x 4211002
- 2x 6313652
- 2x 4211067

 2x 6258831	 5x 6171894	 1x 6146223	 1x 6201911	 2x 6253167	 2x 6149677	 1x 6236915
 10x 6284071	 4x 4211396	 1x 6468371	 1x 6468374	 1x 6397820	 5x 6341553	 4x 6172636
 4x 4211386	 16x 4211445	 1x 6195471	 1x 6408343	 2x 6322211	 2x 6238874	 12x 6168623
 2x 6123809	 4x 4211395	 1x 6152344	 2x 6268857	 3x 6311210	 4x 6226436	 1x 4211159
 8x 6407412	 8x 4560183	 1x 6152344	 1x 6270078	 16x 6172922	 1x 6290983	 1x 6037289
 24x 6262085	 1x 6402193	 8x 4644102	 2x 6329114	 1x 6365885	 2x 6251470	 1x 6102360
 8x 4251163	 4x 4211425	 4x 4494475	 6x 4211242	 2x 6409552	 1x 4211190	 1x 6342958
 76x 6132207	 4x 4211425	 2x 6271165	 2x 6177699	 2x 6299939	 6x 6257604	 2x 4283660
 2x 4211435	 2x 4211407	 4x 4211807	 2x 4211180	 2x 6325975	 2x 4211186	 1x 6228841
 4x 4211397	 4x 4211401	 1x 6134378	 5x 4211149	 2x 4211288	 1x 4579690	 1x 6424037
 10x 6126082	 4x 4211486	 2x 6420741	 2x 4211210	 2x 4221744	 1x 4211204	 1x 6398342
		 8x 6163990	 2x 4211225	 5x 4211151	 1x 4221590	 1x 6063447
		 4x 4211725	 2x 4211193	 1x 4211257	 2x 6326103	 4x 6291040
				 7x 6196221	 8x 6055145	 3x 6064188

2x
6395635

2x
6364352

3x
6464199

12x
6218047

4x
4490599

22x
6186672

2x
6335111

8x
6212377

2x
6338242

30x
6449109



 [LEGO.com/service](https://www.LEGO.com/service)

2x
6375358

1x
6372427

7x
6190252

1x
6400656

1x
6327553

1x
6477142

1x
6173139

1x
6056774

8x
6083975

1x
6370621

2x
6452472

1x
4585493

23x
6459521

1x
6451126

2x
6310366

4x
6296061

3x
6102990

2x
6433733

1x
6435640

1x
6467618

1x
6435310

1x
6394960

1x
6102984

2x
6287309

12x
6275872

8x
4653988

4x
6424641

8x
6346764

7x
6133728

4x
6250001

3x
6210675

2x
6337197

4x
6453350

1x
6210601

18x
6454456

1x
4653970

2x
6348142

4x
6335566

6x
6119107

2x
4619513

2x
4625036

9x
6146926

2x
6411330

1x
4583299

1x
4541496

4x
6411595



YOU COULD WIN



YOU COULD WIN

Your feedback will help shape the future development of this product series.

Visit:

DU KÖNNTEST GEWINNEN

Dein Feedback trägt zur Weiterentwicklung dieser Produktreihe bei.

Geh auf:

VOUS POURRIEZ GAGNER

Vos commentaires nous aideront à concevoir les futurs produits de cette gamme.

Visitez :

POTRESTI VINCERE TU

La tua opinione ci aiuterà a migliorare la creazione futura di questa linea di prodotti.

Visita:

PUEDES GANAR

Tu opinión contribuirá al futuro de esta serie de productos.

Visita:

轻松获奖

您的反馈将有助于我们在今后改进本产品系列。

请访问:

[LEGO.com/productfeedback](https://www.lego.com/productfeedback)

You also have the chance to win a LEGO® set.

Terms and conditions apply.*

Außerdem hast du die Chance, ein LEGO® Set zu gewinnen.

Es gelten die Teilnahmebedingungen.*

Vous pourriez également gagner un ensemble LEGO®.

Des conditions s'appliquent.*

Hai anche la possibilità di vincere un set LEGO®.

Termini e condizioni sono applicabili.*

También tienes la oportunidad de ganar un set LEGO®.

Aplican términos y condiciones.*

您还有机会赢取乐高®套装。

条款和条件适用。*

*[LEGO.com/productfeedback-terms](https://www.lego.com/productfeedback-terms)

ORIENT EXPRESS



LEGO and the LEGO logo are trademarks of the LEGO Group. ©2023 The LEGO Group.
ORIENT EXPRESS™ is a registered trade mark of Orient Express. All rights reserved.